

# PRINTRONIX®

---

## *Administrator's Manual*



---

*P8000 Line Matrix Printers  
Cartridge Ribbon Printer Series*

## READ THIS SOFTWARE LICENSE AGREEMENT BEFORE USING THIS PRINTER

### Software License Agreement

CAREFULLY READ THE FOLLOWING TERMS AND CONDITIONS BEFORE USING THIS PRINTER. USING THIS PRINTER INDICATES YOUR ACCEPTANCE OF THESE TERMS AND CONDITIONS. IF YOU DO NOT AGREE TO THESE TERMS AND CONDITIONS, PROMPTLY RETURN THE PRINTER AND ALL ACCOMPANYING HARDWARE AND WRITTEN MATERIALS TO THE PLACE YOU OBTAINED THEM, AND YOUR MONEY WILL BE REFUNDED.

### Definitions.

"Software" shall mean the digitally encoded, machine-readable data and program. The term "Software Product" includes the Software resident in the printer and its documentation. The Software Product is licensed (not sold) to you, and Printronix, LLC either owns or licenses from other vendors who own, all copyright, trade secret, patent and other proprietary rights in the Software Product.

### License.

1. Authorized Use. You agree to accept a non-exclusive license to use the Software resident in the printer solely for your own customary business or personal purposes.
2. Restrictions.
  - a. To protect the proprietary rights of Printronix, LLC, you agree to maintain the Software Product and other proprietary information concerning the typefaces in strict confidence.
  - b. You agree not to duplicate or copy the Software Product.
  - c. You shall not sublicense, sell, lease, or otherwise transfer all or any portion of the Software Product separate from the printer, without the prior written consent of Printronix, LLC.
  - d. You may not modify or prepare derivative works of the Software Product.
  - e. You may not transmit the Software Product over a network, by telephone, or electronically using any means; or reverse engineer, decompile or disassemble the Software.
  - f. You agree to keep confidential and use your best efforts to prevent and protect the contents of the Software Product from unauthorized disclosure or use.
3. Transfer. You may transfer the Software Product with the printer, but only if the recipient agrees to accept the terms and conditions of this Agreement. Your license is automatically terminated if you transfer the Software Product and printer.

### Limited Software Product Warranty

Printronix, LLC warrants that for ninety (90) days after delivery, the Software will perform in accordance with specifications published by Printronix, LLC. Printronix, LLC does not warrant that the Software is free from all bugs, errors and omissions.

### Remedy

Your exclusive remedy and the sole liability of Printronix, LLC in connection with the Software is replacement of defective software with a copy of the same version and revision level.

### Disclaimer of Warranties and Limitation of Remedies

1. THE PARTIES AGREE THAT ALL OTHER WARRANTIES, EXPRESS OR IMPLIED, INCLUDING WARRANTIES OF FITNESS FOR A PARTICULAR PURPOSE AND MERCHANTABILITY ARE EXCLUDED. Printronix, LLC does not warrant that the functions contained in the Software will meet your requirements or that the operation of the Software will be uninterrupted or error free. Printronix, LLC reserves the right to make changes and/or improvements in the Software without notice at any time.
2. IN NO EVENT WILL PRINTRONIX, LLC BE LIABLE FOR LOST PROFITS, LOST DATA, BUSINESS INTERRUPTIONS, OR ANY OTHER DIRECT, INDIRECT, INCIDENTAL OR CONSEQUENTIAL DAMAGES ARISING OUT OF THE USE OF OR INABILITY TO USE THIS PRODUCT, EVEN IF PRINTRONIX, LLC HAS BEEN ADVISED OF THE POSSIBILITY OF SUCH DAMAGES, OR ANY DAMAGES CAUSED BY THE ABUSE OR MANIPULATION OF THE SOFTWARE. SOME STATES DO NOT ALLOW THE EXCLUSION OR LIMITATION OF LIABILITY FOR CONSEQUENTIAL OR INCIDENTAL DAMAGES, SO THE ABOVE LIMITATION MAY NOT APPLY TO YOU.
3. Printronix, LLC will not be liable for any loss or damage caused by delay in furnishing a Software Product or any other performance under this Agreement.
4. Our entire liability and your exclusive remedies for our liability of any kind (including liability for negligence except liability for personal injury caused solely by our negligence) for the Software Product covered by this Agreement and all other performance or nonperformance by us under or related to this Agreement are limited to the remedies specified by this Agreement.
5. California law governs this Agreement.

### Termination of License Agreement

This License shall continue until terminated. This license may be terminated by agreement between you and Printronix, LLC or by Printronix, LLC. If you fail to comply with the terms of this License and such failure is not corrected within thirty (30) days after notice. When this License is terminated, you shall return to the place you obtained them, the printer and all copies of the Software and documentation.

### U.S. Government Restricted Rights

Use, duplication or disclosure by the Government is subject to restrictions as set forth in the Rights in Technical Data and Computer Software clause at FAR 242.227-7013, subdivision (b) (3) (ii) or subparagraph (c) (1) (ii), as appropriate. Further use, duplication or disclosure is subject to restrictions applicable to restricted rights software as set forth in FAR 52.227-19 (c) (2).

### **Acknowledgement of Terms and Conditions**

YOU ACKNOWLEDGE THAT YOU HAVE READ THIS AGREEMENT, UNDERSTAND IT, AND AGREE TO BE BOUND BY ITS TERMS AND CONDITIONS. NEITHER PARTY SHALL BE BOUND BY ANY STATEMENT OR REPRESENTATION NOT CONTAINED IN THIS AGREEMENT. NO CHANGE IN THIS AGREEMENT IS EFFECTIVE UNLESS WRITTEN AND SIGNED BY PROPERLY AUTHORIZED REPRESENTATIVES OF EACH PARTY. BY USING THIS PRINTER, YOU AGREE TO ACCEPT THE TERMS AND CONDITIONS OF THIS AGREEMENT.



This document contains proprietary information protected by copyright. No part of this document may be reproduced, copied, translated, or incorporated in any other material in any form or by any means, whether manual, graphic, electronic, mechanical, or otherwise, without the prior written consent of Printronix.

Printronix makes no representations or warranties of any kind regarding this material, including, but not limited to, implied warranties of merchantability and fitness for a particular purpose. Printronix shall not be held responsible for errors contained herein or any omissions from this material or for any damages, whether direct or indirect, incidental or consequential, in connection with the furnishing, distribution, performance, or use of this material. The information in this manual is subject to change without notice.

COPYRIGHT 2013 PRINTRONIX, LLC

### **Trademark Acknowledgements**

ANSI is a registered trademark of the American National Standards Institute, Inc.

Artifex, the Artifex logo  Ghostscript, and the Ghostscript logo  are registered trademarks of Artifex Software, Inc.

PostScript is a trademark of Adobe Systems Incorporated.

Centronics is a registered trademark of Genicom Corporation.

CSA is a registered certification mark of the Canadian Standards Association.

Dataproducts is a registered trademark of Dataproducts Corporation.

EIA is a registered service mark of the Electronic Industries Association.

Epson is a registered trademark of Seiko Epson Corporation.

Ethernet is a trademark of Xerox Corporation.

IBM, AS/400, and Proprinter are registered trademarks, and Intelligent Printer Data Stream and IPDS are trademarks of International Business Machines Corporation.

IEEE is a registered service mark of the Institute of Electrical and Electronics Engineers, Inc.

Printronix, PGL, LinePrinter Plus, and IGP are registered trademarks, and P8005, P8010, P8015, P8205, P8210, P8215, P8220, and SureStak are trademarks of Printronix, LLC.

QMS is a registered trademark, and Code V is a trademark of Quality Micro Systems, Inc.

TUV is a registered certification mark of TUV Rheinland of North America, Inc.

UL is a registered certification mark of Underwriters Laboratories, Inc.



## Table of Contents

<b>1</b>	<b>Introduction.....</b>	<b>11</b>
	Printer Overview.....	11
	Printronix P8000 Series Cartridge Ribbon Printers (CRP).....	11
	Consumable Monitoring with PrintNet Enterprise.....	13
	Protocols and Emulations.....	13
	Graphics Enhancements.....	13
	Taking Care of Your Printer.....	14
	Conventions in this Manual.....	14
	Warnings and Special Information.....	14
	Related Documents.....	14
<b>2</b>	<b>Setting Up The Printer.....</b>	<b>17</b>
	Before You Begin.....	17
	Power Requirements.....	17
	Select a Site.....	17
	Printer Dimensions.....	18
	Printer Component Locations.....	21
<b>3</b>	<b>Operating The Printer.....</b>	<b>23</b>
	Powering on the Printer.....	23
	Operating Modes.....	23
	The Control Panel.....	24
	Control Panel Keys.....	25
	Cancel a Print Job.....	27
	Operational Procedures.....	28
	Reload Paper.....	28
	Unload Paper.....	35
	Integrated Print Management System.....	36
	Output Darkness.....	37
	Loading a Used Ribbon Cartridge.....	37
	Lighter or Darker Print.....	37
	Changing Ribbon Cartridge.....	37
<b>4</b>	<b>The Configuration Menus.....</b>	<b>41</b>
	Configuration Overview.....	41
	First Power On.....	41
	Main Menu.....	41
	Changing Parameter Settings.....	41
	Saving Parameter Settings.....	42
	Default and Custom Configurations.....	42
	Navigating the Menus.....	42
	Top Level Menu Overview.....	43

Changing Parameters Example .....	46
Auto Save Configuration .....	49
Saving Your New Configuration.....	49
Optimizing Print Quality .....	54
Optimizing Print Speed .....	55
Dynamic Menu Options .....	55
Active Emulations .....	56
P8000 Standard Firmware .....	58
P8000 TN Firmware .....	59
P8000 PCL-II Firmware .....	60
P8000 LG Firmware .....	61
P8000 ANSI Firmware .....	62
OpenPrint P8000 Standard Postscript/PDF Firmware .....	63
OpenPrint P8000 HD Postscript/PDF Firmware .....	64
H-Series Firmware .....	65
OKI Menu .....	66
P8000 Indian and Arabic Language Firmware .....	68
QUICK SETUP Menu .....	69
CONFIG. CONTROL Menu .....	76
HOST INTERFACE Menu .....	77
Auto Switching Submenu .....	78
IEEE 1284 Parallel (Bidirectional) Submenu .....	79
Centronics (Parallel) Submenu .....	81
Serial Submenu .....	83
NETWORK SETUP Menu .....	87
Ethernet Address .....	87
Ethernet Params .....	88
ACTIVE IGP EMUL and ACTIVE EMULATIONS.....	89
EMULATION Menu.....	91
3270 Params.....	92
5250 Params.....	98
LinePrinter Plus Emulation (ASCII, Indian Language).....	102
LinePrinter Plus Emulation (H-Series Hanzi GB).....	104
LinePrinter Plus Emulation (H-Series Hanzi Big5).....	105
LinePrinter Plus Emulation (H-Series Kanji) .....	106
LQ-1600K Emulation.....	107
LinePrinter Plus Emulation (H-Series Hangul).....	110
KS Emulation .....	111
KSSM Emulation .....	112
Page Format Submenu (H-Series) .....	114
P-Series Emulation .....	122
P-Series Character Set Menu .....	125
Indian Language Character Set Menu.....	126

P-Series XQ Emulation .....	128
Serial Matrix Emulation .....	130
Serial Matrix Character Set Menu .....	132
Proprinter XL Emulation .....	133
Proprinter XL Character Sets Menu .....	135
Epson FX Emulation .....	136
Epson FX Character Set Menu .....	138
ANSI Emulation .....	139
IGP/PGL Submenu .....	147
IGP/PGL Font Set Menu .....	155
IGP/VGL Emulation .....	156
IGP/VGL Submenu .....	157
IGP/VGL Graphics Options Submenu .....	158
IGP/VGL Font Set Menu .....	165
IPDS Emulation .....	166
PCL – II Emulation .....	170
LG Emulation .....	174
Arabic Context Analyzer .....	177
Arabization Menus .....	185
OpenPrint POSTSCRIPT/PDF Emulation .....	185
Postscript/PDF Interpreter .....	186
PRINTER CONTROL Menu .....	190
ADVANCED USER Menu .....	194
SURE SCAN Submenu .....	195
DIAGNOSTICS Menu .....	208
Printer Mgmt Menu .....	211
<b>5 Interfaces .....</b>	<b>213</b>
Overview .....	213
RS-232 Serial Interface .....	215
USB .....	216
Centronics Parallel Interface .....	216
Centronics Parallel Interface Signals .....	217
IEEE 1284 Parallel Interface .....	217
Compatibility Mode .....	217
Nibble Mode .....	217
Byte Mode .....	217
Signals .....	217
Ethernet .....	219
<b>6 Reprogramming the Security Key .....</b>	<b>221</b>
Reprogramming the Security Key .....	221
How to Program the Security Key .....	221

<b>7</b>	<b>Downloading Firmware .....</b>	<b>223</b>
	Firmware File Types (.prg) and (.exe) .....	224
	Web Page Download .....	225
	Windows Driver Download .....	227
	Automatic Download (.exe) .....	228
	Manual Two-Key Download Sequence .....	230
	Manual Three-Key Download Sequence.....	230
	Sending Firmware in Download Mode .....	231
	Sending Firmware via Ethernet (LPR) .....	231
	Sending Firmware via USB.....	231
	Installing a Microsoft Loopback Adapter .....	232
	Sending Firmware via Parallel .....	237
	Sending Firmware via Serial .....	237
	Downloading Files to the Main File System .....	237
	Filename Extensions Not Shown in Menus.....	238
	File Properties Not Shown in Menus .....	239
	Web Page Download.....	239
	PTX_SETUP Download.....	241
	Manual Two-Key Download .....	241
	Downloading Files to the SD Card .....	242
	Using TrueType Fonts.....	242
	Downloading TrueType Fonts.....	242
	Select and Print Downloaded TrueType Fonts .....	244
	Demo Facility .....	245
<b>8</b>	<b>Troubleshooting.....</b>	<b>247</b>
	Cleaning Requirements.....	247
	Exterior Cleaning .....	247
	Interior Cleaning.....	247
	Diagnosing Problems .....	249
	Bar Code Verification .....	249
	Printing a Hex Dump.....	250
	Most Frequent Problems and Solutions .....	252
	Diagnostics for EXX, BAD NVM, or ILL NVM Errors.....	252
	Fault Messages (ASCII in Alphabetical Order) .....	253
	Fault Messages (H-Series with Numerical Prefix).....	273
<b>A</b>	<b>Printer Specifications .....</b>	<b>291</b>
	Ribbon Cartridge Specifications .....	291
	ASCII.....	291
	HD and H-Series .....	291
	Paper Specifications.....	291
	Labels .....	292



Printer Weight and Dimensions .....	292
Environmental Characteristics .....	292
Acoustic Noise Level .....	292
Electrical Characteristics .....	293
Input Voltage (ASCII Models) .....	293
Input Voltage (H-Series Models).....	293
Interfaces .....	294
Printing Speed .....	294
<b>B Standard ASCII Character Set.....</b>	<b>295</b>
<b>C Zero Tear Pedestal Printer.....</b>	<b>297</b>
Overview.....	297
Operation.....	298
Position the Paper Input and Adjust the Paper Guides .....	298
Load Paper.....	300
Position the Paper Out Sensor .....	302
Set the Tear Bar Distance.....	303
Set the Top of Form .....	304
ZTP SETTINGS Menu.....	305
Performance Limitations.....	306
<b>D Quick Change Memory Card (QCMC) .....</b>	<b>309</b>
Overview.....	309
Installing the QCMC .....	310
Saving the Printer's Configuration to the QCMC.....	311
Copying the QCMC "Snapshot" Image to a Second Printer.....	312
Updating the QCMC Image .....	314
Erasing the QCMC Image .....	314
<b>E PTX_SETUP Commands.....</b>	<b>315</b>
Overview.....	315
The PTX_SETUP Commands .....	315
General Commands.....	315
Line Matrix Commands .....	321
<b>F Customer Support.....</b>	<b>323</b>
Printronix Customer Support Center .....	323
Printronix Supplies Department .....	323
Corporate Offices.....	324
<b>G Communication Notices .....</b>	<b>325</b>
Notices.....	325
Communication Statements .....	326
Software License Agreement .....	332



# 1 *Introduction*

## **Printer Overview**

This chapter provides a general overview of your printer and the conventions used within this manual.

### **Printronix P8000 Series Cartridge Ribbon Printers (CRP)**

Printronix® has been the global leader in industrial printing solutions for over 30 years, earning a reputation for designing and manufacturing leading edge products and delivering them to market with unsurpassed service and support.

The Printronix P8000™ Line Matrix Printing Platform extends the series of technology innovations that cement Printronix's leadership position. Line matrix printing is Printronix's flagship technology, and it remains the workhorse solution for supply-chain and back-office printing applications because of its reliability, lower cost of ownership and flexibility of printing applications.

- Most reliable printer ever – provides more up time and lower operating costs
- Cartridge ribbons – deliver darker image, last longer, and costs less to operate than other print technologies
- Integrated print management system – provides precise control over print quality, print costs, and job planning
- Cabinet, pedestal, or zero tear pedestal (ZTP) styles – best user access and forms handling flexibility
- Unsurpassed ease of use – larger graphics LCD simplifies operation and enhances productivity

**Table 1 P8000 Series Models and Configurations**

<b>Model Number</b>	<b>Configuration</b>	<b>Print Speed (Lines per Minute)</b>
LMPPLS (Line Matrix Printer Pedestal Low Speed)	P8003H	300
	P8003HZT	300
	P8005	500
	P8005ZT	500
	P8010	1000
	P8010ZT	1000
LMPPHS (Line Matrix Printer Pedestal High Speed)	P8006	600
	P8006HZT	600
	P8000HD	600
	P8000HDZT	600
LMPCLS (Line Matrix Printer Cabinet Low Speed)	P8203H	300
	P8205	500
	P8210	1000
LMPCHS (Line Matrix Printer Cabinet High Speed)	P8215	1500
	P8220	2000
	P8206H	600
	P8208H	800
	P8200HD	800

Three printer configurations are available:

**Cabinet (P82XX, P8200HD, or P82XXH)**

- The enclosed cabinet models provide for near silent operation, making these printers perfectly suitable for use in the quietest of office environments.
- Provides the best paper handling for large print runs. All paper input and output is contained inside the cabinet and protected from bumping and contamination.
- Highly effective combination of moveable fences and chains allows for precise stacking all the way up to a full box of paper.
- Available in the following print speeds:  
 ASCII – 500, 1000, 1500 and 2000 line per minute models  
 H-Series – 600 and 800 line per minute models  
 OpenPrint HD (available only for cabinet models)

### **Pedestal (P80XX, P8000HD, or P80XXH)**

- The pedestal model has a clamshell design that allows easy access to all controls providing faster ribbon replacements and easier paper loading.
- Oversized casters are standard making movement easy.
- Available in the following print speeds:  
ASCII – 500 and 1000 line per minute models H-Series – 300 and 600 line per minute models

### **Zero Tear Pedestal (P80XXZT or P80XXHZT)**

- Special push tractor configuration enables printing from the very first to the very last line of a form and then tear-off with no forms lost
- The elimination of wasted forms between jobs can yield significant savings.
- An ideal solution for supply-chain and back-office applications.
- Available in the following print speeds:  
ASCII – 500 and 1000 line per minute models H-Series – 300 and 600 line per minute models

## **Consumable Monitoring with PrintNet Enterprise**

The Integrated Print Management System works with PrintNet Enterprise (PNE). PNE allows a system administrator to remotely view the current consumable status of all printers. PNE can be configured to deliver alerts on all consumable warnings. When a ribbon reaches the low state, PNE notifies the system administrator remotely via an automated e-mail alert of the low condition. This allows corrective action to be taken before the ribbon reaches its end of life. If the ribbon is not changed, an alert will again be initiated once the ribbon reaches the 0% end point. Refer to your PrintNet Enterprise Remote Management Software manual for details.

## **Protocols and Emulations**

A protocol is a set of rules governing the exchange of information between the printer and its host computer. These rules consist of codes that manipulate and print data and allow for machine-to-machine communication. A printer and its host computer must use the same protocol. As used in this manual, protocol and emulation mean the same thing.

Most impact printers use single ASCII character codes to print text, numbers, and punctuation marks. Some characters are defined as control codes. Control codes instruct the printer to perform specific functions, such as underlining text, printing subscripts, setting page margins, etc. The difference between most printer protocols is the characters used to create control codes and the ways in which these characters are formatted.

When the printer executes the character and control codes of a particular printer protocol, it is emulating that printer.

## **Graphics Enhancements**

The IGP/PGL and IGP/VGL emulations allow you to create and store forms, generate logos, bar codes, expanded characters, and create other graphics. Alphanumeric and bar code data are added as the form is printed.

These emulations are available as factory-installed or field-installed options, except on H-series models. For more information, contact your authorized service representative.

## Taking Care of Your Printer

Your printer will produce high print quality jobs if it is well taken care of. Periodic cleaning, handling the printer properly, and using the correct printer supplies such as ribbon and paper ensures optimum performance. Chapter 8 explains how to clean the printer, and printer supplies are listed in Appendix A.

## Conventions in this Manual

Control panel keys and indicators are highlighted in **UPPERCASE BOLD PRINT**.

**Example:** Press the **CANCEL** key, then press the **ONLINE** key.

Quotation marks (“ ”) indicate messages on the Liquid Crystal Display (LCD).

**Example:** Press the **ONLINE** key. “OFFLINE” appears on the LCD.

The + (plus) symbol represents key combinations.

**Example:** “Press  $\triangle$  +  $\nabla$ ” means press the  $\triangle$  (UP) key and the  $\nabla$  (DOWN) key at the same time.

## Warnings and Special Information

Read and comply with all information highlighted under special headings:

**WARNING** A warning notice calls attention to a condition that could harm you.

**CAUTION** A caution notice calls attention to a condition that could damage the printer.

**IMPORTANT** Information vital to proper operation of the printer.

**NOTE:** A note gives you helpful tips about printer operation and maintenance.

## Related Documents

- *Quick Reference Guide* — Explains how to set up the printer for basic operation (load ribbon cartridge and media, and clear paper jams).
- *Maintenance Manual* — Explains how to maintain and repair the line matrix printer at the field service level of maintenance.
- *ANSI Programmer's Reference Manual* — Provides host control codes and character sets for the ANSI emulation.
- *PCL<sup>®</sup>-II/LinePrinter Plus Programmer's Reference Manual* — Provides host control codes and character sets for the PCL-II emulation.
- *LG Programmer's Reference Manual* — Provides host control codes and character sets for the LG emulation.
- *Character Sets Reference Manual* — Information about and examples of the character sets available in line matrix printers.
- *IGP/PGL Programmer's Reference Manual* — Provides information used with the optional IGP Printronix emulation enhancement feature.
- *IGP/VGL Programmer's Reference Manual* — Provides information used with the optional Code V™ emulation enhancement feature.

- *PrintNet Ethernet User's Manual* — Information about network protocols, configuration, and operation.
- *IPDS Emulation Programmer's Reference Manual* — Provides an overview of Intelligent Printer Data Stream™ (IPDS) features, commands, and diagnostics.
- *LinePrinter Plus Programmer's Reference Manual* — Covers the host control codes for the LinePrinter Plus emulation.
- *LQ-1600K Emulation For The P8000 H-Series Of Line Matrix Printers Programmer's Reference Manual* — Covers the host control codes for the LQ-1600K emulation.
- *KS Programmer's Reference Manual* — Covers the host control codes for the KS emulation.
- *KSSM Programmer's Reference Manual* — Covers the host control codes for the KSSM emulation.
- *Arabic Programmer's Reference Manual* — Covers the host control codes for the Arabic emulation used within the Arabic Language firmware.





# 2 *Setting Up The Printer*

## Before You Begin

Read this chapter carefully before installing and operating the printer. The printer is easy to install. However, for your safety and to protect valuable equipment, perform all the procedures in this chapter in the order presented.

## Power Requirements

The printer must be connected to a power supply outlet that supplies 90 to 264 volts AC at its upper and lower limits. These limits take into account normal voltage sags and surges created on the nominal line voltage by other AC power loads associated with the AC distribution line. The printer automatically senses and adjusts itself to conform to the correct voltage range.

Primary circuit protection is provided by the AC source protection device. Consult an electrician if printer operation affects local electrical lines.

**IMPORTANT** Printer power should be supplied from a separate AC circuit protected at 20 amperes maximum for 100 - 240 volts at 50 or 60 Hertz.

## Select a Site

Select a printer site that meets all of the following requirements:

- Permits complete opening of the printer cover and doors.
- For cabinet models, allows at least three feet of clearance behind the printer. (This permits air to circulate freely around the printer and provides access to the paper stacking area.)
- For pedestal models, DO NOT place the side of the printer (inlet and exit air vents) against a wall or other object. A minimum of 6 inch spacing is recommended.
- Has a standard power outlet that supplies 100-135 Volts AC or 178-240 Volts AC power, at 47 to 63 Hz.
- Is relatively dust-free.
- Has a temperature range of 10° C to 40° C (50° F to 104° F) and a relative humidity from 15% to 90% non-condensing.
- Is located within the maximum allowable cable length to the host computer. This distance depends on the type of interface you plan to use, as shown in Table 2.

**Table 2 Maximum Interface Connection Cable Length**

Interface Type	Maximum Cable Length
Centronics Parallel	5 meters (15 feet)
IEEE 1284 Parallel	10 meters (32 feet)
Serial RS-232	15 meters (50 feet)
USB 2.0 Universal Serial Bus	5 meters (15 feet)
Twisted Pair / Type 3	300 meters (985 feet)
Ethernet 10/100Base-T	100 meters (328 feet)

## Printer Dimensions

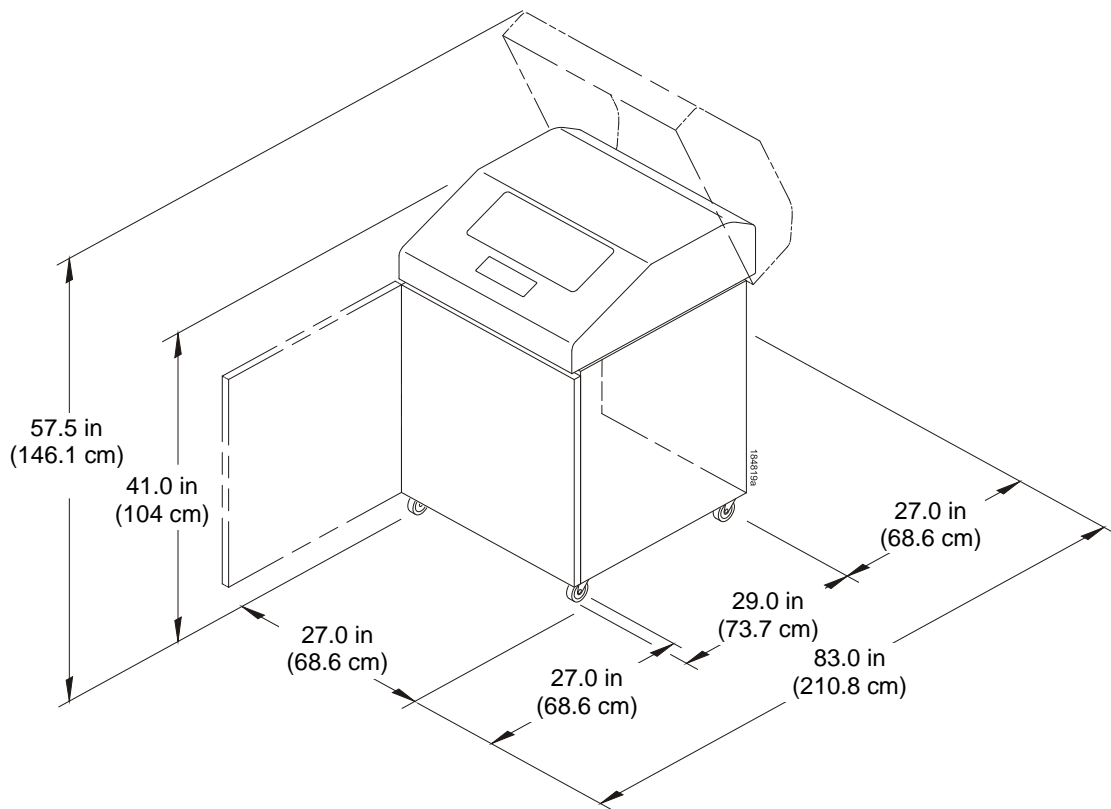

**Figure 1 Cabinet Model**

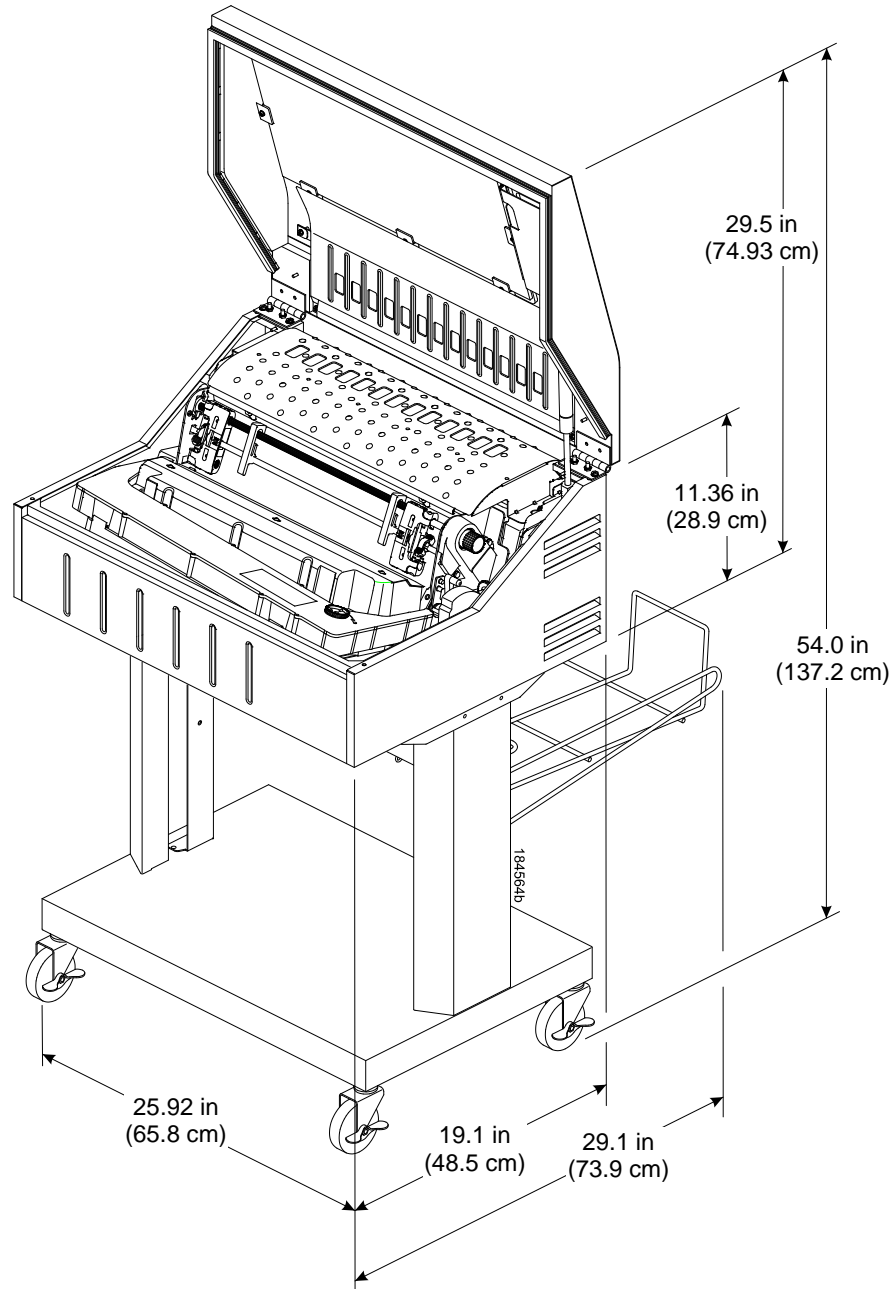

**Figure 2 Pedestal Model**

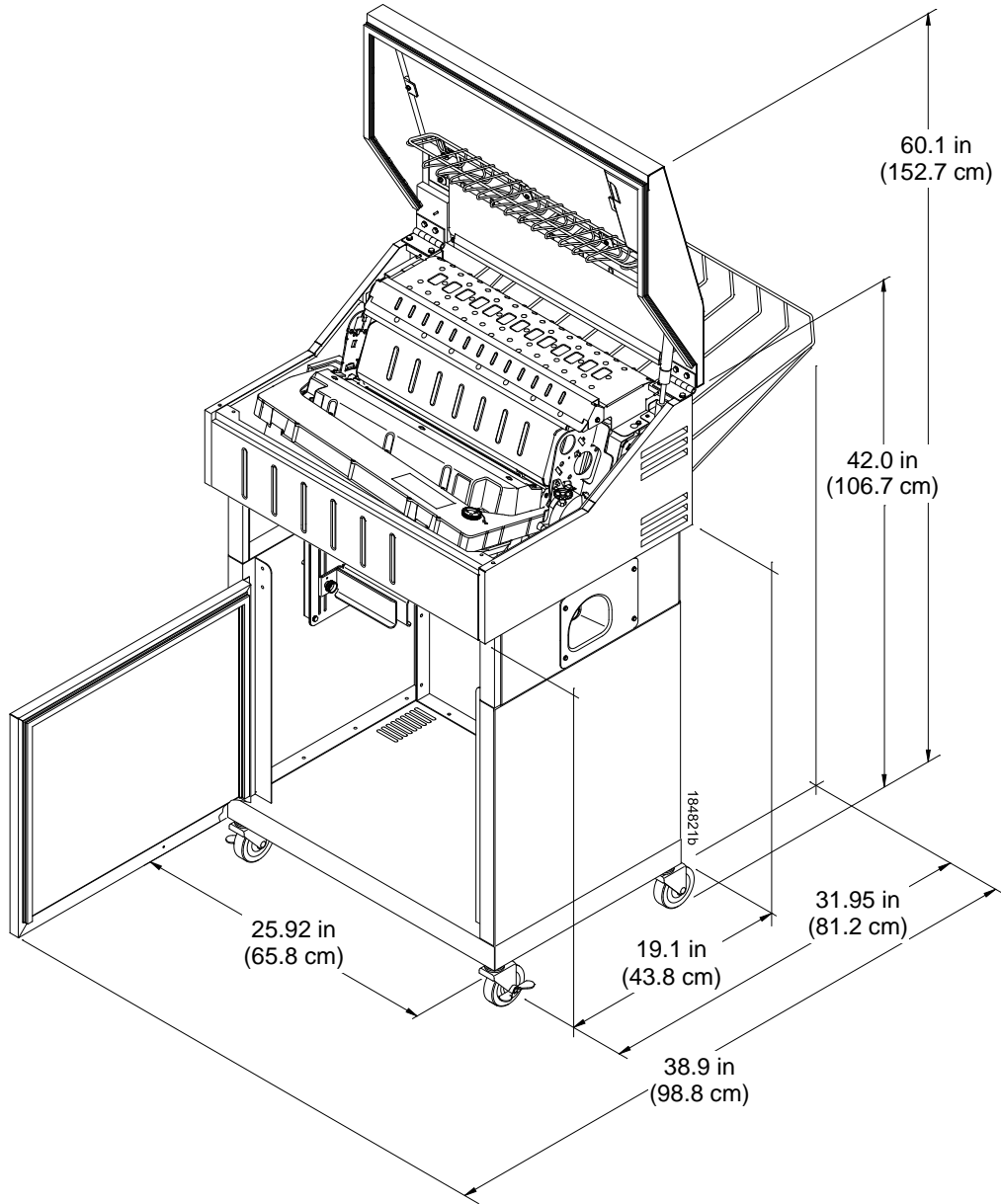

**Figure 3 Zero Tear Pedestal Model**

# Printer Component Locations

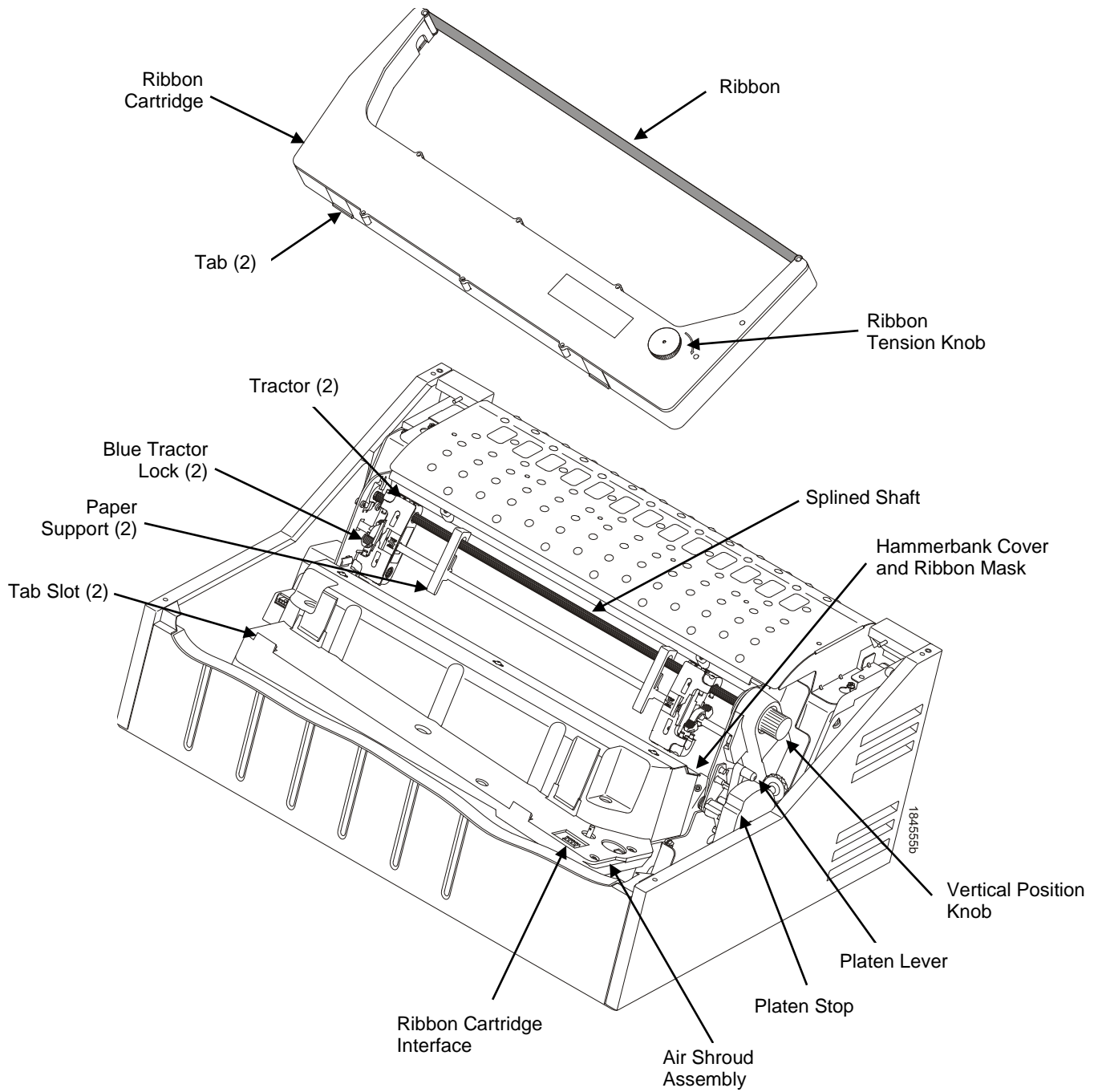

Figure 4 Printer Component Locations



# 3 *Operating The Printer*

## Powering on the Printer

When you power on the printer, it executes a self-test. The default power-up state is online. When the self-test completes and the software has initialized successfully, the status indicator light turns on, indicating the printer is online. The default value of the type of emulation you have installed appears in the LCD display. The ribbon life remaining is shown on the bottom of the LCD display.

If there is a fault during the self-test, the status indicator flashes and a specific fault message appears on the display (such as "LOAD PAPER"). The alarm also sounds if it is configured to do so. See "LCD Message Troubleshooting Table" on page 254 for information on fault messages and solutions.

## Operating Modes

**Online.** In online mode, the printer can receive and print data sent from the host. Pressing the **ONLINE** key toggles the printer from online to offline mode. The status indicator is lit in online mode.

**Offline.** In offline mode, you can perform operator functions, such as loading paper and setting top-of-form. Pressing the **ONLINE** key toggles the printer from offline to online mode. The status indicator is off in offline mode.

**Menu.** In offline mode, pressing **ENTER** moves the printer into Menu mode. In this mode, you can navigate through all menus and change the printer configuration. To return to offline mode, press the **ONLINE** key.

**Fault.** In fault mode, a condition exists which must be cleared before printing can continue. The status indicator flashes, the alarm beeps (if configured to sound), and a descriptive fault message displays.

The current operating mode can be selected via control panel keys or can result from routine operations such as powering on the printer.

# The Control Panel

Figure 5 shows the keys, displays, and indicators as they appear on the control panel. The following section provides the descriptions, and functions of the control panel keys.

Key combinations are indicated with the plus (+) sign. For example, "Press  $\Delta$  +  $\nabla$ " means to press the  $\Delta$  key and the  $\nabla$  key at the same time.

## Cabinet Model

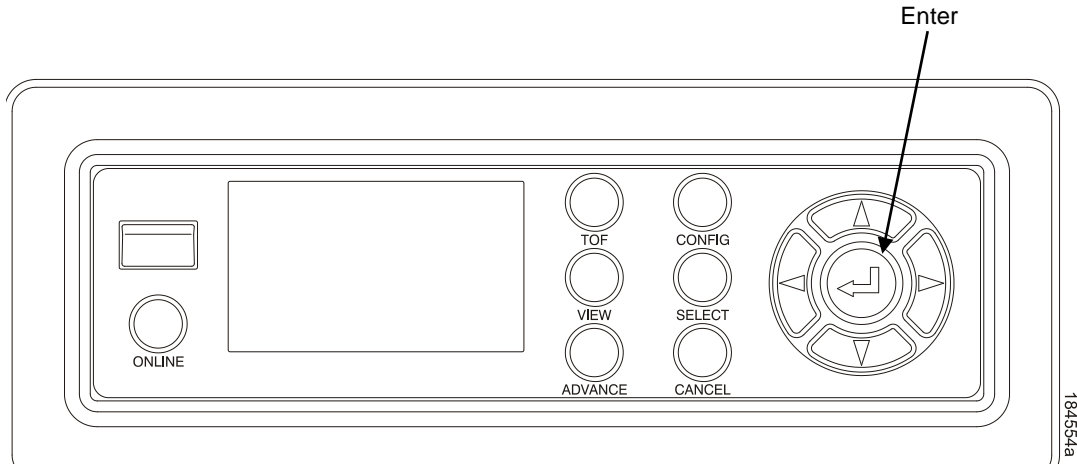

## Pedestal Model

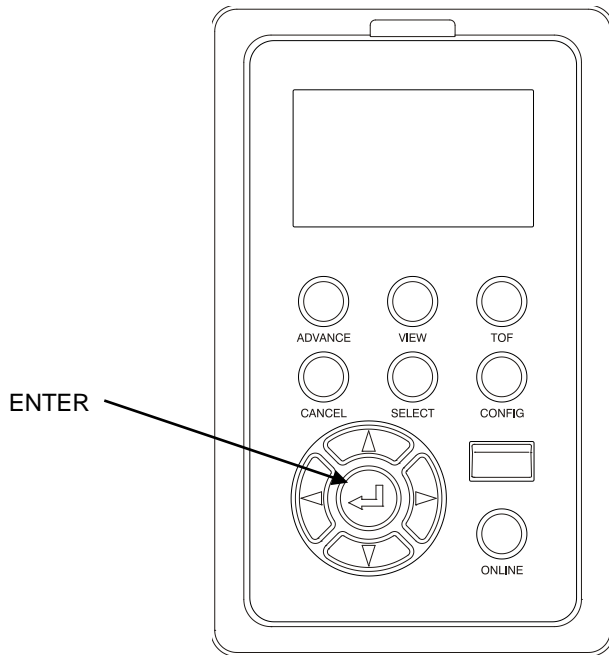

### Legend:

- TOF = Set TOF (Top of Form)
- VIEW = View/Eject
- ADVANCE = Paper Advance
- CONFIG = Print Config
- SELECT = Load Config/Print Mode <sup>1</sup>
- CANCEL = Cancel Job
- ONLINE = Online/Clear

### NOTE:

<sup>1</sup> Print Mode only available for H-Series printers.

**Figure 5 Control Panel**



## Control Panel Keys

### ONLINE

Toggles the printer between online and offline modes. The key performs the following in Online, Offline, Fault, and Menu modes:

- **Online Mode** – sets the printer to Offline Mode.
- **Offline Mode** – sets the printer to Online Mode.
- **Fault Mode** – causes the printer to recheck the faults; if the faults are cleared, the printer toggles to Offline Mode. If the fault condition is not corrected before pressing the ONLINE key, the fault message reappears.
- **Menu Mode** – sets the printer to Offline Mode.

**NOTE:** When changing to Online Mode, if the user has changed menu items without saving the changes in a configuration, the user will be prompted to save the changes.

### ADVANCE

Performs advance to top-of-form, as defined by the current active form length. The key works both online and offline.

- If online with data in the printer buffer, the data will print and then the paper will move to the next top-of-form.
- In the fault state, pressing ADVANCE will advance the paper. The first press moves to the top of the next available form. All subsequent presses advances one forms length as defined by the current active forms length.

### VIEW

When the printer is online or offline, pressing this key executes the view or eject function, depending on the setting of the menu View Function.

If online with data in the printer buffer, the data prints and the key functions as described below.

If in a fault state, this key will be ignored.

- **View Function** — When the View Function menu is set to Enable, pressing the VIEW key for a short time (less than 1/2 second) moves the last data printed to the tractor area for viewing. While in the view state, the message "Printer in View" displays, pressing the UP or DOWN arrow keys moves the paper up or down in 1/72 inch increments. This is done to align the image within a pre-printed form, for example. Refer to the UP and DOWN key functions for additional details on the microstep feature. Pressing VIEW a second time moves the paper back to the adjusted print position.
- **Eject Function** — When the VIEW key is pressed and the View Function menu is set to Disable, or when the View Function menu is set to Enable and the VIEW key is pressed for a long time (more than 1/2 second), the bottom of the last printed form will move to the tear bar position as set by the Tear Bar Dist. menu value. The message "READY TO TEAR/EJECT To Return" displays. While in this position, pressing the UP or DOWN arrow keys moves the paper up or down in 1/72 inch increments. Refer to the Up and Down key functions for additional details on the microstep feature. When the VIEW key is pressed a second time, the printer will move the paper either forward or backward to enable printing on the next available form.

### CANCEL

In offline mode, this key cancels all data in the print buffer, if enabled in the ADVANCED USER Menu (see page 194). The print buffer is cleared without printing any of the data and the current paper position is set as the top-of- form. If this function is disabled, the CANCEL key will be ignored.

- NOTE:** 1. Use of this key will cause loss of data.
2. For OpenPrint products, pressing the CANCEL key advances the paper to the next TOF.

## TOF

Sets the top-of-form on the printer. This key is active only when the printer is offline and will not operate if the printer is in a fault condition. The paper moves down to the print position and aligns to the top-of-form. Refer to the *User's Setup Guide* for complete instructions on how to set the top-of-form.

**NOTE:** If there is any data in the buffer, the paper will move to the last print position.

## CONFIG

In offline mode, CONFIG prints the current short configuration. This key requires a confirmation with the ENTER key; pressing any other key will exit from this function. See Configuration Overview on page 41 for an explanation of configuration menus.

## SELECT

In offline mode, this key allows for fast selection of any of the previously stored configurations. Pressing this key causes the printer to cycle through the following configuration load options: Factory, Cfg 1, Cfg 2, Cfg 3,..., Cfg 8.

For H-Series models, this key can be alternatively configured to select Print Mode.

## ENTER (↵)

When navigating the configuration menus, the Enter key (referenced by the symbol ↵) selects the currently displayed option value as the active value. An asterisk (\*) appears next to the active value on the display. Enter is also used for starting and stopping printer tests and generating a configuration printout.

**NOTE:** The Enter key must be unlocked to execute the select function.

See UP + DOWN, later in this section.

The ENTER key lock and unlock function can be configured to be a key combination other than △ + ▽ (see page 205).

- In Offline mode, pressing the Enter key places the printer in Menu mode. This will bring up a set of icons to select.
- In Menu mode (at the icon menu level), pressing the Enter key moves down into the menu tree of the highlighted icon.
- Within a menu tree: if the highlighted menu contains submenus instead of a selectable parameter, pressing the Enter key will go into the submenu. If the highlighted menu is a display only menu, then pressing the Enter key performs no function. If the highlighted menu has selectable parameters, pressing the unlocked Enter key will select the displayed parameter. An asterisk (\*) displays next to the selected parameter.
- If the highlighted menu is an executable menu, pressing the unlocked Enter key will cause the function associated with the executable menu to run. If the ENTER key is locked, pressing the Enter key for highlighted menus that are executable or contain selectable parameters will cause the message, THE ↵ KEY IS LOCKED, to display momentarily.

**NOTE:** Press the UP and Down keys at the same time to lock/unlock the ↵ key.

For special Network Address menus or String menus, pressing the Enter key will move down into a special multiple segment setting menu. Exit this menu by pressing Enter again to save changes or Cancel to exit without saving changes. This key is inactive in all other modes.

### **UP or DOWN ( $\Delta$ or $\nabla$ )**

Moves up or down between levels in the configuration menus and makes vertical forms adjustment. After pressing VIEW, press  $\Delta$  or  $\nabla$  to adjust the paper up or down in 1/72 inch increments for fine vertical forms alignment. When the printer is in offline mode, press  $\Delta$  or  $\nabla$  to move through levels in the configuration menus.

### **UP + DOWN ( $\Delta$ + $\nabla$ )**

Locks and unlocks the ENTER key.

**NOTE:** The ENTER key lock and unlock function can be configured to be a key combination other than  $\Delta$  +  $\nabla$  (see page 205).

### **PREV or NEXT ( $\triangleleft$ or $\triangleright$ )**

Moves between the options on the current level of configuration menu. In the configuration menu, press  $\triangleleft$  to scroll backward or press  $\triangleright$  to scroll forward through the menu selections on the same level.

### **PREV + NEXT ( $\triangleleft$ + $\triangleright$ )**

When both keys are pressed simultaneously, the printer will reset to the power-up configuration and reset its internal state (in offline mode).

### **$\Delta$ + ONLINE (IPDS Emulation only)**

In offline mode, press  $\Delta$  + ONLINE. If there is data in the printer buffer, the printer will be placed in online mode, print one page, and return to the offline mode. This action can be repeated until the end of a print job. Only one page prints each time you press  $\Delta$  + ONLINE. If there is no data in the printer buffer, the printer is placed in online mode.

In the fault state,  $\Delta$  + ONLINE does not work.

### **$\Delta$ + ADVANCE (IPDS Emulation only)**

In offline mode, press  $\Delta$  + ADVANCE. The printer will perform a reverse linefeed. If you hold down the  $\Delta$  + ADVANCE keys for longer than 1/2 second, the printer moves to the previous top-of-form position. If there is data in the printer buffer, the data does not print.

In the fault state,  $\Delta$  + ADVANCE does not work.

### **$\Delta$ + VIEW (IPDS Emulation only)**

In offline mode, press  $\Delta$  + VIEW. If there is data in the IPDS printer buffer, the printer will be placed in online mode, print one line, and return to offline mode. This action can be repeated until the end of the job. This function prints only one line of text. If the data is not text, only 1/6 inch prints. If there is no data in the printer buffer, the printer is placed in online mode for one second and then returns to offline mode.

In the fault state,  $\Delta$  + VIEW does not work.

### **Ribbon Life Indicator**

The bottom of the LCD displays the remaining life of the currently installed ribbon. The default settings for this feature should match the requirements for most applications; no special user setup is needed. If your particular application requires darker printing or can tolerate lighter printing, the ribbon end point can be adjusted as appropriate. Please refer Ribbon End Point on page 75.

### **Cancel a Print Job**

The procedure to cancel a print job depends on the printer emulation and your application software. Contact your system administrator for additional information.

1. If the printer is online, press **ONLINE** to place the printer in offline mode.
2. From the host system, stop the print job.

**NOTE:** If the print job is not stopped from the host system before pressing **CANCEL**, the print job continues with data missing when the printer returns to online mode. Exercise caution to prevent unwanted data loss occurrences, as this function deletes unprinted data in the printer. This function is active only in offline mode; the purpose of this function is to eliminate the necessity of printing unwanted data when print jobs are canceled.

3. Press **CANCEL**.

**NOTE:** You may need to enable the Cancel option on the front panel.

See **ADVANCED USER Menu** on page 194 for details.

4. Set the top-of-form. Refer to the *Quick Reference Guide*.

## Operational Procedures

This section contains routine printer operating procedures on how to:

- reload paper
- unload paper

### Reload Paper

Do this procedure when “LOAD PAPER” displays. (This message occurs when the last sheet of paper passes through the paper slot.) This procedure reloads paper without removing the last sheet of the old paper supply, while retaining the current top-of-form setting.

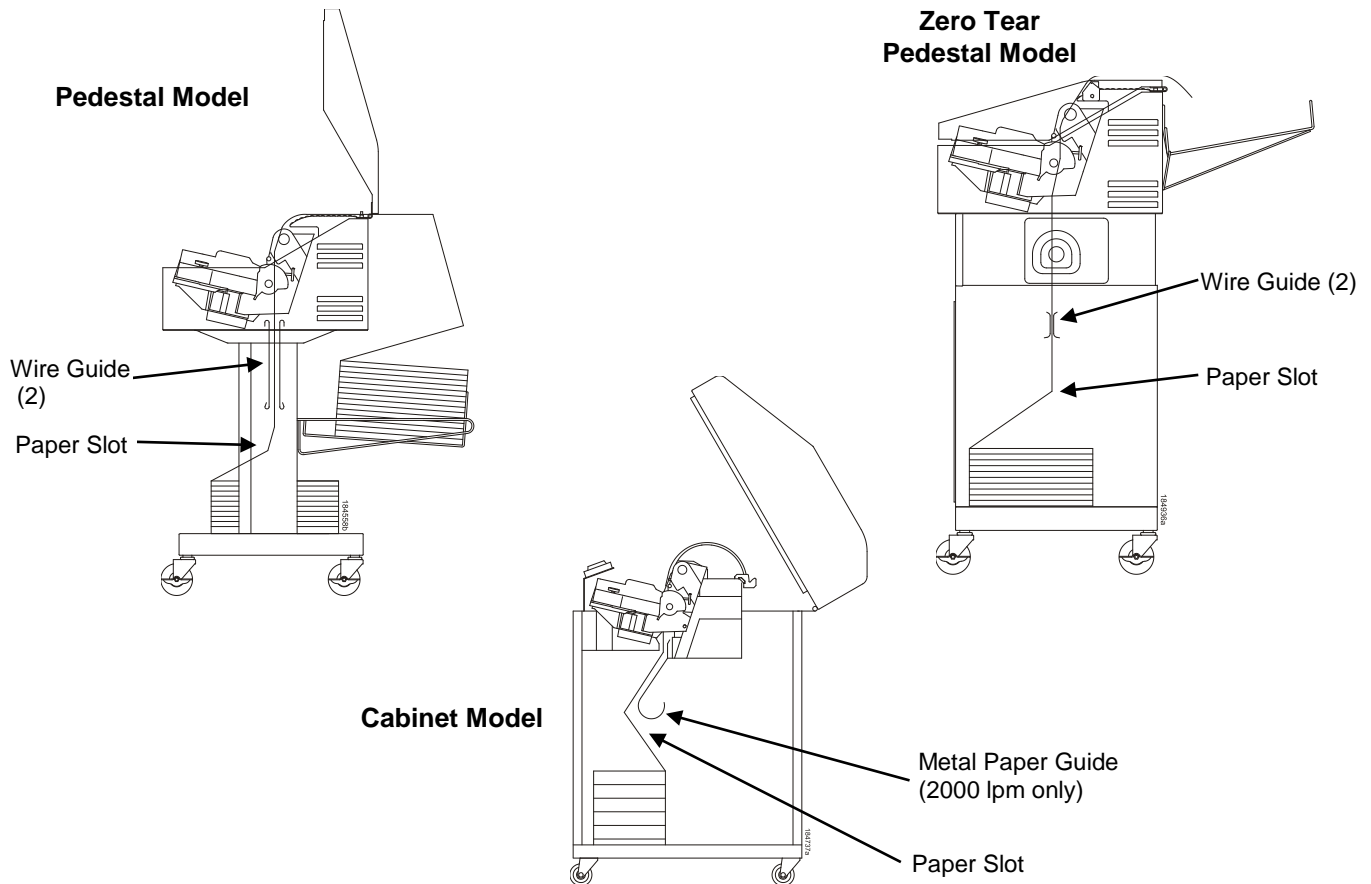

**Figure 6 Paper Slot Location**

1. Raise the printer cover. Raise the platen lever as far as it will go. (See Figure 4 on page 21 for the location of the lever.)

**NOTE:** Do not open tractor doors or remove the existing paper.

2. **Cabinet models:** open the front door and align the paper supply with the label on the floor.  
**Pedestal models:** place the paper supply on the floor of the printer, centered under the paper slot.  
**Zero Tear Pedestal models:** open the front door and place the paper supply inside the printer, on the floor of the cabinet.
3. Ensure the paper pulls freely.
4. Feed the paper up through the paper slot (see Figure 6). It may be easier to feed one corner of the new paper up through the slot first. When this corner can be grasped from the top, rotate the paper back to the normal position.

**NOTE:** If you are using thick, multi-part forms and are unable to load the new paper over the existing paper, go to step 15.

5. Hold the paper to prevent it from slipping down and through the paper slot.

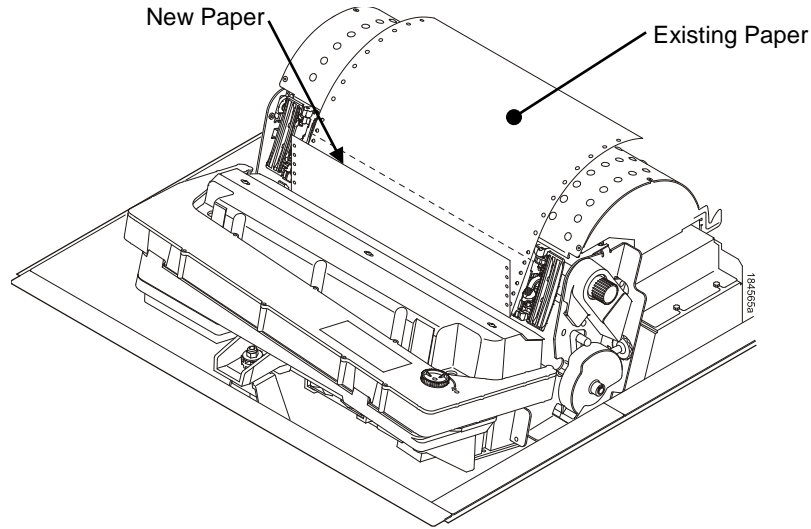

**Figure 7 Loading New Paper into the Printer**

6. Pull the new paper above and behind the ribbon mask, but in front of the existing paper. See Figure 4 on page 21 for the ribbon mask location. If necessary, gently press the existing paper back.
7. Align the top edge of the new paper with the top perforation of the existing paper.
8. Load the new paper over the existing paper. Open and load the tractors one at a time to prevent the paper from slipping.

**NOTE:** Make sure that the top edge of the new paper lines up with the top horizontal perforation of the last page.

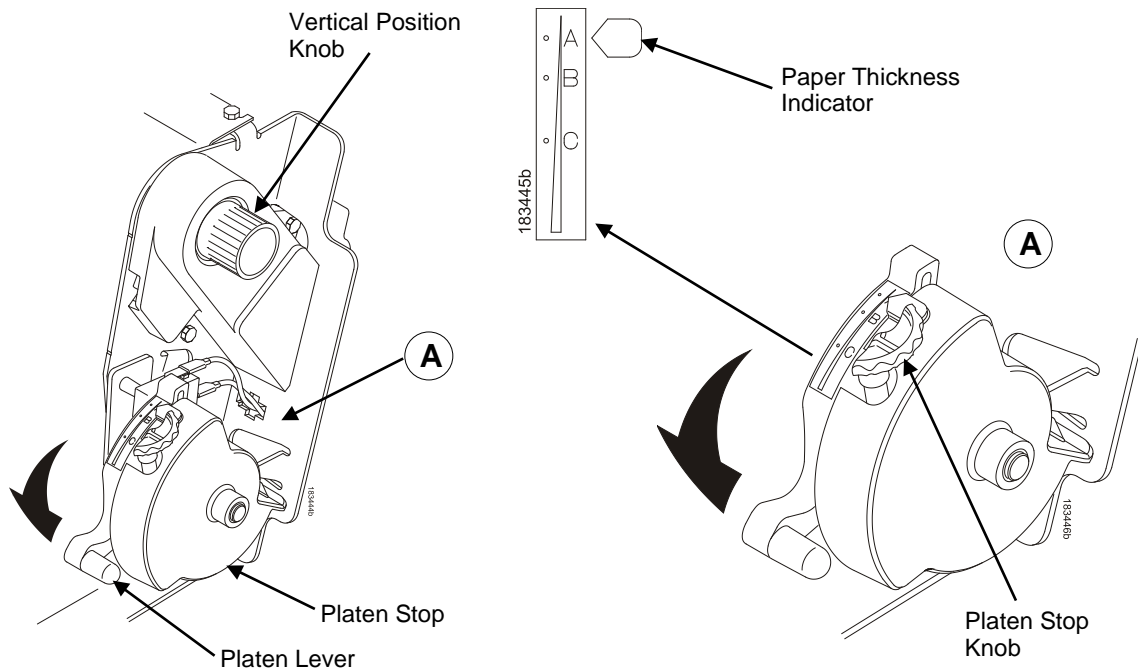

**Figure 8 Setting the Platen Lever**

9. Turn the platen stop knob clockwise or counterclockwise to match the paper thickness. (The A-B-C scale corresponds approximately to 1-, 3-, and 6-part paper thickness).

**NOTE:** If you are using the same thickness of paper, there is no need to readjust.

10. Lower the platen lever until it stops.
11. Press **ONLINE** to remove the “LOAD PAPER” fault message from the display.
12. Press **ADVANCE** several times to make sure the paper feeds properly beyond the tractors and over the lower paper guide. Feed sufficient paper to ensure the paper stacks correctly.
13. Close the printer top cover. Close the cabinet front door.
14. Press **ONLINE** to place the printer in online mode and resume printing.

**NOTE:** Perform steps 15 to 31 only if you are unable to load the new paper over the existing paper.

15. Open both tractor doors.
16. Remove the old paper from the tractors. Allow the paper to fall into the paper supply area.
17. Feed the new paper up through the paper slot. Hold the paper to prevent it from slipping down through the paper slot (see Figure 6 on page 28).

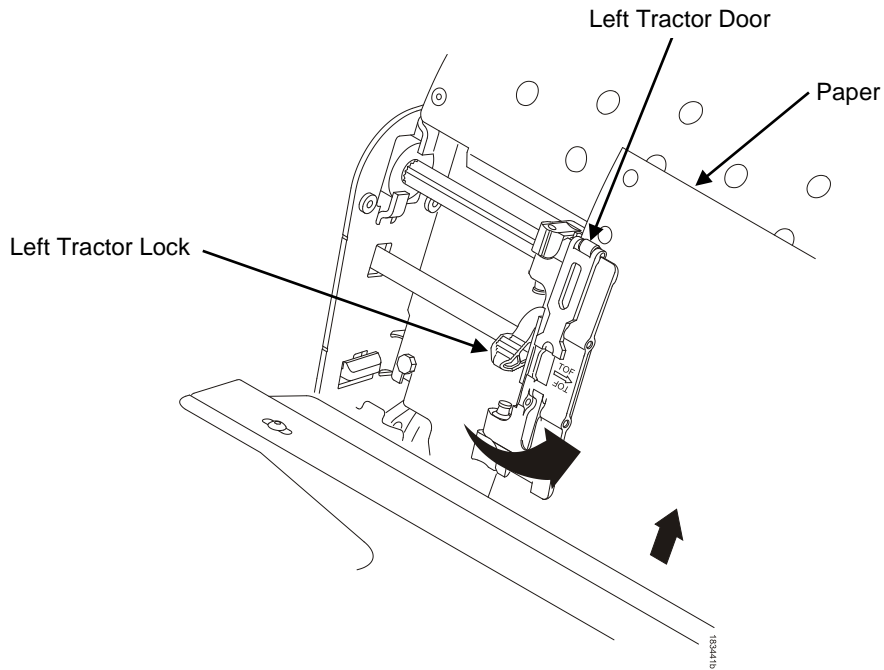

**Figure 9 Loading Paper on the Left Tractor**

18. Pull the paper above and behind the ribbon mask. See Figure 4 on page 21 for the ribbon mask location.
19. Load the paper on the left tractor.
20. Close the tractor door.

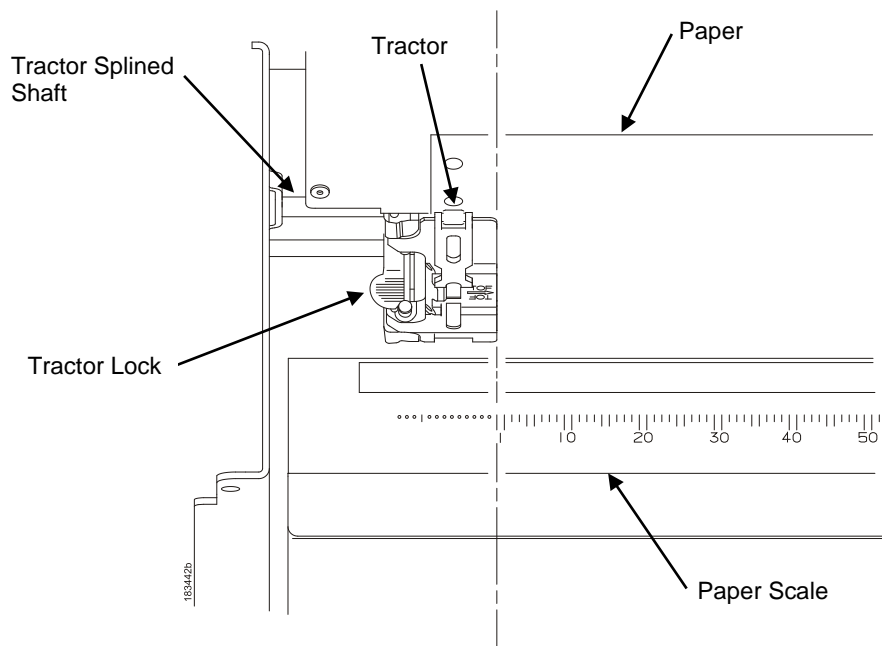

**Figure 10 Positioning the Left Tractor to Avoid Damage**

**CAUTION** To avoid damage to the printer caused by printing on the platen, always position the left tractor unit directly to the left of the “1” mark on the paper scale.

21. Normally, you should not need to adjust the position of the left tractor. If adjustment is necessary, unlock the left tractor by placing the tractor lock in the middle position. Slide the tractor until it is directly to the left of the number "1" on the paper scale and lock it. (You can also use the paper scale to count columns.)

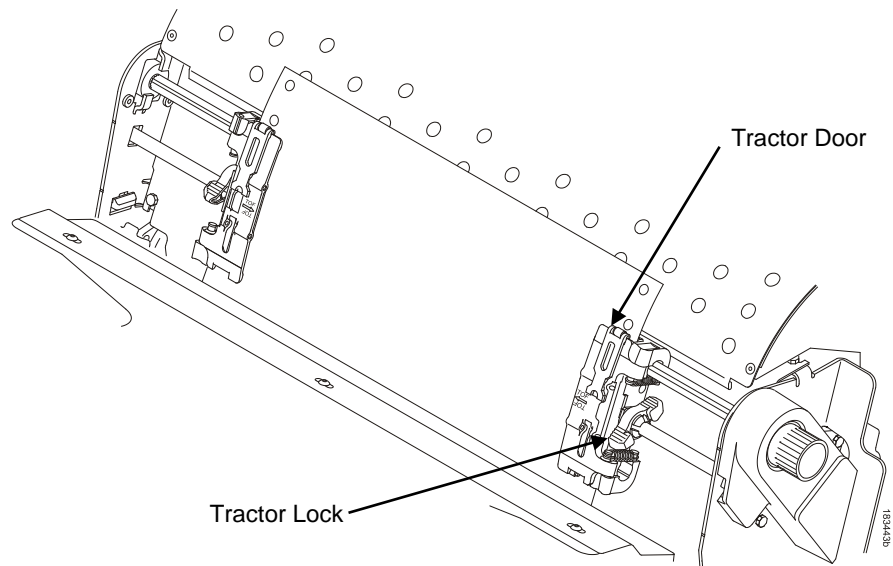

**Figure 11 Loading Paper onto the Sprockets**

22. Unlock the right tractor.
23. Load the paper onto the sprockets and close the tractor door. If necessary, slide the right tractor to remove paper slack or to adjust for various paper widths. Then, lock the tractor.



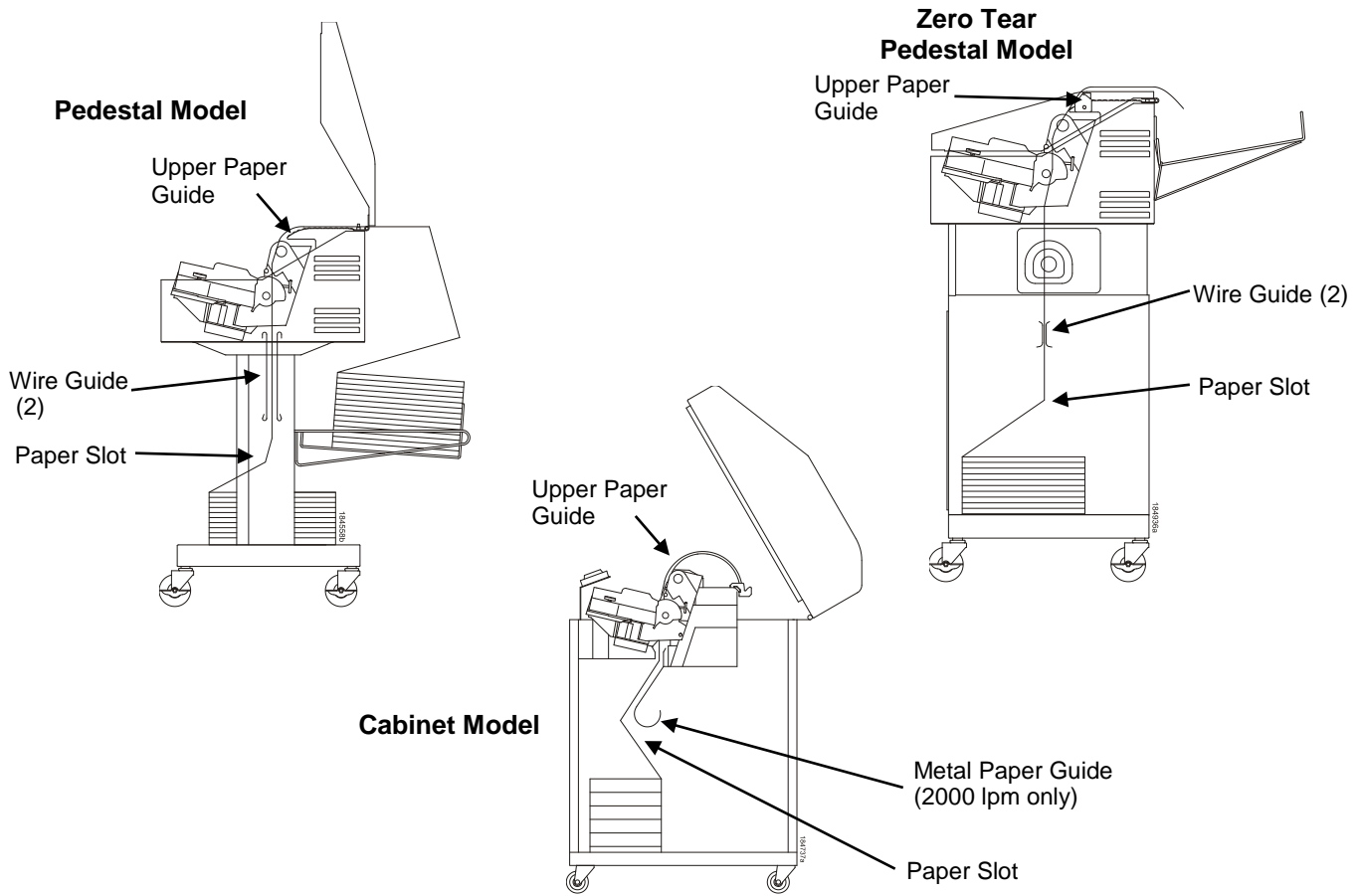

**Figure 12 Using the Paper Guide to Orient the Paper**

**24. Pedestal, or Zero Tear Pedestal models:**

Using the vertical position knob to move the paper up, guide the paper over the upper paper guide and through the slot to the rear of the top cover.

25. Press **ADVANCE** several times to make sure the paper feeds properly beyond the tractors and over the lower paper guide. Feed sufficient paper to ensure the paper stacks correctly.

**26. Cabinet models:**

Open the cabinet rear door. Make sure the paper is aligned with the label in the output area (inside the cabinet). Close the front and rear doors.

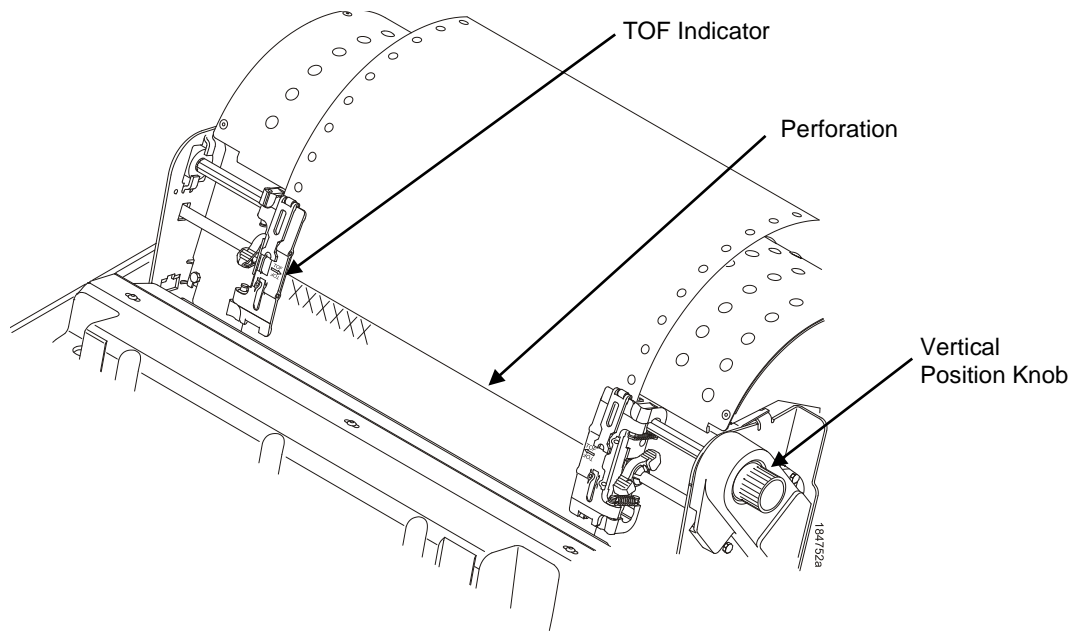

**Figure 13 Aligning the Perforation with the TOF Indicator**

27. Align the top of the first print line with the TOF indicator on the tractor by rotating the vertical position knob. For best print quality, it is recommended that the top-of-form be set at least one print line or more below the perforation.

**NOTE:** For exact positioning, press the **VIEW** key to move the last data printed to the tractor area for viewing. While in View mode “Printer in View” displays. Press the Up or Down Arrow keys to move the paper vertically in small increments. Pressing the **VIEW** key a second time moves the paper back to the adjusted print position. The key works both online and offline provided that the printer is in View mode. (This procedure is applicable for both the cabinet and pedestal models.)

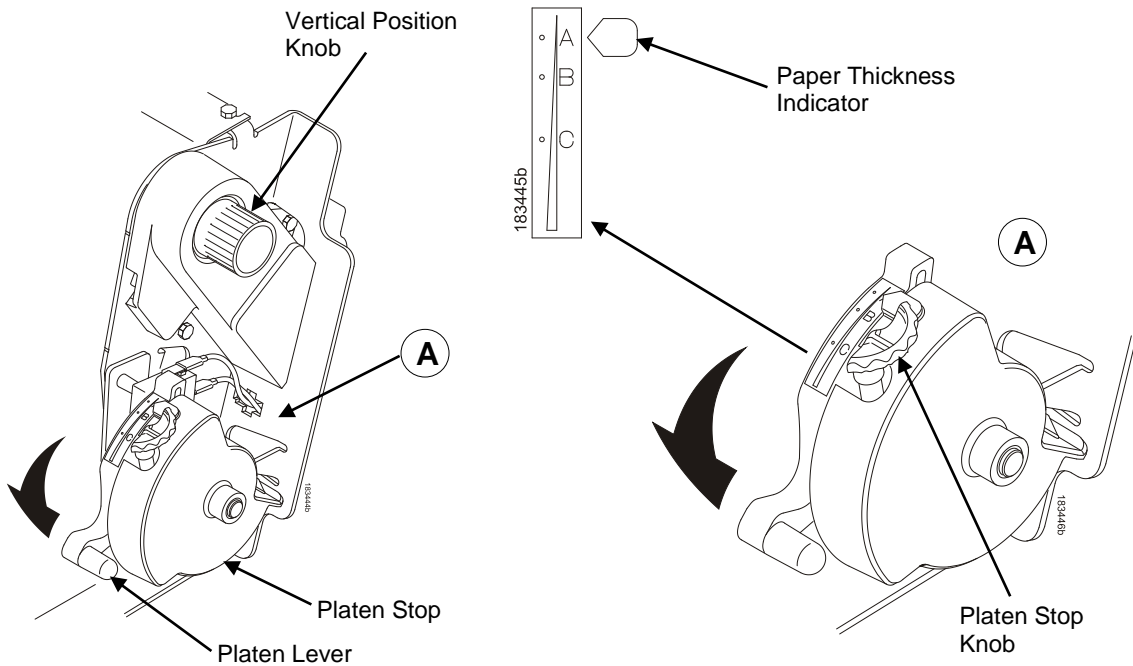

**Figure 14 Adjusting the Platen Lever**

28. Turn the platen stop knob clockwise or counterclockwise to match the paper thickness. (The A-B-C scale corresponds approximately to 1-, 3-, and 6-part paper thickness. Adjust until you have the desired print quality).

**NOTE:** The platen stop allows you to set an optimum and consistent thickness that is not affected when opening and closing the platen lever.

29. Lower the platen lever until it stops.
30. Press **ONLINE** to clear any fault messages (such as “LOAD PAPER”) from the LCD.
31. Press **TOF**. The top-of-form you have set moves down to the print position. If there is data in the buffer, the paper moves forward to the last print position on the next page.
32. Press **ONLINE** and close the printer cover.

## Unload Paper

1. Press **ONLINE** to place the printer in offline mode and open the printer cover.
2. For cabinet models, open the cabinet rear door.

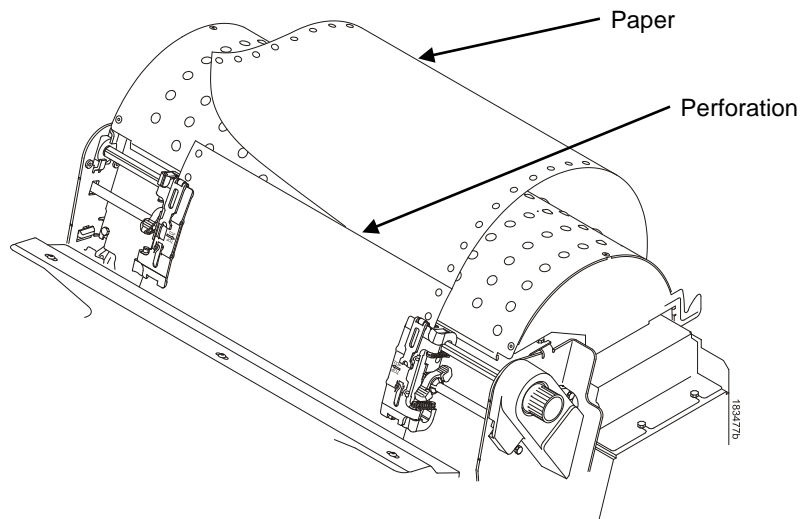

**Figure 15 Unloading the Paper from the Printer**

3. Tear off the paper at the perforation.
4. Allow the paper to fall to the back of the printer and into the paper stacking area.
5. For pedestal models, remove the stacked paper from the paper tray.
6. For cabinet models, remove the stacked paper from the rear cabinet floor.
7. Close the cabinet rear door.

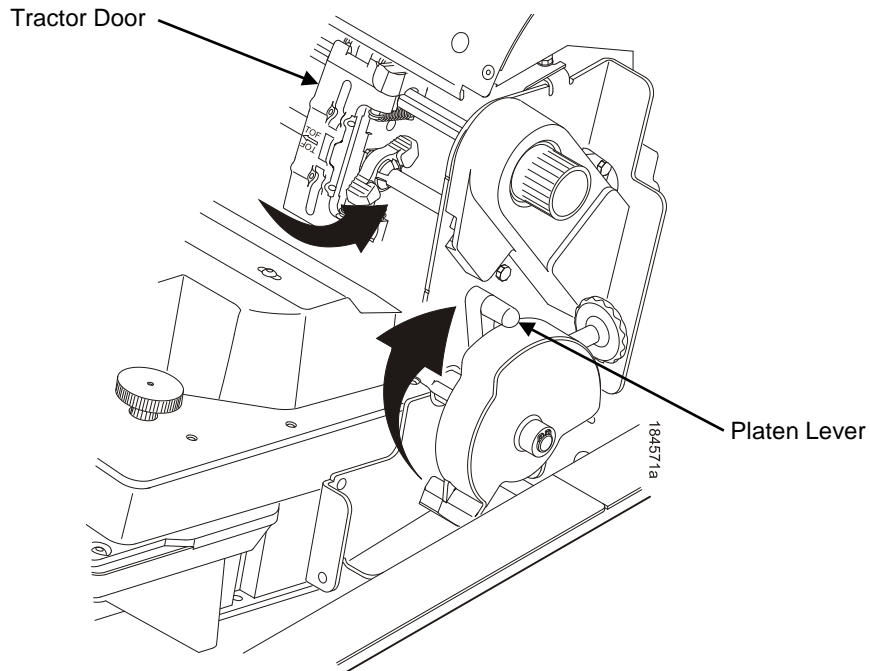

**Figure 16 Completely Removing the Paper**

8. To completely remove the paper from the printer:
  - a. Raise the platen lever as far as it will go and open both tractor doors.

**CAUTION** Be careful when pulling any paper backward through the paper path, especially when using a label stock. If you are not careful, labels can detach and adhere to the printer within the paper path, where only an authorized service representative can remove them.

- b. Open the cabinet front door.
- c. Gently pull the paper down through the paper slot. Allow the paper to fall into the paper supply area.
- d. Remove the paper from the paper supply area.

## Integrated Print Management System

The P8000 has a feature that automatically monitors and communicates the status of the ribbon life to help the operator know when to change ribbons. Using an ink delivery system called the Cartridge Ribbon System (CRS), the printer can automatically detect when a new or used ribbon is loaded, and all ribbon properties. The ribbon is contained in a plastic box (the cartridge) and feeds only in one direction. The CRS contains an interface board that allows communication between the printer and the cartridge. Using the CRS, the P8000 automatically detects when a new or used ribbon is installed and determines the ribbon's length, ink color, and expected yield. The ribbon life, starting from 100% when new and decreasing to 0% when depleted, is always displayed on the control panel. See Figure 5 on page 24.

When the ribbon life reaches 2%, a warning message "RIBBON UNDER 2%/ Change RBN soon" appears on the control panel display. The control panel status indicator lamp flashes. The printer will continue printing in this condition until the ribbon life reaches 0% at which time, printing will stop. The ribbon may be changed at any time while the printer is in the "CARTRIDGE AT END POINT/Change Cart" condition without losing data in the printer's buffer. If a new ribbon is loaded, the system automatically detects the change, clears the condition when the platen is closed, and restarts the life at 100%. If a partially used ribbon is loaded, the system continues the life at the percentage indicated for the used ribbon.

You may also resume printing for approximately two more minutes without changing the ribbon by pressing the **ONLINE** key twice. This may be done as many times as needed to complete the job in progress.

Ribbon usage information is calculated by maintaining a count of impressions (dots) that is stored on the ribbon cartridge and updated periodically so that the cartridge can be used on a different printer with the information intact. This allows the system administrator to have precise control over print quality and consumable costs. The accurate presentation of available ribbon life allows for efficient planning of print jobs. For example, if the displayed ribbon life were low, you can install a new ribbon before printing a large print job.

## Output Darkness

By default the system is configured to meet most user requirements. However, some applications require that the output remains darker than the nominal set point while some applications are less critical and could tolerate a lighter final image. The system can easily adjust to this variability. A setting under the Printer Control menu is available that allows the user to adjust the final output. The range is as follows:

Normal (Default)  
Darker +1 through +6  
Lighter -1 through -10

The ribbon life indicator always cycles between 100% and 0%, but if a darker setting is selected, zero will be reached more quickly. If a lighter setting is selected, the system will extend the amount of printing it takes to reach zero.

## Loading a Used Ribbon Cartridge

You can take the ribbon cartridge off the printer and reload it at a later time. The ribbon life gauge automatically updates to reflect the correct remaining capacity.

**NOTE:** Since the ribbon usage information is stored on the ribbon cartridge, you can reload a partially used cartridge onto a different printer.

## Lighter or Darker Print

The ribbon life value as determined by the Integrated Print Management System is factory set so that the image quality at the end of the ribbon life is as good as it was when the ribbon was new. You may adjust the ribbon end point for a lighter or darker image as required for your printing needs. See **PRINTER CONTROL** Menu on page 190.

## Changing Ribbon Cartridge

Before changing the ribbon cartridge, determine whether at the end of ribbon life if you want to make the print lighter (extend the ribbon life) or darker (shorten the ribbon life). If you want to make the print lighter or darker, go to Ribbon End Point on page 75 and follow the procedures for adjusting the image density. If you are satisfied with the print darkness, continue with the following steps.

**NOTE:** Ribbon cartridge instructions and illustrations shown in the following section are for the pedestal model. Follow the same procedures for the cabinet model.

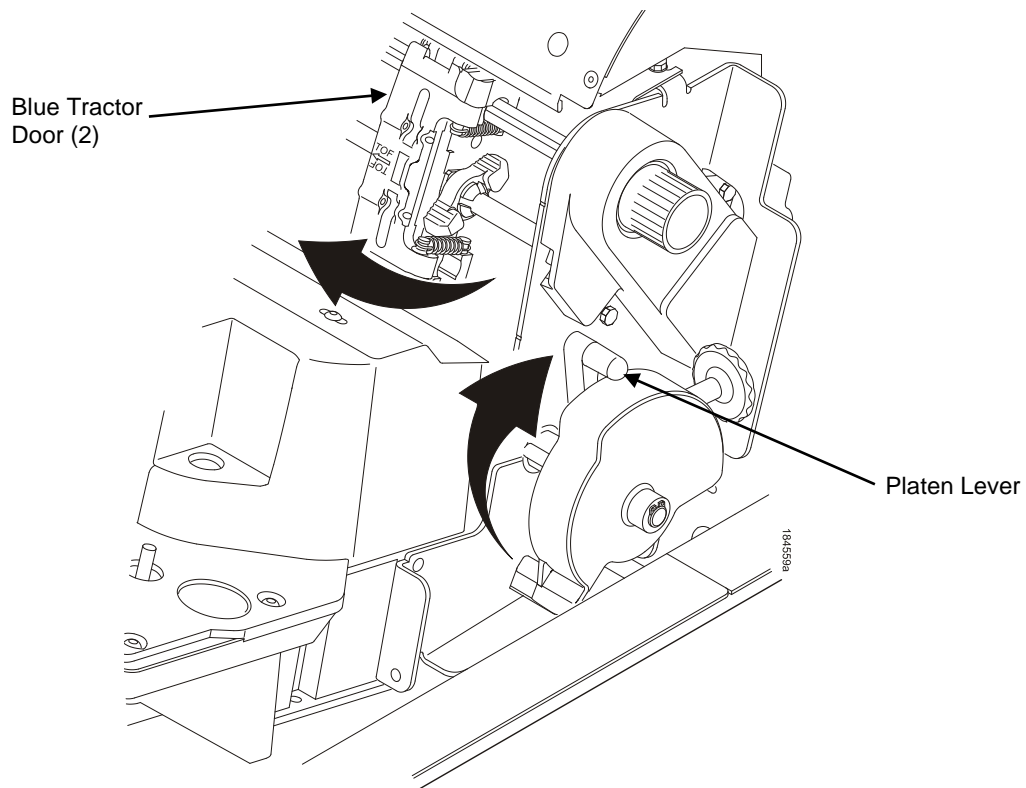

**Figure 17 Preparing to Load the Ribbon**

1. Open the printer cover.
2. Raise the platen lever as far as it will go.
3. Close the tractor doors.
4. Remove the old ribbon cartridge and discard properly.

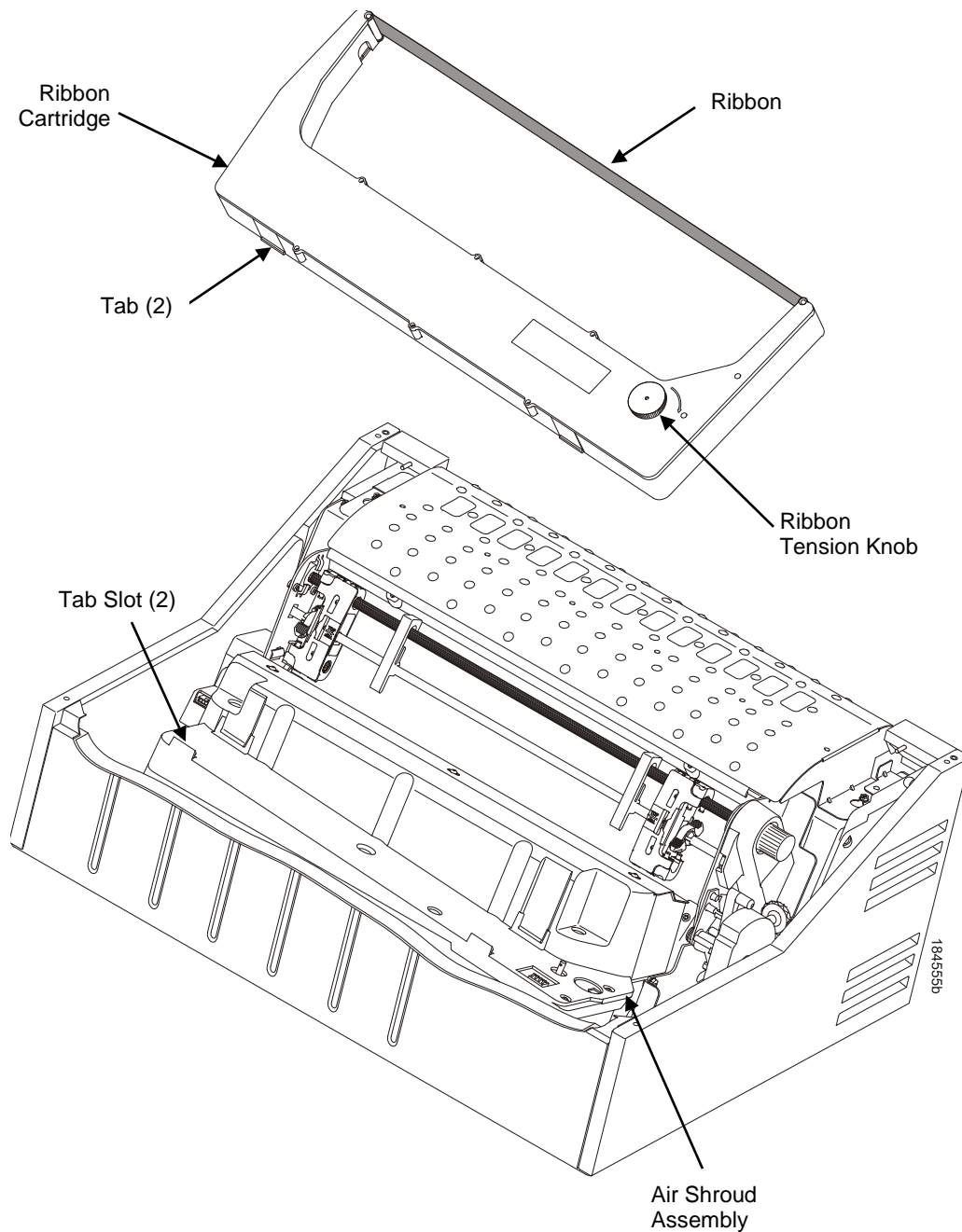
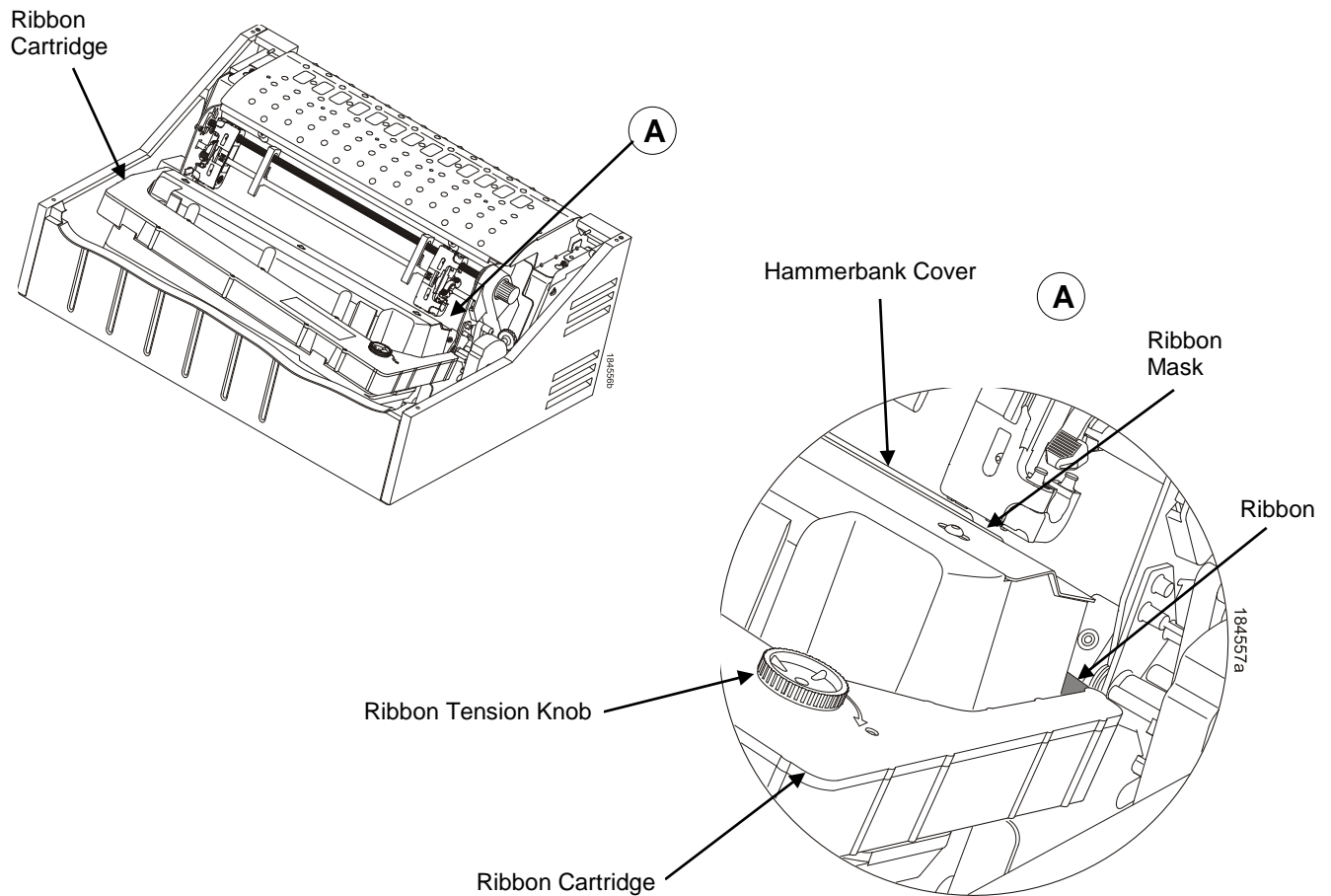

**Figure 18 Installing the Ribbon Cartridge**

5. Remove the ribbon slack on the new ribbon cartridge by turning the ribbon tension knob clockwise.

**CAUTION** Do not turn the ribbon tension knob counterclockwise. This could damage the ribbon cartridge.

6. Hold the cartridge at an angle, so that the rear side nearest you is lower than the side with the ribbon. Find the two tabs on the outside of the cartridge and place them into the corresponding slots on the air shroud assembly (see Figure 18).



**Figure 19 The Ribbon Cartridge Snapped in Place**

7. Rock the cartridge downward, making sure that the ribbon goes between the guide and the mask (see Figure 19). You will feel it snap into place.

**CAUTION** Make sure that the ribbon does not twist or fold over.

8. Turn the ribbon tension knob clockwise a few times to make sure the ribbon tracks correctly in the ribbon path.
9. Close the platen lever.
10. Close the printer top cover.
11. Press the **ONLINE** key twice to return the printer to operation.



# 4 *The Configuration Menus*

## Configuration Overview

To print data, the printer must respond correctly to signals and commands received from the host computer. Configuration is the process of matching the printer's operating characteristics to those of the host computer and to specific tasks, such as printing labels or printing on different sizes of paper. The characteristics which define the printer's response to signals and commands received from the host computer are called configuration parameters.

You can configure the printer using the configuration menus and the control panel or by sending control codes in the data stream from a host computer attached to the printer. This chapter provides an introduction to configuring the printer and includes the configuration menus available (depending on which emulation you have installed in the printer).

**IMPORTANT** Configuration directly affects printer operation. Do not change the configuration of your printer until you are thoroughly familiar with the procedures in this chapter.

### First Power On

ASCII firmware from the factory has the IPDS/PGL/VGL/LP+, TN 3270/5250, PCL-II, and ANSI program files loaded. We refer to this as the ASCII bundle firmware. If you have the ASCII bundle firmware installed, you will be prompted to choose the active program on the first power up. Once a selection for the active program has been made you will not be prompted to make this choice again. You will have the opportunity at any time to change the active program from the "Program Select" menu as described in the following sections. Selection of an active program could take three to five minutes and require rebooting the printer.

### Main Menu

The Main Menu is organized based on the following firmware types:

1. P8000 Standard Firmware (IPDS/PGL/VGL/LP+)
2. P8000 TN Firmware (TN/PGL/VGL/LP+)
3. P8000 PCL-II Firmware (PCL-II/PGL/VGL/LP+)
4. P8000 LG Firmware (LG/PGL/VGL/LP+)
5. P8000 ANSI Firmware (ANSI/PGL/VGL/LP+)
6. OpenPrint P8000 Standard Postscript/PDF Firmware (PS/PGL/VGL/LP+)
7. OpenPrint P8000 HD Postscript/PDF Firmware (PS)
8. H-Series Firmware (LP+)
9. Indian Language Firmware (LP+)
10. Arabic Language Firmware (LP+/ANALYZER)

### Changing Parameter Settings

You may change a printer parameter setting, such as line spacing or forms length, either by pressing keys on the control panel or by sending emulation control codes in the data stream from a host attached

to the printer. The control panel allows you to configure the printer's resident set of configuration menus. An example procedure for using the control panel to change parameter settings begins on page 46.

When control codes are sent from a host attached to the printer, they override control panel settings. For example, if you set the line spacing to 6 lpi with the control panel, and application software later changes this to 8 lpi with a control code, the control code overrides the control panel setting.

## Saving Parameter Settings

The parameter settings that you have changed can be permanently stored in the printer's memory as a configuration. See Auto Save Configuration on page 49 and Saving Your New Configuration on page 49.

You may also save your new configurations using the PTX\_SETUP command host control code. See your *IGP/PGL Programmer's Reference Manual* for details.

## Default and Custom Configurations

A configuration consists of a group of parameter settings, such as line spacing, forms length, etc. Your printer provides a fixed default configuration and allows you to define several custom configurations for use with particular print jobs. The factory default configuration can be loaded, but it cannot be altered.

Eight configurations can be modified for unique print job requirements. The "Save Config." option allows you to save eight groups of parameter settings in memory as custom configurations numbered from 1 through 8. An explanation on how to save a set of parameter values as a custom configuration using the "Save Config." menu option begins on page 49.

## Navigating the Menus

To manipulate configurations review the following instructions about navigating through the menus.

You must be Menu mode to navigate the menus.

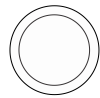

ONLINE

Press to toggle between ONLINE and OFFLINE. Press **ENTER** to enter Menu mode. Menus are accessed only in Menu mode.

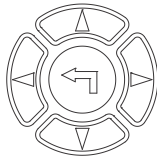

Scroll up, down, left, or right through the icons to highlight the area of interest.

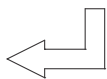

Press to enter the area of interest. This will take you into that section and list three menu selections, with the middle selection highlighted.

**NOTE:** For display languages in Korean, Simplified Chinese, or Traditional Chinese, only one menu selection is shown at a time.

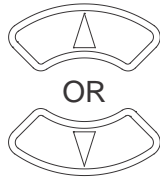

Press to move up or down through the menu selections. The highlighted menu is the active selection.

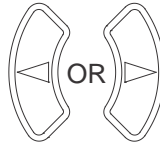

Press to scroll through the available choices for the highlighted menu. If the highlighted menu contains submenus, these buttons have no effect and the message “↵ for Submenu” will display.

ENTER



Press to confirm selection. For normal menus, this will change or execute the menu. If the selection has submenus, the submenu will be entered.

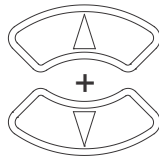

Press to lock and unlock the ENTER key. The ENTER key is locked by default to prevent you from accidentally changing the printer configuration. The lock and unlock function can be configured to be other than  $\triangle + \nabla$  (See Set Lock Key on page 205.)

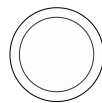

CANCEL

Press to return to the previous menu level.

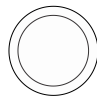

ONLINE

Press to return to Offline mode. If changes were made, the user will be prompted to save or discard the configuration.

To experiment with navigating the menus, use the example on the next page as a tutorial.

## Top Level Menu Overview

When entering Menu mode, the user will see top level menu represented as icons as shown below. Use the navigation buttons up, down, right, and left to highlight the desired icon. As the user navigates, the name of the top level menu displays on the top line of the LCD.



Table 3 provides brief descriptions of first level configuration menu options:

**Table 3 Icon Level Menus**

Menu Icon	Menu	Description
	QUICK SETUP	These options allow quick access to the most frequently changed or inputted parameters during the installation of the printer.
	PRINTER CONTROL	This menu allows you to select parameters common to a general user, such as display language and Barcode quality.
	ADVANCED USER	This menu allows you to select several advanced operating parameters for the printer, such as the speed at which paper will advance when slewing. The <b>SURE SCAN</b> menu for OpenPrint models is under this menu.
	CONFIG. CONTROL	These options allow you to save, print, load, delete, name, and reset entire sets of configuration parameters.
	HOST INTERFACE	These options allow you to select either the Serial RS-232, Centronics® parallel, Ethernet™, IEEE® 1284 parallel, or Auto Switching interface for the printer. This menu also allows you to configure several parameters for each interface.
	NETWORK SETUP	This option allows you to select from Ethernet Address options and Ethernet Parameters options.
	EMULATION	This menu allows you to configure the options which are available for the current operating (active) emulation. For example, if LinePrinter+ is the active emulation, then the LinePrinter+ emulation options can be configured using this menu. The <b>ACTIVE IGP EMUL</b> and <b>ACTIVE EMULATION</b> menus are under this menu.
	DIAGNOSTICS	This menu includes the diagnostic tests, system memory, software build part number, Feature File (if one exists), the shuttle type, and statistics of the printer. The <b>Printer Mgmt</b> menu is under this menu.





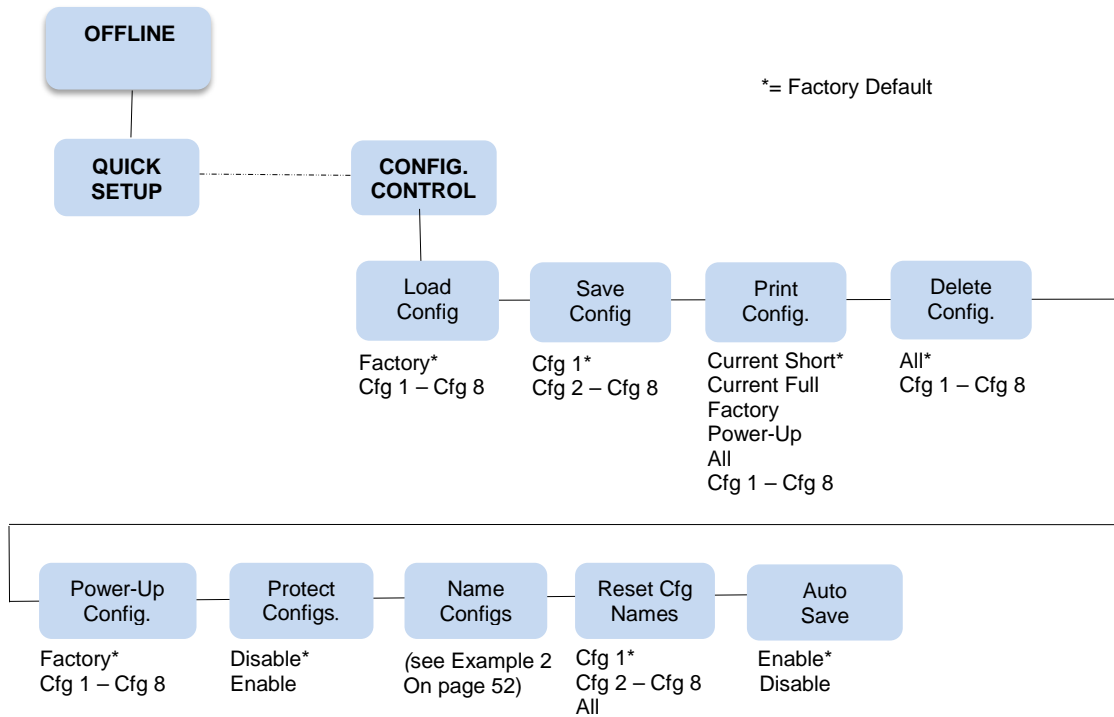





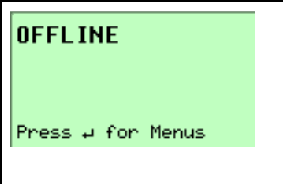

## Changing Parameters Example

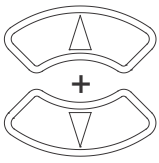
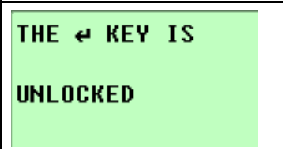



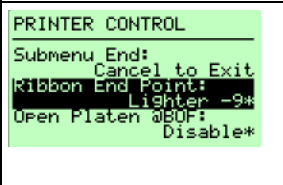

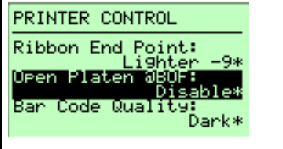
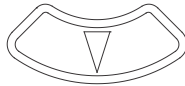



A configuration consists of several parameters. The default factory configuration has a starting set of parameters. In the configuration menu above, and in all the configuration menus in this chapter, the factory default values are indicated by an asterisk (\*).

Your print jobs may require parameter values which vary from the default settings. This section provides an example procedure for changing individual parameter values.

The following procedure shows how to change and save the settings for the Barcode Quality and Panel Display options. Use these guidelines to navigate the configuration menus and change other parameters.

Step	Press	LCD	Notes
1.	Make sure the printer is on.		
2.	 ONLINE		
3.	ENTER 		Shows the top level icons.
4.			Allows you to make configuration changes.
			
5.	 UNTIL		
6.	ENTER 		
7.			
8.	 UNTIL		

Step	Press	LCD	Notes
9.	 UNTIL	<pre> PRINTER CONTROL Open Platen @BOF:   Disable* Bar Code Quality:   Draft* Tear Bar Dist.:   13.98 inches* </pre>	The * indicates this choice is active.
10.	ENTER 	<pre> PRINTER CONTROL Open Platen @BOF:   Disable* Bar Code Quality:   Draft* Tear Bar Dist.:   13.98 inches* </pre>	
11.	 UNTIL	<pre> PRINTER CONTROL Display Language:   English* Panel Display:   Ribbon Life* Accented Chars.:   Standard* </pre>	
12.	 UNTIL	<pre> PRINTER CONTROL Display Language:   English* Panel Display:   IP Address* Accented Chars.:   Standard* </pre>	The * indicates this choice is active.
13.	ENTER 	<pre> PRINTER CONTROL Display Language:   English* Panel Display:   IP Address* Accented Chars.:   Standard* </pre>	
14.	 + 	<pre> THE ← KEY IS LOCKED </pre>	Locks the ENTER key.
15.	 ONLINE	<pre> OFFLINE  Press ↓ for Menu </pre>	Press ENTER to go back into the menus or press ONLINE again to go ONLINE.
16.	 ONLINE	<pre> Menu Changes Detected Save Permanently Save Temporarily Cancel Changes Restore Factory Press ↓ to Select </pre>	Configuration changes were detected and you are prompted to save the configuration permanently or temporarily, to cancel changes, or restore the Factory Configuration.

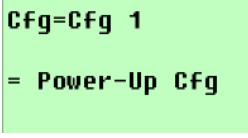
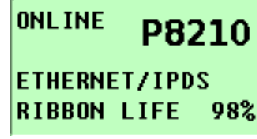

Step	Press	LCD	Notes
17A.	ENTER 		Saves the Configuration as Config 1 then returns the printer ONLINE.
17B.			Places the printer online after permanently saving the configuration changes as Config 1.
18.	The printer is ready for operation		

## Auto Save Configuration

If the user makes a menu change and attempts to place the printer online without saving the changes to a configuration, the following prompt displays:

```
Menu Changes Detected
Save Permanently
Save Temporarily
Cancel Changes
Restore Factory
Press ↵ to Select
```

The active option is highlighted. Use the Up and Down keys to scroll through the different options; the keys will loop at the top and bottom options. The ↵ (Enter) key selects the highlighted option. After performing the selected option, the printer will go to Online mode.

**NOTE:** Only the Up, Down, and Enter keys work at the Menu Changes Detected prompt.

- **Save Permanently** (factory default). This option causes the printer to save the configuration to the active configuration and make the active configuration the Power-Up default configuration. If the active configuration is the Factory Configuration, the printer will save the configuration to an open configuration and make that open configuration the Power-Up default configuration.

If no open configuration is available, the user must decide which configuration to overwrite. In this case the printer will display the Save Configuration menu, otherwise, the printer will go Online.

- **Save Temporarily.** Menu changes will be implemented, but will not be saved once the printer is powered off.
- **Cancel Changes.** This option causes the printer to reload the Active Configuration, then go Online.
- **Restore Factory.** This option will cause the printer to reload the Factory Configuration, then go Online.

**NOTE:** A printer fault during the Auto Save process causes the printer to Save Temporarily.

## Saving Your New Configuration

The Save Config. option allows you to save up to eight custom configurations to meet different print job requirements. Once you have changed all of the necessary parameters, you may save them as a numbered configuration (Example 1 on page 50) or a named configuration (Example 2 on page 52) that





can be stored and loaded later for future use. If you do not save your configuration using the Auto Save, or this option, all of your parameter changes will be erased when you power off the printer.





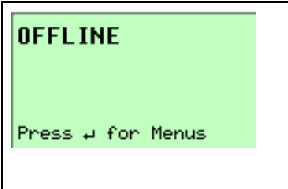

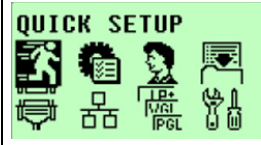
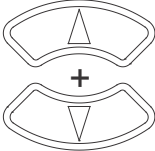
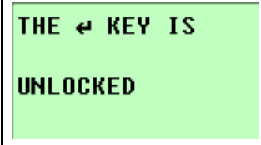
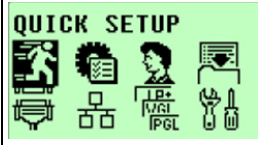

Once you have saved a custom configuration using this option, it will not be lost if you power off the printer. You can load a configuration for a specific print job (see Load Config. on page 76). You can also modify and resave it. You may want to print your configurations (see Print Config. on page 76) and store them in a safe place, such as inside the printer cabinet. If the Protect Configs. parameter is enabled and you try to resave an existing configuration, the new configuration will not be saved until the existing configuration has been deleted (see Delete Config. on page 76).



**NOTE:** Once you change active emulations, any changes to the previously selected emulation will be gone unless they have been saved.

### Example 1

This example shows how to save a configuration as a numbered configuration, then later print it.





Step	Press	LCD	Notes
1.	Make sure the printer is on.		
2.	 ONLINE		
3.	ENTER 		
4.			Allows you to make configuration changes.
			
5.	 UNTIL		









Step	Press	LCD	Notes
6.	ENTER 	<pre> CONFIG. CONTROL ----- Submenu End: Cancel to Exit Load Conf19.: Cfg 1* Save Conf19.: Cfg 1* </pre>	
7.		<pre> CONFIG. CONTROL ----- Load Conf19.: Cfg 1* Save Conf19.: Cfg 1* Print Conf19.: Current Short* </pre>	
8.	 UNTIL	<pre> CONFIG. CONTROL ----- Load Conf19.: Cfg 1* Save Conf19.: Cfg 2 Print Conf19.: Current Short* </pre>	
9.	ENTER 	<pre> CONFIG. CONTROL ----- Load Conf19.: Cfg 1* Save Conf19.: Cfg 2* Print Conf19.: Current Short* </pre>	The * indicates this choice is active.
<b>NOTE:</b> We recommend that you print the configuration. To print the configuration go to Step 10. To skip this procedure and resume printer operation, go to Step 13.			
10.		<pre> CONFIG. CONTROL ----- Save Conf19.: Cfg 2* Print Conf19.: Current Short* Delete Conf19.: All* </pre>	
11.	 UNTIL	<pre> CONFIG. CONTROL ----- Save Conf19.: Cfg 2* Print Conf19.: Cfg 2 Delete Conf19.: All* </pre>	
12.	ENTER 	<pre> CONFIG. CONTROL ----- Save Conf19.: Cfg 2* Print Conf19.: Cfg 2* Delete Conf19.: All* </pre>	
13.	 + 	<pre> THE ← KEY IS LOCKED </pre>	Locks the ENTER key.

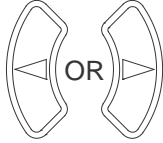

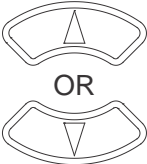
Step	Press	LCD	Notes
14.	 ONLINE	<b>OFFLINE</b>  Press ↵ for Menu	Press ENTER to go back into the menus or press ONLINE again to go ONLINE.  Places the printer ONLINE.
15.	 ONLINE	<b>ONLINE P8210</b> <b>ETHERNET/IPDS</b> <b>RIBBON LIFE 98%</b>	
16.	If you printed the configuration, store it in a safe place. The printer is ready for operation.		

### Example 2

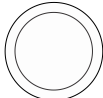
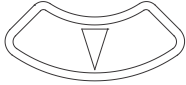
This example shows how to save a configuration as a named configuration.

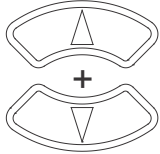
Step	Press	LCD	Notes
1.	Make sure the printer is on.		
2.	Follow Steps 2-6 from Example 1 (page 50)		
3.	 UNTIL	<b>CONFIG. CONTROL</b> Protect Configs.: Disable* Name Configs: ↵ for Submenu Reset Cfg Names: Cfg 1*	
4.	ENTER 	Name Configs Submenu End: Cancel to Exit Name Config 1: ↵ for Submenu Name Config 2: ↵ for Submenu	
5.	 UNTIL	Name Configs Name Config 1: ↵ for Submenu Name Config 2: ↵ for Submenu Name Config 3: ↵ for Submenu	
6.	ENTER 	Name Config 2 Cfg 2 Cfg 2  Press ⓧ Keys to Edit ↵ to Save&Exit Cancel to Exit	

Step	Press	LCD	Notes
7.		<pre>Name Config 2 ----- Cfg 2 <u>C</u>fg 2 Press  Keys to Edit ↓ to Save&amp;Exit Cancel to Exit</pre>	Press the left or right key to choose the character that is highlighted.
8.		<pre>Name Config 2 ----- Cfg 2 TEST<u>T</u> Press  Keys to Edit ↓ to Save&amp;Exit Cancel to Exit</pre>	Press the up key to select the next character in the string. Press the down key to go back to the previous character and continue editing as necessary.
9.	ENTER 	<pre>Name Config 2 ----- Cfg 2 TEST Press  Keys to Edit ↓ to Save&amp;Exit Cancel to Exit</pre>	Configuration 2 is renamed TEST.
10.	 CANCEL	<pre>CONFIG. CONTROL ----- Protect Configs.: Disable* Name Configs.: ↓ for Submenu Reset Cfg Names: Cfg 1*</pre>	
11.	 UNTIL	<pre>CONFIG. CONTROL ----- Load Config.: Cfg 1* Save Config.: Cfg 1* Print Config.: Current Short*</pre>	
12.	 UNTIL	<pre>CONFIG. CONTROL ----- Load Config.: Cfg 1* Save Config.: TEST Print Config.: Current Short*</pre>	
13.	ENTER 	<pre>CONFIG. CONTROL ----- Load Config.: Cfg 1* Save Config.: TEST* Print Config.: Current Short*</pre>	Your configuration is saved as TEST.
14.		<pre>THE ← KEY IS LOCKED</pre>	Locks the ENTER key.

Step	Press	LCD	Notes
15.	 ONLINE	<b>OFFLINE</b>  Press ↵ for Menu	Press ENTER to go back into the menus or press ONLINE again to go ONLINE.
16.	 ONLINE	<b>ONLINE P8210</b> <b>ETHERNET/IPDS</b> <b>RIBBON LIFE 98%</b>	Places the printer ONLINE.

Now you have the saved configuration for later use if needed.

## Optimizing Print Quality

### LP+, IGP/PGL, and IGP/VGL Emulations

You can optimize print quality for darker and sharper barcodes and characters. Doing so, however, will decrease the printer speed.

To optimize print quality, you can change the values of the following configuration parameters:

- **Bar Code Quality (Printer Control menu):** Select “Dark” or “Draft.” Dark prints the darkest images, but at the slowest speed. Draft prints at a faster speed than Dark, but the characters are not as dark. (See page 191 for a written description of Bar Code Quality.)
- **Print Quality (IGP/PGL emulation):** Select “Best” or “High.” Best prints the darkest images, but at the slowest speed. High prints at a faster speed than Best, but the characters are not as dark. (See page 147 for the IGP/PGL Configuration Menu, and page 153 for a written description of Print Quality.)
- **Print Quality (IGP/VGL emulation):** Select “High.” (See page 157 for the IGP/VGL Configuration Menu, and page 160 for a written description of Print Quality.)

### OpenPrint Postscript/PDF Emulations

You can optimize print quality for darker and sharper text and barcodes by using the following configuration parameters:

- **Unidirectional (Printer Control menu):** Select “Enable” for best quality but reduced throughput (half speed).
- **Resolution (Postscript/PDF menu):** Select higher values (horizontal by vertical DPI) to get better print quality.

### H-Series Emulations

Print quality varies based on the typeface selected. Both text and barcodes will print using the resolution of the selected typeface.

## Optimizing Print Speed

### LP+, IGP/PGL, and IGP/VGL Emulations

The printer has been configured at the factory for optimal print speed. To optimize print quality instead, you can change values for specific configuration parameters such as Barcode Quality and Print Quality. Doing so, however, will decrease the printer speed.

If you have optimized the printer for print quality, you can change it to optimize the speed by selecting the values as follows:

- **Bar Code Quality (Printer Control menu):** Select Draft.  
(See page 190 for the PRINTER CONTROL Menu, and see page 191 for a written description of Bar Code Quality.)
- **Print Quality (IGP/PGL emulation):** Select Dataprocessing.  
(See page 147 for the IGP/PGL Configuration Menu, and see page 153 for a written description of Print Quality.)
- **Print Quality (IGP/VGL emulation):** Select Dataprocessing.  
(See page 157 for the IGP/VGL Configuration Menu, and see page 160 for a written description of Print Quality.)

### OpenPrint Postscript/PDF Emulations

The printer has been configured at the Factory for optimal print quality through the Resolution configuration parameter (Postscript/PDF menu). However, users can reduce the horizontal, vertical, or both DPI values of this menu to increase printer speed. The downside of using a lower DPI value is as follows:

- Print quality is reduced and it can be difficult to read small characters.
- Barcodes may not get detected and optimized (barcodes are not searched for DPI values less than 120).

Users are encouraged to use the Resolution menu to find the right combination of Print Quality, Barcode Optimization, and Print Speed.

### H-Series Emulations

The print speed varies based on the typeface selected.

## Dynamic Menu Options

The main menus for each of the different firmware types have several footnotes based on the possible options installed with the printer. This includes HOST IO connectivity, various hardware/mechanical options, and software emulations and features. The P8000 products dynamically detect options installed and only include relevant menus for the user to configure. The following is a description of the types of installation options and their effect on the main menu:

- **HOST INTERFACE:** Ethernet related menus are only present when the hardware is installed/enabled.
- **NETWORK SETUP:** The NETWORK SETUP menu is only present when Ethernet is installed.
- **Centronics and IEEE 1284:** Options are only selectable or configurable when the optional parallel interface card is present.
- **QUICK SETUP:** This menu is a collection of popular menus to help users quickly configure the printer. It is also affected by the installed options.

# Active Emulations

The emulations present in the printer are based on the firmware installed and the emulation options included. Both are configured from the Factory and do not require any action from the user.

**IMPORTANT** Be sure to know which type of firmware and options are purchased (see Table 4) to understand the ACTIVE IGP EMUL, ACTIVE EMULATION, and EMULATION main menus. H-Series and Indian Language products only have the LinePrinter+ emulation.

**Table 4 Available Firmware Types and Options**

Firmware Type	Optional Emulations Available	ACTIVE IGP EMUL <sup>1</sup>	ACTIVE EMULATION <sup>2</sup>	EMULATION <sup>3</sup>
<b>P8000 Standard</b>	IPDS PGL/VGL	IGP/PGL*	N/A	IPDS IGP/PGL LinePrinter+
		IGP/VGL	N/A	IPDS IGP/VGL LinePrinter+
<b>P8000 TN</b>	PGL/VGL	IGP/PGL*	N/A	IGP/PGL LinePrinter+
		IGP/VGL	N/A	IGP/VGL LinePrinter+
<b>P8000 PCL-II</b>	PGL/VGL	N/A	PCL-II*	PCL-II
			IGP/PGL & LP+	IGP/PGL LinePrinter+
			IGP/VGL & LP+	IGP/VGL LinePrinter+
<b>P8000 LG</b>	PGL/VGL	N/A	LG*	LG
			IGP/PGL & LP+	IGP/PGL LinePrinter+
			IGP/VGL & LP+	IGP/VGL LinePrinter+
<b>P8000 ANSI</b>	PGL/VGL	N/A	44/48XX-ANSI*	44/48XX-ANSI
			IGP/PGL & LP+	IGP/PGL LinePrinter+
			IGP/VGL & LP+	IGP/VGL LinePrinter+



**Table 4 Available Firmware Types and Options**

<b>Firmware Type</b>	<b>Optional Emulations Available</b>	<b>ACTIVE IGP EMUL <sup>1</sup></b>	<b>ACTIVE EMULATION <sup>2</sup></b>	<b>EMULATION <sup>3</sup></b>
<b>OpenPrint P8000 Standard <sup>4</sup></b>	PGL/VGL	N/A	Postscript / PDF*	Postscript/PDF
			IGP/PGL & LP+	IGP/PGL LinePrinter+
			IGP/VGL & LP+	IGP/VGL LinePrinter+
<b>OpenPrint P8000 HD <sup>4</sup></b>	N/A	N/A	N/A	Postscript/PDF
<b>H-Series</b>	N/A	NA	N/A	LinePrinter+
<b>Indian Language</b>	N/A	NA	N/A	LinePrinter+
<b>Arabic Language</b>	N/A	N/A	N/A	LinePrinter+ ANALYZER
<p><b>NOTE:</b></p> <p>* = Default Selection</p> <p><sup>1</sup> The Active IGP EMULATION menu is only available when the PGL/VGL option is installed.</p> <p><sup>2</sup> The ACTIVE EMULATION menu shows the options "IGP/PGL &amp; LP+" and "IGP/VGL &amp; LP+" when the PGL/VGL option is installed. Otherwise, "LinePrinter+" replaces the options.</p> <p><sup>3</sup> The selections under the EMULATION menu is based on the ACTIVE IGP EMULATION or ACTIVE EMULATION settings with all Optional Emulations installed.</p> <p><sup>4</sup> The Postscript emulation cannot process color documents. All documents sent to the OpenPrint printer must be either gray scale or black and white.</p>				

## P8000 Standard Firmware

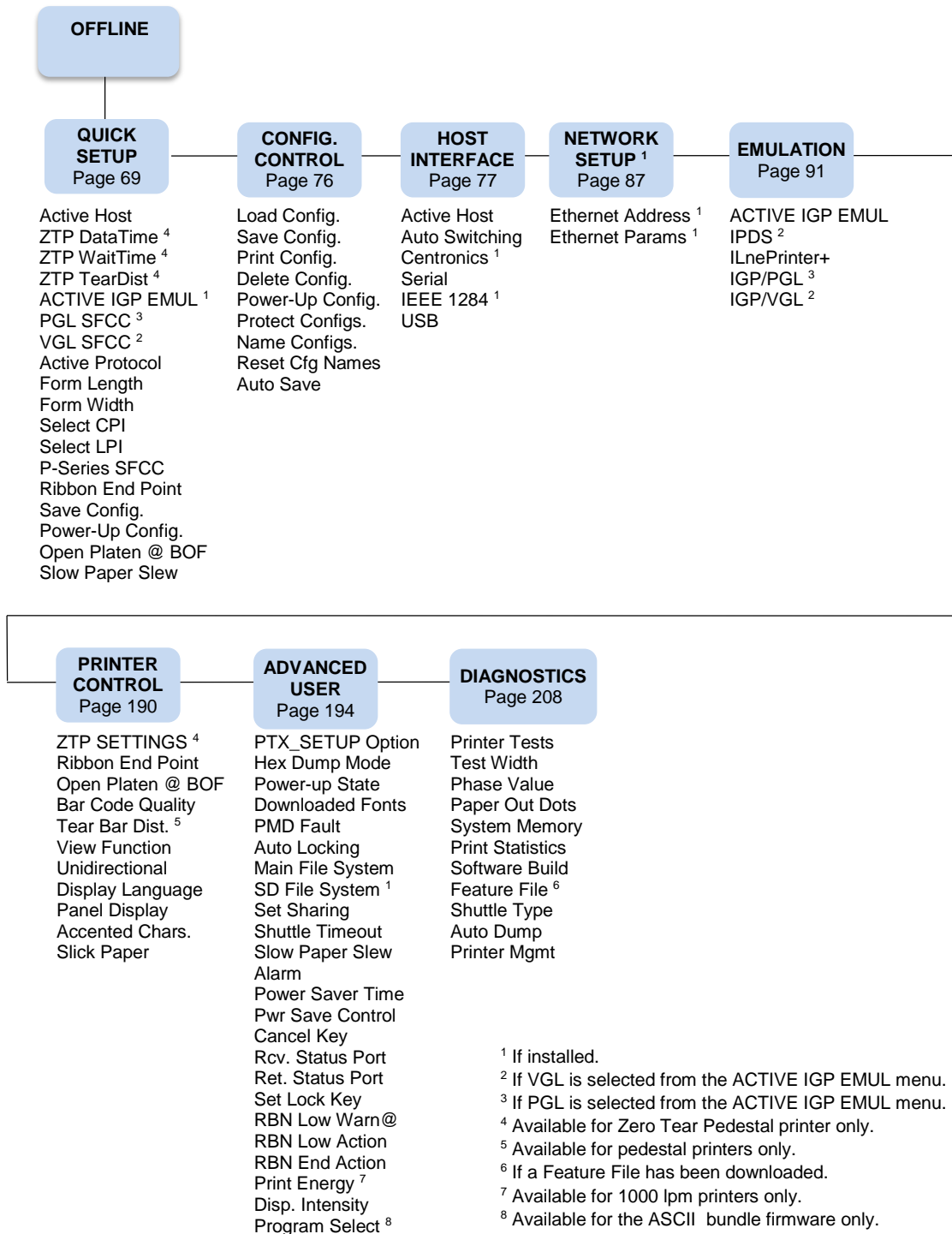

# P8000 TN Firmware

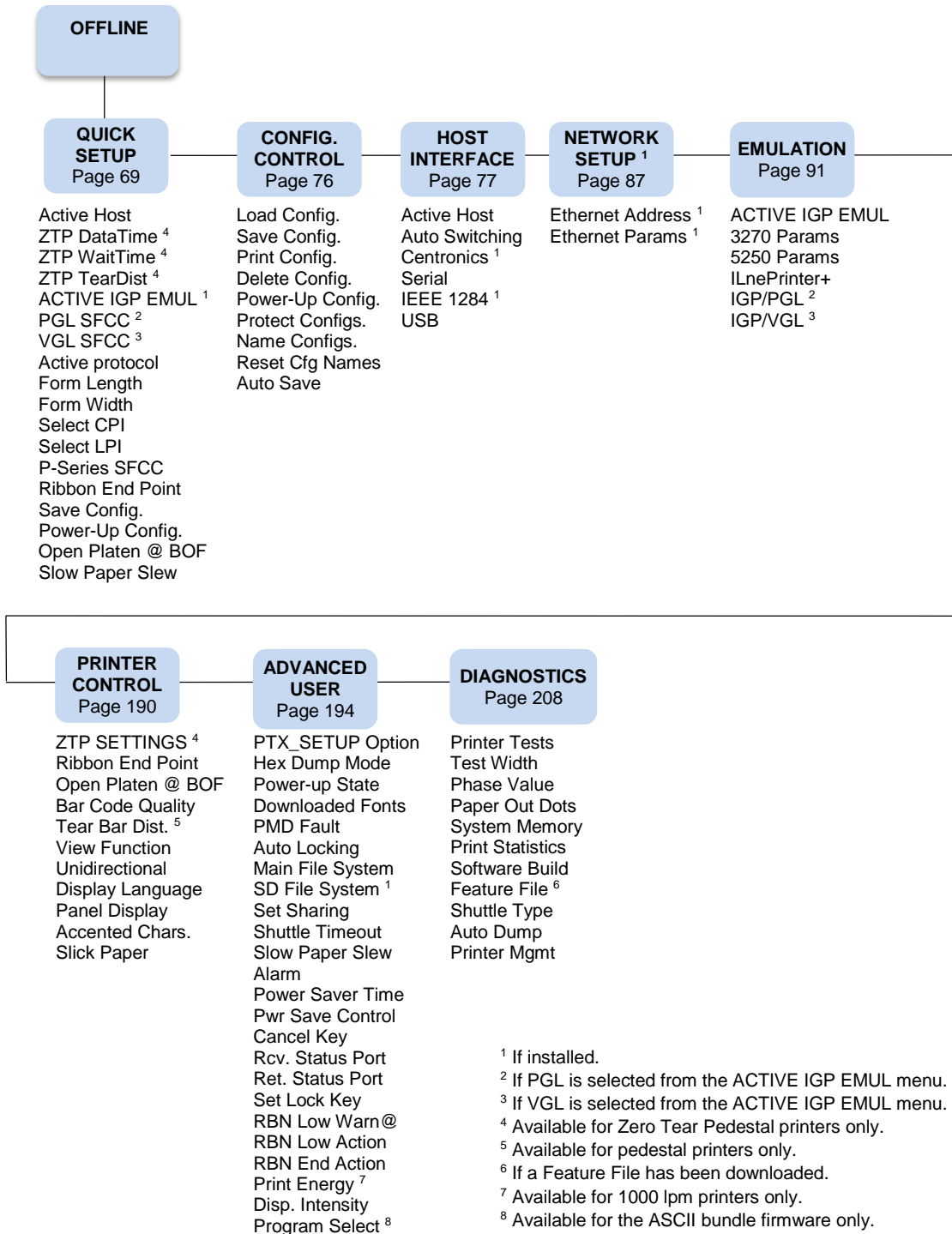

# P8000 PCL-II Firmware

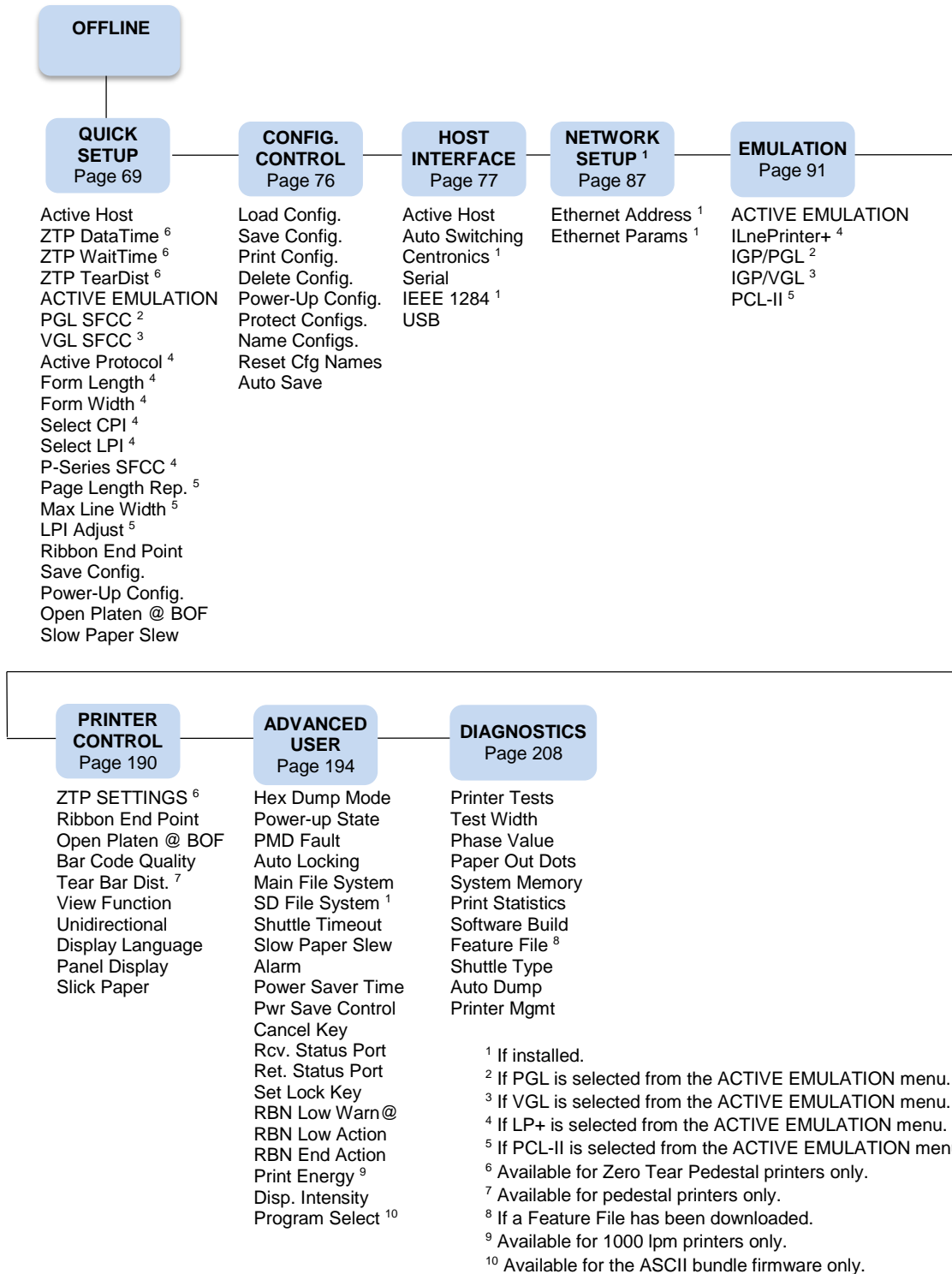

# P8000 LG Firmware

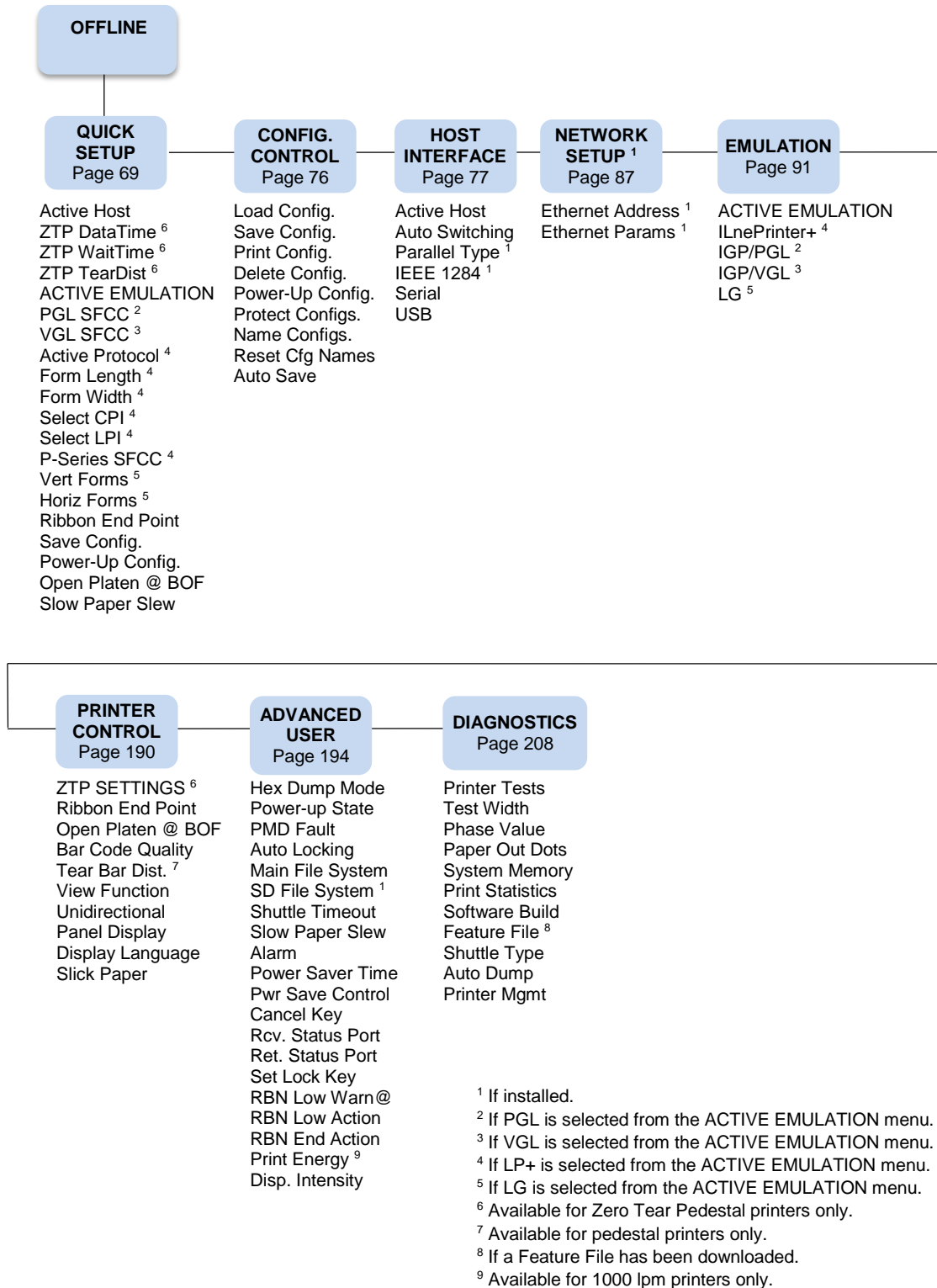

# P8000 ANSI Firmware

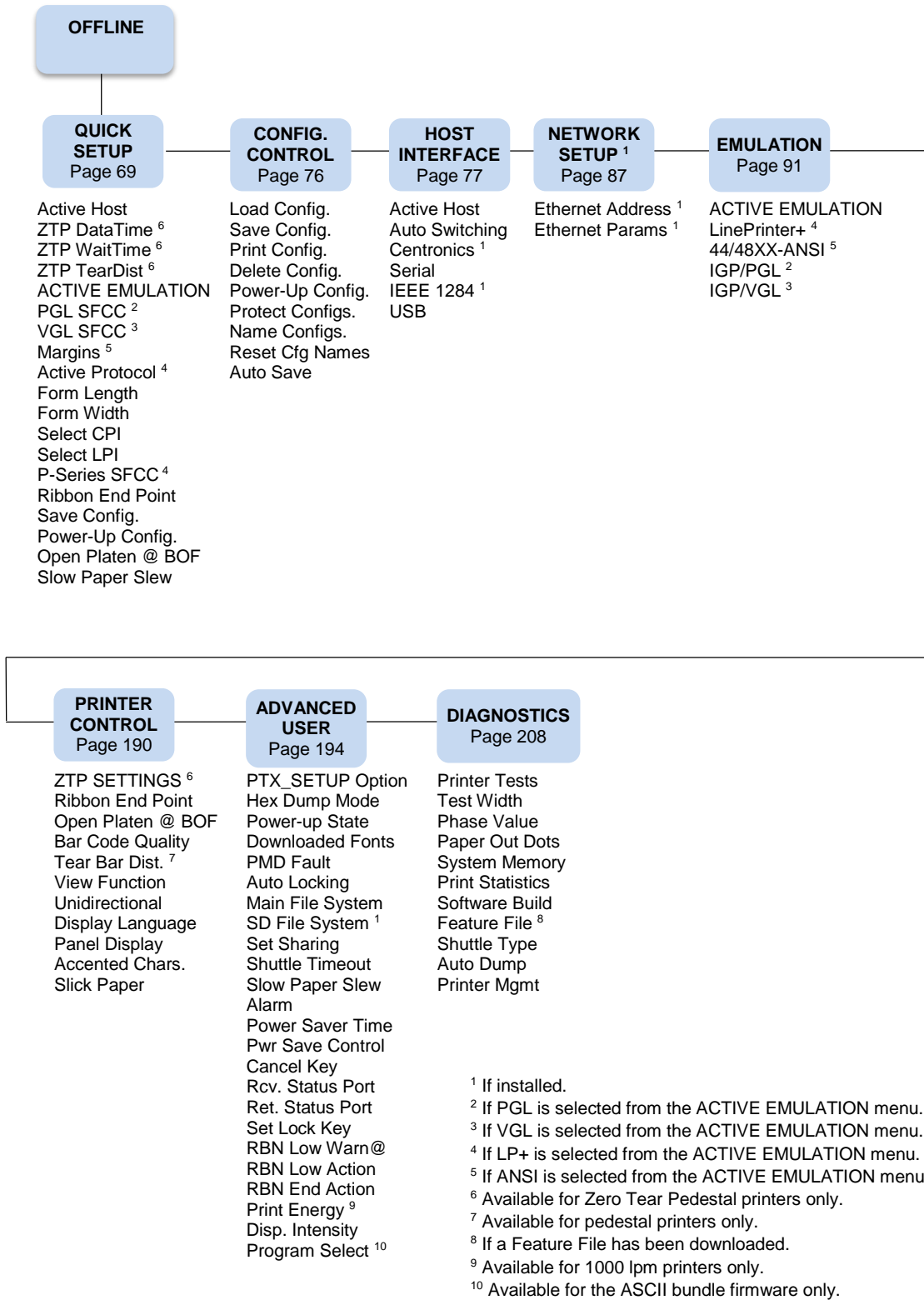

# OpenPrint P8000 Standard Postscript/PDF Firmware

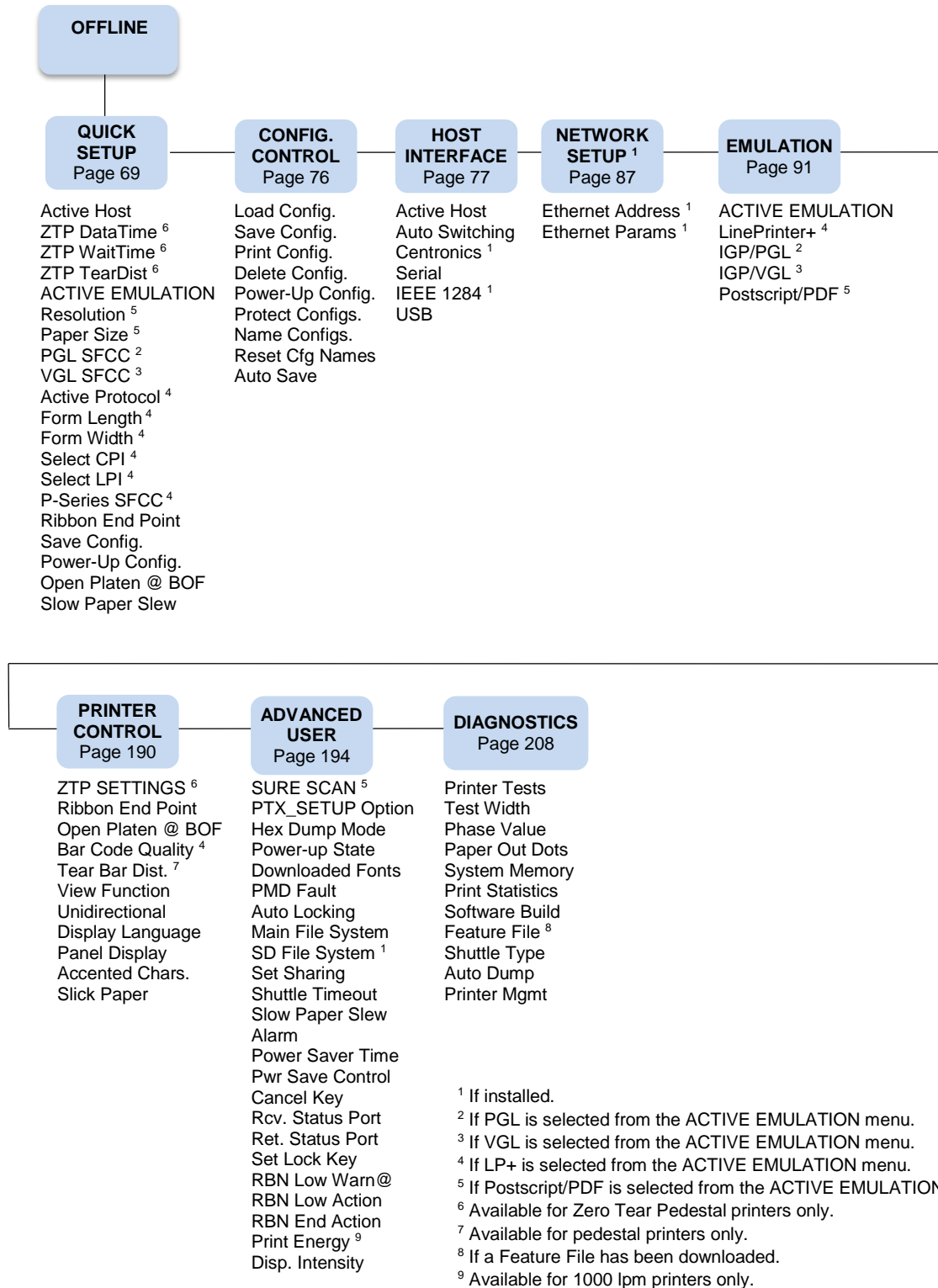

# OpenPrint P8000 HD Postscript/PDF Firmware

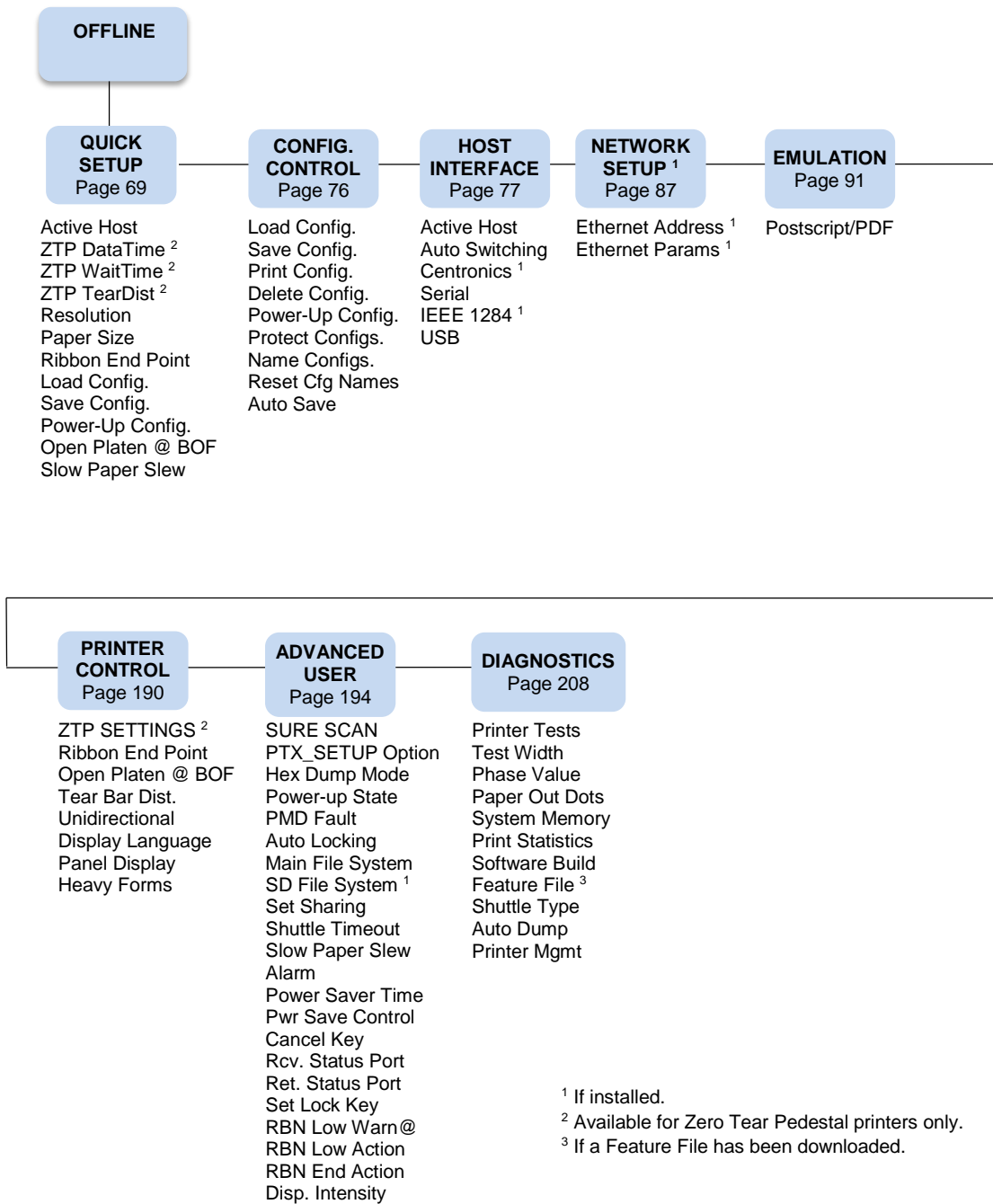



# H-Series Firmware



## OKI Menu

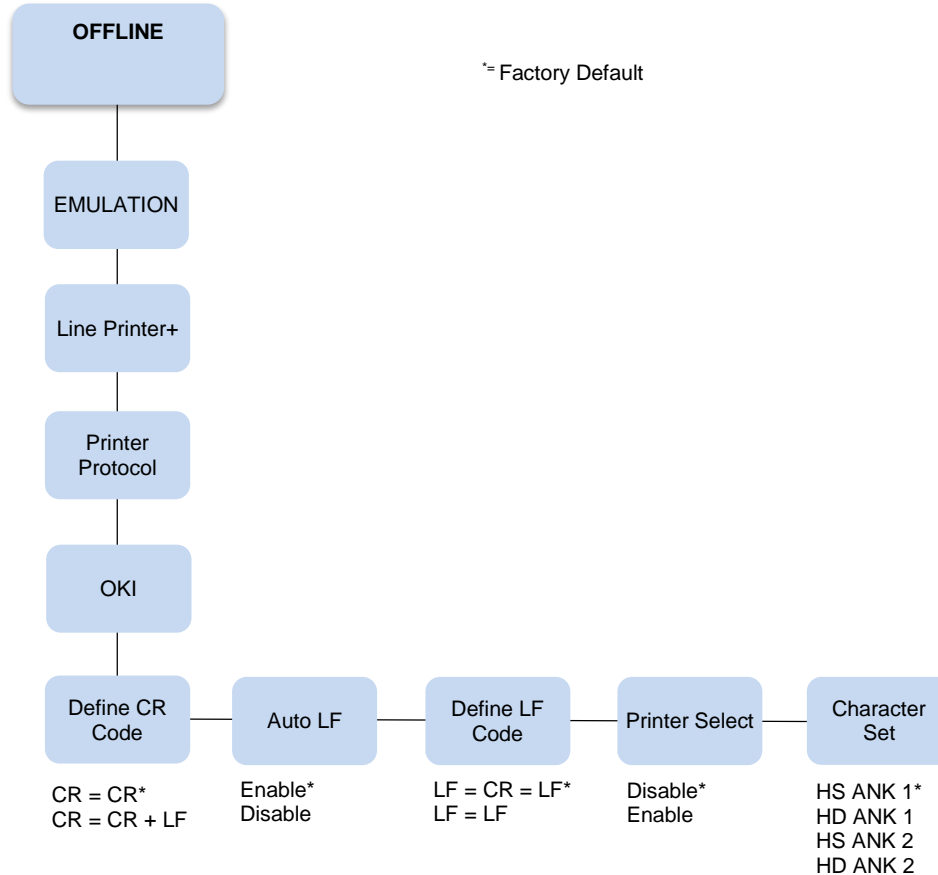

### Define CR Code

The Define CR Code option controls the action of the printer when it receives a Carriage Return code (hex 0D) from the host computer. If this feature is enabled, each time the printer receives a Carriage Return, it inserts an additional Line Feed code (hex 0A) into the data stream. Do not use this feature if the host computer sends Line Feeds to the printer.

- **CR = CR**. Does not insert an extra Line Feed after each Carriage Return.
- **CR = CR + LF**. Inserts an extra Line Feed after each Carriage Return.

### Auto LF

This option defines the printer actions when print data is received past the forms width setting.

- **Enable**. Performs an automatic carriage return and line feed when data is received past the forms width.
- **Disable**. Discards any data past the forms width.

### Define LF Code

The Define LF Code option controls the action of the printer when it receives a Line Feed code (hex 0A) from the host computer. If this feature is enabled, each time the printer receives a Line Feed, it inserts an additional Carriage Return code (hex 0D) into the data stream. This feature can be used in most installations, but it is required if the host computer does not send Carriage Returns to the printer.

- **LF = CR + LF.** Adds an extra Carriage Return with each Line Feed.
- **LF = LF.** Does not add a Carriage Return with a Line Feed.

### Printer Select

- **Disable.** Ignores the ASCII DC1 and DC3 control codes.
- **Enable.** Disables the printer when a DC1 control code is received, and enables the printer when a DC3 control code is received.

### Character Set

This parameter selects a character set for the Epson® emulation when LQ1600K is selected and for OKI emulation when OKI is selected.

### 20 CPI Condensed

Compressed print characters are narrower than the normal character set. This is helpful for applications for which you need to print the maximum amount of information on a page.

- **Enable.** Prints about 60 percent of the width of normal characters when compressed print is chosen by the host computer. For example, a 12 CPI Draft font will compress to 20 CPI.
- **Disable.** Does not compress print widths, even if condensed print is chosen by the host.

**NOTE:** This parameter is not available for Hanzi GB printers with OKI selected.

### Alt. Set 80-9F

- **Control Code.** Interprets data in the range of hex 80 through hex 9F as a control code.
- **Printable.** Prints data in the range of hex 80 through hex 9F.

**NOTE:** This parameter is not available for Hanzi GB printers with OKI selected.

### Currency Sign

- **RMB Select.** The ASCII code hex 24 is printed as a RMB “¥” character in DBCS mode. Default for GB.
- **\$ Select.** The ASCII code hex 24 is printed as a dollar “\$” character in DBCS mode.

**NOTE:** Available for H-Series GB firmware with LQ1600K selected only.

### AR3240

- **Disable.** AR3240 emulation does not take effect. Default.
- **Enable.** AR3240 takes effect, SUB (0x1A) is used as another SFCC. The listed commands will take effect and turn the extending table character on.

**NOTE:** Available for H-Series GB firmware with LQ1600K selected only.

# P8000 Indian and Arabic Language Firmware

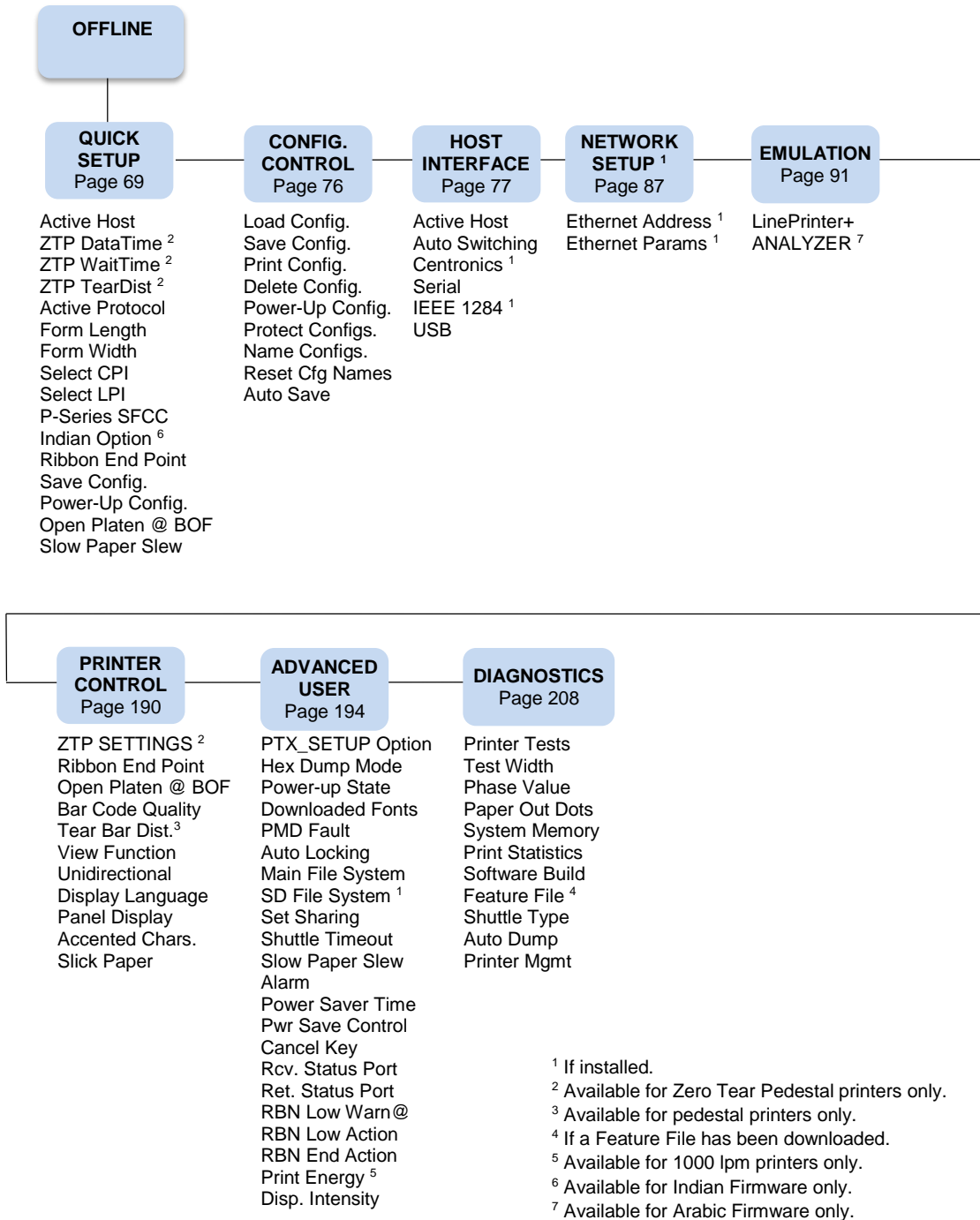

# QUICK SETUP Menu

When the printer is in offline mode, QUICK SETUP is the first Main Menu option that appears on the control panel. The QUICK SETUP menu offers basic menu items required to configure your printer. This section describes the options within the QUICK SETUP menu.

**NOTE:** The options in your menu will vary depending on the firmware, host IO, emulations selected, and other features available with your printer.

## Active Host

The Active Host menu enables you to select and configure interfaces between the printer and your host computer. The Auto Switching option (factory default) allows all ports to be active at the same time.

## ZTP DataTime

This option sets the pause time in the data stream that the ZTP requires before moving the form to the tear bar once a print job is completed. The values range from .5 to 5 seconds. The default is .5 seconds.

## ZTP WaitTime

This option sets the minimum amount of time that the form stays at the tear bar. This allows you time to remove the form before the form is retracted to print the next form. The adjustable values range from 500 to 5000 milliseconds in increments of 500 milliseconds. The default value is 2 seconds.

## ZTP TearDist

This option sets the tear off distance from the current print position to the tear bar. Adjustable values in increments of 1/144th of an inch range from 200 to 2880. The up and down arrows adjust the display value. When you press the ENTER key, the selected value is stored and a scale is printed to indicate the current tear off position. The default value is 1060.

**NOTE:** When a new value is selected, the printer will lose the current print position. You must reset the top of form to automatically save the new value.

## DBCS CPI (H-Series)

Defines the default values for horizontal character spacing in DBCS mode. For the Hanzi and Kanji LP+ printer, select from 5.0, 6.0, 6.7, 7.5, and Others CPI. For the Hangul LP+ printer, selected from 5.0, 6.0, 6.7, 7.5, 8.5, 10, and others CPI.

The factory default for the Hanzi LP+ printer is 6.7 cpi. The factory default for the Hangul LP+ printer is 6.0 cpi. The factory default for the Kanji LP+ printer is 7.5 cpi.

## DBCS/ASCII Mode (H-Series)

This option specifies the operating mode of the Hanzi printer. If set to DBCS mode, the printer can print double-byte characters and a limited number of single-byte characters. Otherwise, the printer can only print single-byte characters.

Available for the Hanzi and Kanji LP+ printers only.

## DBCS ASCII Style (H-Series)

This option specifies the appearance of the single-byte numeric characters. For the Hanzi and Kanji LP+ printer, select from Normal, Oversize and OCRB. For the Hangul LP+ printer, select from Normal, and OCRB.

If set to Oversize, the numeric characters will appear larger than other single-byte characters. For example, the appearance of character "8" will be changed to "8". If set to OCRB, the numeric characters will print in OCRB style.

### Graphics Spd-Up (H-Series)

This menu is used to increase (speed up) graphic printing speed by turning on Enhanced/Turbo mode.

- **Normal** (factory default). The printer prints at the given input graphics resolution.
- **Enhanced**. The printer provides first-level speed up, which means the speed is faster than Normal mode.
- **Turbo**. The printer provides second-level speed up, which means the printer is faster than Enhanced mode.
- **Match Typeface**. The input 180 x 180 dpi graphics resolution will drop- dot to the resolution matching the typeface selected.

### Typeface (H-Series)

Sets the typeface of the printer. This key requires confirmation with the ENTER key.

The factory default for the Hanzi GB and Kanji SJIS LP+ is Near LQ.

The factory default for the Hangul and Hanzi Big5 LP+ is LQ.

### Active Emulation

The Active Emulation menu enables you to select a combination of emulations as described in Table 4 on page 56.

### Active IGP Emulation

The Active IGP Emulation menu enables you to activate either the PGL or VGL emulation. This menu is only available with the P8000 Standard and TN firmware as described in Table 4 on page 56.

### PGL SFCC

You can specify which hex code (1-FF) will be used as the Special Function Control Character (SFCC). The SFCC denotes that the following data is an IGP command.

- **7E** (factory default)
- 1 – FF

### VGL SFCC

You can specify which hex code (1-FF) will be used as the Special Function Control Character (SFCC). The SFCC denotes that the following data is an IGP command.

- **5E** (factory default)
- 1 – FF

### Active Protocol

Select the LinePrinter+ protocol you wish to use. Refer to the *LinePrinter Plus Programmer's Reference Manual* for more information.

### Form Length

Form length is the number of lines that can be printed on a page. You can set the form length in inches, millimeters (mm), or as a function of the current lpi (lines per inch).

### Form Width

The form width can be specified in inches, millimeters, or as a function of the current cpi (characters per inch). The forms width set should not exceed the actual paper width.

### Select CPI

This parameter allows you to specify the characters per inch (cpi) values. The standard options are 10.0, 12.0, 13.3, 15.0, 17.1, and 20.0. The factory default is 10.0 CPI. Some special additions for certain firmware types:

- 6.0 CPI is also available for the Indian Language firmware.
- 16.7 and 18 CPI are also available for the ASCII firmware.

### Select LPI

This parameter allows you to specify the lines per inch (lpi) values.

- **ASCII:** The options are 6.0, 8.0, 9.0 and 10.3 LPI. The factory default is 6.0 LPI.
- **Indian Language:** All ASCII options are available with additional options 3.0, 4.0, 4.5, and 5.0 LPI.
- **H-Series:** The options are 6.0 or 8.0 LPI. The factory default for the Hanzi and Hangul LP+ is 6.0. The factory default for Kanji LP+ is 8.0.

### P-Series SFCC

This parameter allows you to select which ASCII codes will function as the Special Function Control Code (SFCC) command delimiter.

P-Series codes can use hex 00 through hex 7F. Options include the following:

- **SOH (hex 01)** (factory default)
- **ESC (hex 1B)**
- **ETX (hex 03)**
- **CIRCUMFLEX (hex 5E)** – also called caret (^)
- **TILDE (hex 7E)** – (~)

**NOTE:** SOH, ETX, and ESC are non-printables. The characters (^) and (~) are printable; however, do not use them as printables in the host data stream if either is chosen as a delimiter because print errors will occur.

### Margins

- **Left Margin.** Set in columns. Column zero is defined as the far left edge of the page, and column numbering increments from left to right.
- **Right Margin.** Set in columns. Column zero is defined as the far right edge of the page, and column numbering increments from right to left.
- **Top Margin.** Defined in lines, starting from line zero at the top of the page and incrementing from the top down.
- **Bottom Margin.** Defined in lines, starting from line zero at the bottom of the page and incrementing from the bottom up.

### Form Length

Form length is the number of lines that can be printed on a page. You can set the form length in inches, millimeters (mm), or as a function of the current lpi (lines per inch).

### Form Width

The form width can be specified in inches, millimeters, or as a function of the current cpi (characters per inch). The forms width set should not exceed the actual paper width.

### **Vert Forms (LG)**

- **Bot Frm 66/6** (factory default). This option sets the bottom margin for the forms. You must specify the bottom margin in lines (at 6 lines per inch), ranging from 0 to 198 lines (33 inches). The default setting is 66. Press the right arrow to increase the value, left arrow to decrease the value, and ENTER to change units. Selecting a value for this option resets the top margin to 0, so the top margin must be redefined after this option is selected.
- **Top Mrg 6/0** This option sets the top margin for the forms. You must specify the top margin in lines (at 6 lines per inch), ranging from 0 to 198 lines (33 inches). The default setting is 0. Press the right arrow to increase the value, left arrow to decrease the value, and ENTER to change units. The margins will automatically adjust so that the top and bottom margins do not cross each other.

### **Horiz Forms (LG)**

- **Left Mgr 0.00** (factory default). This sets the left margin for the forms. You must specify the left margin in 1/10 inch increments, from 0 to 13.1 inches. The default value is 0. Press the right arrow to increase the value, left arrow to decrease the value, and ENTER to change units. The margins will automatically adjust so that the left and right margins do not cross each other.
- **Right Mrg 13.2**. This sets the right margin for the forms. You must specify the right margin in 1/10 inch increments, from 0.1 to 13.2 inches. The default value is 13.2. Press NEXT to increase the value, PREV to decrease the value, and ENTER to change units. The margins will automatically adjust so that the left and right margins do not cross each other.

### **Page Length Rep (PCL-II)**

- **Inches/Page** (factory default). Allows the user to set the page length in inches.
- **Lines/Page**. Allows the user to set the page length in number of lines.

### **Max Line Width (PCL-II)**

Set the maximum line width at either 13.2 inches or the maximum width of the printer.

### **LPI Adjust (PCL-II)**

Set the lines per inch value for the PCL-II emulation.

### **Resolution (OpenPrint)**

This parameter defines the default print resolution. This selection is used when either the print resolution is not defined by the data stream or if the print resolution defined by the data stream is not supported.

The following resolutions are available on OpenPrint P8000 Standard:

- **120x144 DPI** (factory default)
- **90 x 96 DPI**

The following resolutions are available on OpenPrint P8000 HD:

- **180x180 DPI** (factory default)
- **180x90 DPI**
- **90x180 DPI**
- **120x120 DPI**
- **90x90 DPI**



## Paper Size (OpenPrint)

This parameter allows selection of available paper sizes. Available options include:

- **Custom.** Sets a user-defined paper size.
  - **Width.** Defines the paper width. The range is 1" to 15" in 0.1 inch increments. The default is 13.6 inches.
  - **Length.** Defines the paper length. The default is 11 inches. Three length options are available:
    - Inches.** Defines the length in inches. The range is 1" to 24" in 0.1 inch increments.
    - 1/6 Inch Lines.** Defines the length in 1/6 inch lines. The range is 6 to 144 lines.
    - 1/8 Inch Lines.** Defines the length in 1/8 inch lines. The range is 8 to 192 lines.

To set a custom length, use the appropriate menu that allows for selection of the exact paper length to avoid loss of top-of-form (i.e., if using a 12" paper, select either the "Inches" menu set to 12" or the "1/6 Inch Lines" menu set to 72. However, if using a 11 2/3 inch paper length, the "1/6 Inch Lines" menu must be used (set to 70) since that is exactly 11 2/3 inches. If the "Inches" menu is used, the closest values would be 11.6 or 11.7 inches which are not exact.

The printer will indicate which of the three length menus was used by showing that submenu first when entering the "Length" menu. The configuration printout will also show the length menu used.

- See Table 5 for paper size options and actual sizes.

**Table 5 Paper Size Options and Actual Size**

Paper Size	Actual Size
US Fanfold	13.6 x 11 in
Letter	8.5 x 11 in
Legal	8.5 x 14 in
Executive	7.3 x 10.5 in
A3	11.7 x 16.5 in
A4	8.3 x 11 2/3 in
A5	5.8 x 8.3 in
A6	4.1 x 5.8 in
Fanfold 10x14in	10 x 14 in
Tabloid 11x17in	11 x 17 in
Fanfold 12x12in	12 x 12 in
JIS B5	7.2 x 10.1 in
US Folio	8.5 x 13 in
No. 10 Envelope	4.1 x 9.5 in
DL Envelope	4.3 x 8.7 in
C5 Envelope	6.4 x 9 in
C6 Envelope	4.5 x 6.4 in
ISO B5	6.9 x 9.8 in

### Indian Option (Indian Language)

- **Indian Formatter.** The available options include Disable, Script Page, and Data Page.
  - **Disable** (factory default). The Indian characters will print without composing.
  - **Script Page.** Allows printing of Indian characters with composing for non-table format.
  - **Data Page.** Allows Indian character printing with composing for table- formatted data. Data Page does not support ESC sequence commands nor other single byte commands except for CR, LF, FF, BEL, DC1, and DC3.
- **Tall ASCII Font.** The available options include enable and disable.
  - **Disable** (factory default).
  - **Enable.** When enabling the Tall ASCII Font setting, the ASCII characters will print as tall fonts. This setting is available only for 10, 12, and 13.3 CPI for DP and NLQ settings. It is recommended to print the Tall ASCII font with 4 LPI setting or lower to avoid overlapping.
- **Space Width Adj.** The values range from 1 to 30. The default value is 12. This option allows spacing adjustment between the words in Indian character printing. This feature works only with Indian code pages and not with Standard code pages. The Space Width Adj value affects the character width of the space character (0x20) and the dash character (0x2D). The Space Width Adjust value is applicable to both script page and data page selections. Table 6 shows the space width adjustment value according to its typeface and CPI setting.

**Table 6 Typeface, CPI, and Space Width Values on Indian Language printers**

Typeface	CPI	Space Width
Data Processing	6	20
	10	12
	12	10
	13.3	9
	15	8
	17.1	7
	20	6
Near Letter Quality	6	30
	10	18
	12	15
	13.3	13
	15	12
	17.1	10

- **Hindi Numeral.** Allows you to specify whether to print numbers as Hindi numerals.
  - **Disable** (factory default)
  - **Enable.** When enabled, numbers will print as Hindi numerals.

### **Ribbon End Point**

This parameter adjusts the point at which the system will declare the ribbon as being expended. The life count will always be from 100% to 0%, but if a darker setting is selected 0% will be reached more quickly. If a lighter setting is selected, the system will extend the time it takes to reach 0%.

### **Load Config.**

The printer can store numerous configurations in memory. This parameter allows you to select and load a specific configuration.

### **Save Config**

This option allows you to save up to eight configurations to meet different print job requirements. This eliminates the need to change the parameter settings for each new job. The configurations are stored in memory and will not be lost if you turn off the printer. If the Protect Configs. parameter is enabled, the new configuration will not be saved unless the existing configuration has been deleted first. The factory default configuration cannot be changed. See Saving Your New Configuration on page 49 for details.

### **Power Up Config**

This option allows you to specify which of the nine configurations (Factory or 1-8) will be the power-up configuration.

### **Open Platen @ BOF**

Some special forms have perforation areas that are too thick to pass through the print station. This parameter, when enabled, opens and closes the platen when the perforations move across the platen. When enabling this parameter, you must set the forms length to match the physical distance between perforations

### **Slow Paper Slew**

- **Disable** (factory default). The paper will slew and stack paper at maximum speed.
- **Enable**. Causes the paper to stack at a slower rate. This ensures that certain forms will stack neatly.

# CONFIG. CONTROL Menu

The CONFIG. CONTROL menu allows you to control your printer's configurations according to the specifications necessary for your print jobs.

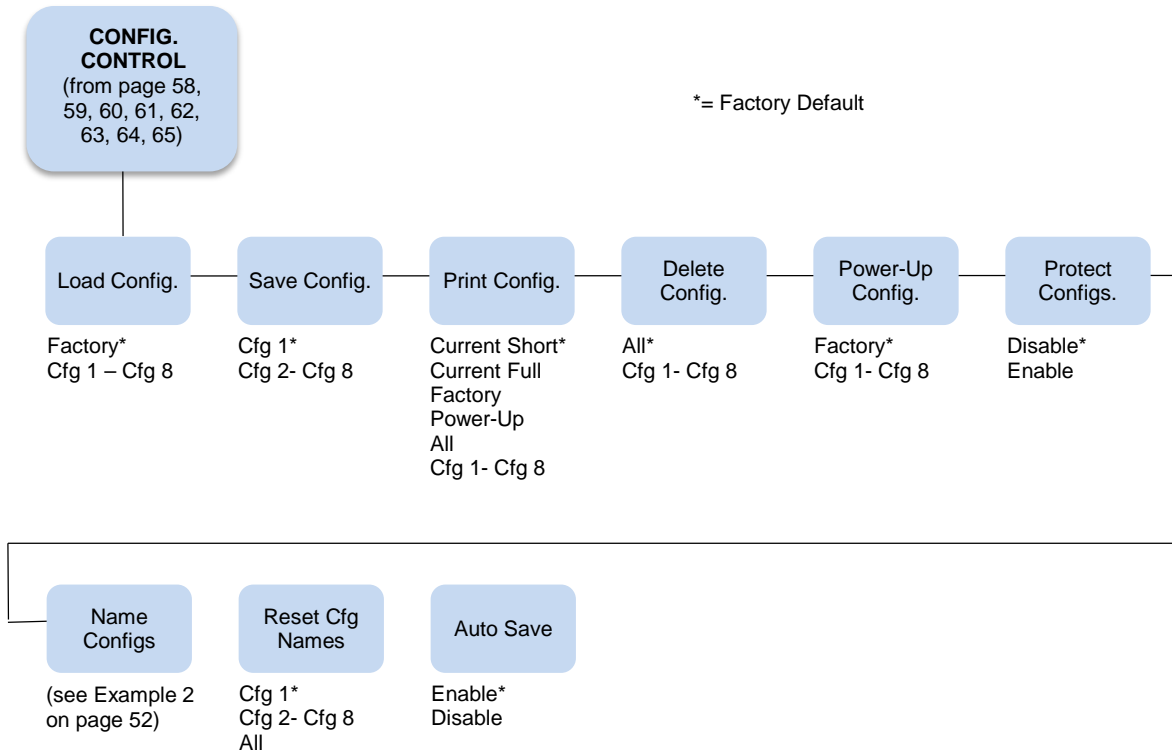

## Load Config.

The printer can store numerous configurations in memory. This parameter allows you to select and load a specific configuration.

## Save Config.

This option allows you to save up to eight configurations to meet different print job requirements. This eliminates the need to change the parameter settings for each new job. The configurations are stored in memory and will not be lost if you turn off the printer. If the Protect Configs. parameter is enabled, the new configuration will not be saved unless the existing configuration has been deleted first. The factory default configuration cannot be changed. See Saving Your New Configuration on page 49 for details.

## Print Config.

This option is used to print a listing of various stored printer configurations. Store printouts of your configurations in a safe place for quick referral.

## Delete Config.

You can delete one or all of your eight customized configurations. The factory default configuration cannot be deleted.

## Power-Up Config.

You can specify which of the nine configurations (Factory or 1-8) will be the power-up configuration.

## Protect Configs.

You can specify whether or not a new configuration should overwrite an existing configuration when you activate the Save Configs. parameter. When disabled (factory default), the new configuration will overwrite the existing configuration. When enabled, the new configuration will *not* overwrite the existing configuration, and the message "CONFIG. EXISTS / Delete First" displays.

## Name Configs

This option allows you to rename any of the eight different configurations.

You may specify a 15-character name which can be used to refer to a configuration. The name you enter for a configuration will be used in the Load Config., Save Config., Print Config., Delete Config., and Power-Up Config. menus. The name can only be cleared by using the Reset Cfg Names menu. See example 2 on page 52 on how to name configurations.

## Reset Cfg Names

You can reset specific configuration names back to the default value of the configuration number.

## Auto Save

- **Enable** (factory default). When a change has been made to a Config. menu, this option automatically prompts the user to save or not save the change to a Config #.

If you are currently in the Factory Config. menus and make a change, pressing ENTER saves to Config 1 or the next available Config. and becomes the Power-Up Config. If the Current Config is Config 1 and a menu change is made, pressing ENTER will save the change to Config 1.

- **Disable**. The printer will not prompt you to save any changes made.

# HOST INTERFACE Menu

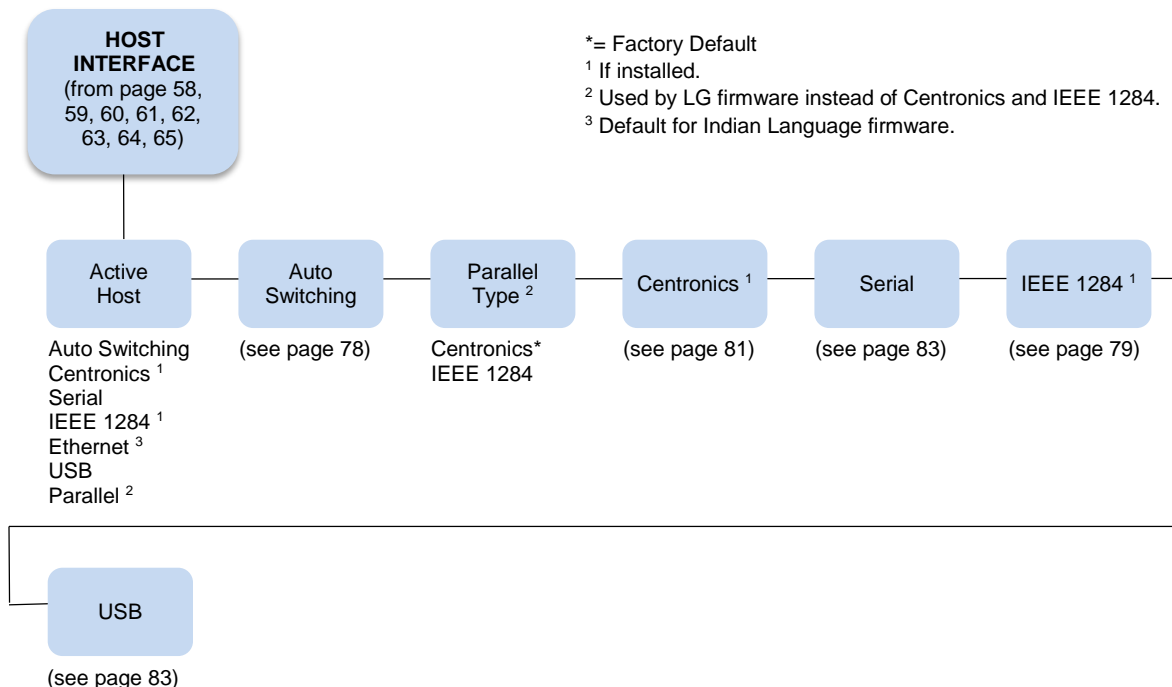

The Host Interface Menu enables you to select and configure one of many types of interfaces between the printer and your host computer. The currently selected interface is indicated with an asterisk on the control panel message display. Each interface has its own submenu with a set of interface parameters which can be configured.

**IMPORTANT** When set to Auto Switching, the printer will load the power-up configuration and the new interface parameters. Any settings made and not saved before selecting these interfaces will be lost.

## Auto Switching Submenu

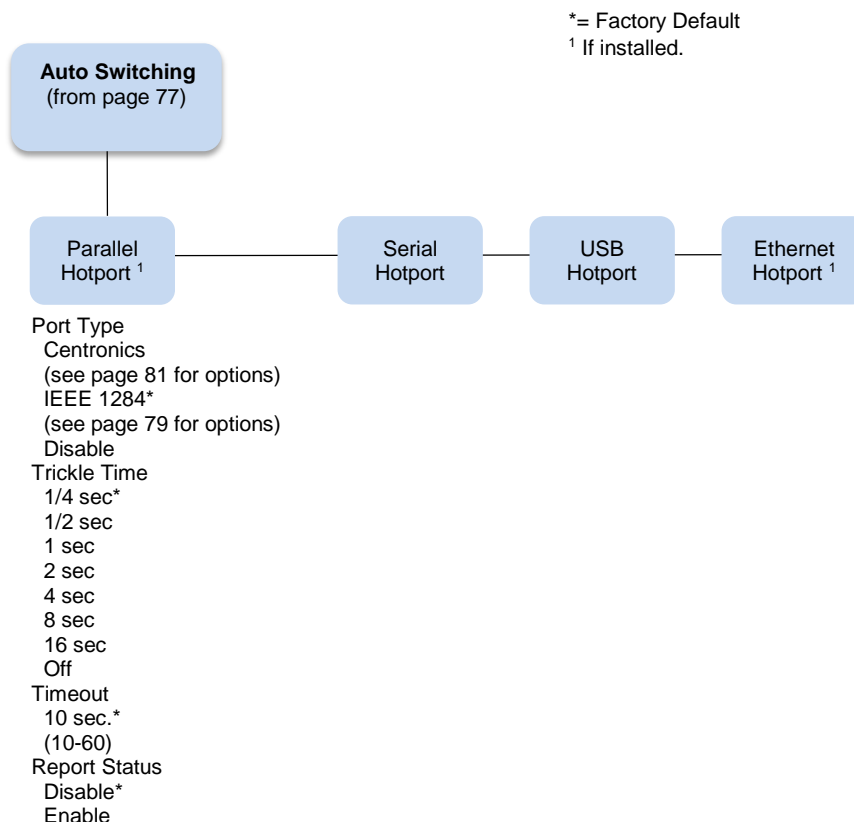

Auto Switching gives the printer the ability to handle multiple data streams sequentially. With Auto Switching, the printer can service hosts attached to the serial, parallel, USB, and Ethernet ports as if they were the only interface connected.

For example, if the host computer sends one print job to the RS-232 serial port and a separate print job to the IEEE 1284 parallel port, the printer's Auto Switching is able to handle both jobs, in the order they were received. The user does not have to reconfigure the selected interface between jobs.

### Port Type

Select the parallel interface type connected to the printer. For example, if your printer is attached to one host with a Centronics connection, you would select Centronics under the Parallel Hotport menu.

## Trickle Time

When the printer is printing data from a host and a second job is received by the printer from a different host, Trickle Time prevents the second host from timing out while it is waiting for its data to be printed. In order to support this feature, the port has to be able to accept data from the host and store it for future use.

For example, if the printer is printing a job from the serial port, and then receives a second print job from the parallel or USB port, the data from the parallel or USB port will “trickle” bit by bit into the printer buffer to prevent a timeout error from being sent back to the host connected to the parallel port.

The selected value is the time that the printer waits before getting the next byte of data from the host. The Trickle Time value should be less than the host time out value, but not too much shorter or else the printer fills up its buffer too fast.

## Timeout

This is the value used by the printer to time out from the current port and check the other selected port types for data to print. When the printer has not received data from the host after a certain period of time, it needs to timeout in order to service the other ports.

## Report Status

- **Disable** (factory default). When a fault occurs on the printer, only the active port reports the fault to the host.
- **Enable**. The port will report any fault even when it is not the current active port.

## Switch Out On

**NOTE:** This option is only available under Ethernet Hotport.

- **Data Timeout** (factory default). Allows Autoswitching when no data has been received for the selected Time Out period.
- **Session Close**. Allows Autoswitching only when the Network Socket is closed. If the Ethernet option is not installed the Network Socket is always reported as closed and this menu option is ignored.

## IEEE 1284 Parallel (Bidirectional) Submenu

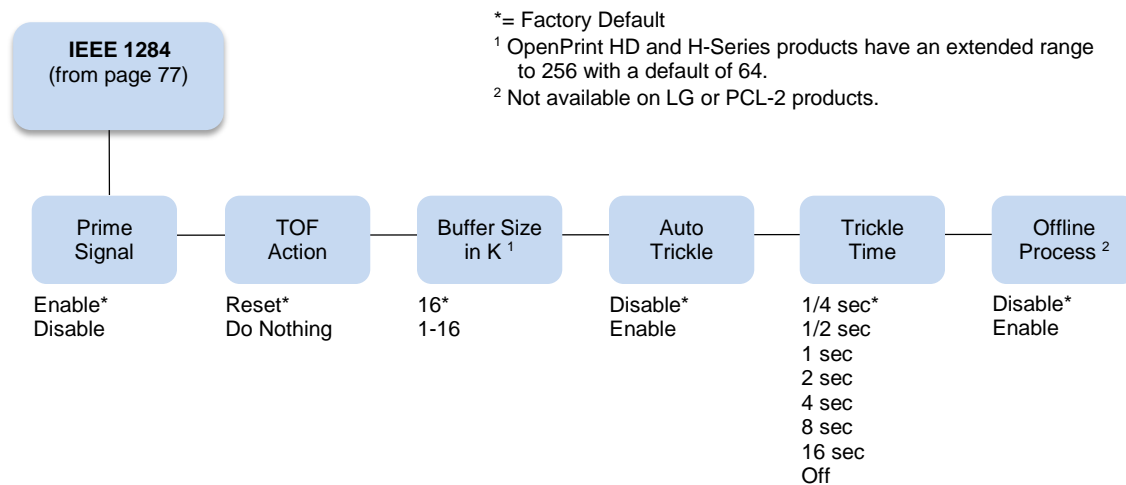

The IEEE 1284 interface is faster and more versatile than Centronics and supports bidirectional communication. Configuration of this interface is controlled from the host. Refer to IEEE 1284 Parallel Interface on page 217 for more details about the available modes (Compatibility, Nibble, and Byte).

### Prime Signal

- **Enable** (factory default). The parallel port will perform a warm start (reboot) if the host asserts the prime signal.
- **Disable**. The parallel port will not perform a warm start (reboot) if the host asserts the prime signal.

### TOF Action

- **Reset** (factory default). A form feed is performed before a warm start when the prime signal is asserted from the host. This setting is used only if the prime signal parameter is enabled.
- **Do Nothing**. Nothing occurs before a warm start when the prime signal is asserted from the host.

### Buffer Size in K

This option configures the amount of memory allocated for the IEEE 1284 parallel port buffer. You can specify between 1 and 16 Kbytes, in 1-Kbyte increments. The default is 16K.

**NOTE:** H-Series and OpenPrint HD products have a range of 1 to 256 and a default of 64K.

### Auto Trickle

Auto Trickle is used to prevent a host computer from timing out because the parallel interface was busy for too long. When Auto Trickle is enabled and the printer's buffers are almost full, the printer will begin to trickle data in (at the rate set in the Trickle Time menu) until the buffers start to empty.

### Trickle Time

When the printer is printing data from a host and a second job is received by the printer from a different host, Trickle Time prevents the second host from timing out while it is waiting for its data to be printed. In order to support this feature, the port has to be able to accept data from the host and store it for future use.

For example, if the printer is printing a job from the serial port, and then receives a second print job from the parallel port, the data from the parallel port will “trickle” bit by bit into the printer buffer to prevent a timeout error from being sent back to the host connected to the parallel port.

The selected value is the time that the printer waits before getting the next byte of data from the host. The Trickle Time value should be less than the host time out value, but not too much shorter or else the printer fills up its buffer too fast.

### Offline Process

- **Disable** (factory default). When set to disable, the printer does not process parallel data while offline.
- **Enable**. When set to enable, the printer continues to process (but not print) the current parallel job while the printer is offline until the printer's buffer is full.



## Centronics (Parallel) Submenu

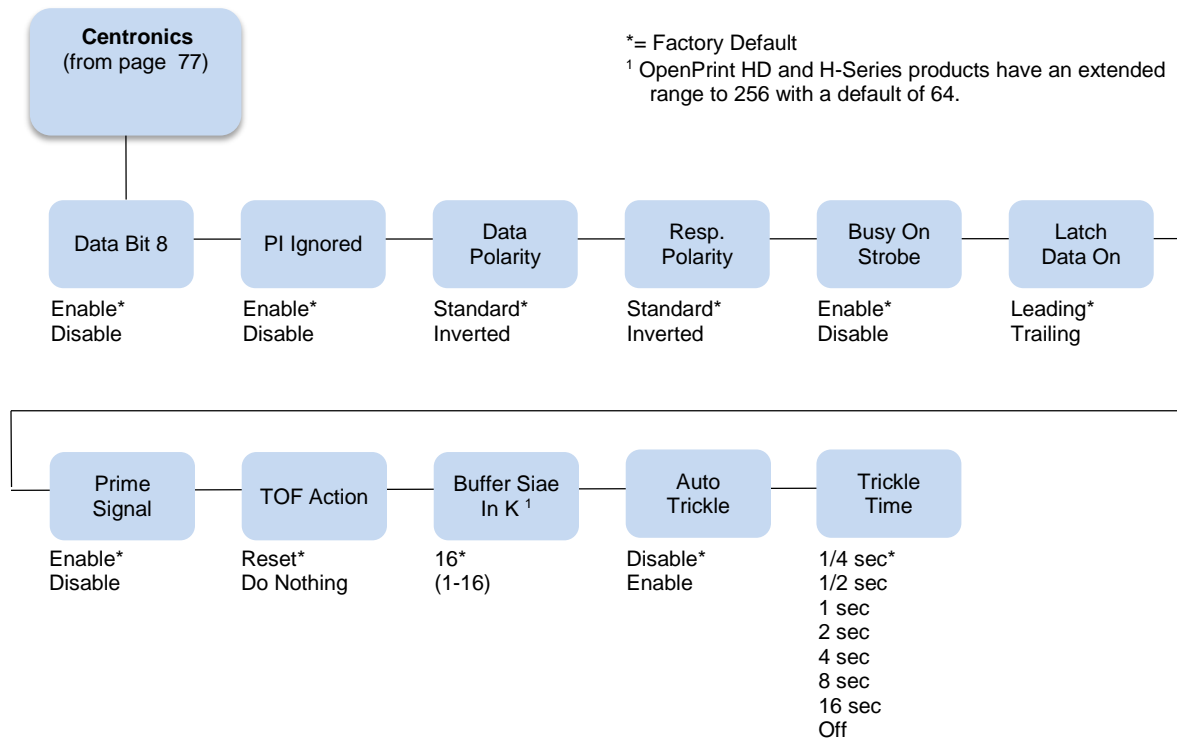

### Data Bit 8

- **Enable** (factory default). Allows access to the extended ASCII character set.
- **Disable**. The printer interprets bit 8 of each incoming data character as a zero, regardless of its actual setting.

### PI Ignored

The PI (Paper Instruction) signal is used to control vertical paper motion.

- **Enable** (factory default). Ignores the PI signal and treats the data as characters or control codes.
- **Disable**. Causes the printer to interpret the eight data lines as VFU commands when the PI signal is true.

### Data Polarity

The Data Polarity parameter must be set to match the data polarity of your host computer.

- **Standard** (factory default). Does not expect the host computer to invert the data.
- **Inverted**. Expects the data received on the data lines from the host computer to be inverted. Ones become zeros, and vice versa.

### Resp. Polarity

The Resp. Polarity parameter must be set to match the response polarity of your host computer.

- **Standard** (factory default). Does not invert the response signal.
- **Inverted**. Inverts the response signal sent to the host computer.

### **Busy On Strobe**

- **Enable** (factory default). Asserts a busy signal after each character is received.
- **Disable**. Asserts a busy signal only when the print buffers are full.

### **Latch Data On**

Specifies whether the data is read on the leading or trailing edge of the data strobe signal. The default is leading.

### **Prime Signal**

- **Enable** (factory default). The parallel port will perform a warm start (reboot) if the host asserts the prime signal.
- **Disable**. The parallel port will not perform a warm start (reboot) if the host asserts the prime signal.

### **TOF Action**

- **Reset** (factory default). A form feed is performed before a warm start when the prime signal is asserted from the host. This setting is used only if the prime signal parameter is enabled.
- **Do Nothing**. Nothing occurs before a warm start when the prime signal is asserted from the host.

### **Buffer Size in K**

Configures the amount of memory allocated for the Centronics parallel port buffer. You can specify between 1 and 16 Kbytes, in 1-Kbyte increments. The default is 16K.

**NOTE:** H-Series and OpenPrint HD products have a range of 1 to 256 and a default of 64K.

### **Auto Trickle**

Auto Trickle is used to prevent a host computer from timing out because the parallel interface was busy for too long. When Auto Trickle is enabled and the printer's buffers are almost full, the printer will begin to trickle data in (at the rate set in the Trickle Time menu) until the buffers start to empty out.

### **Trickle Time**

When the printer is printing data from a host and a second job is received by the printer from a different host, Trickle Time prevents the second host from timing out while it is waiting for its data to be printed. In order to support this feature, the port has to be able to accept data from the host and store it for future use.

For example, if the printer is printing a job from the serial port, and then receives a second print job from the parallel or USB port, the data from the parallel or USB port will "trickle" bit by bit into the printer buffer to prevent a timeout error from being sent back to the host connected to the parallel port.

The selected value is the time that the printer waits before getting the next byte of data from the host. The Trickle Time value should be less than the host time out value, but not too much shorter or else the printer fills up its buffer too fast.

## Serial Submenu

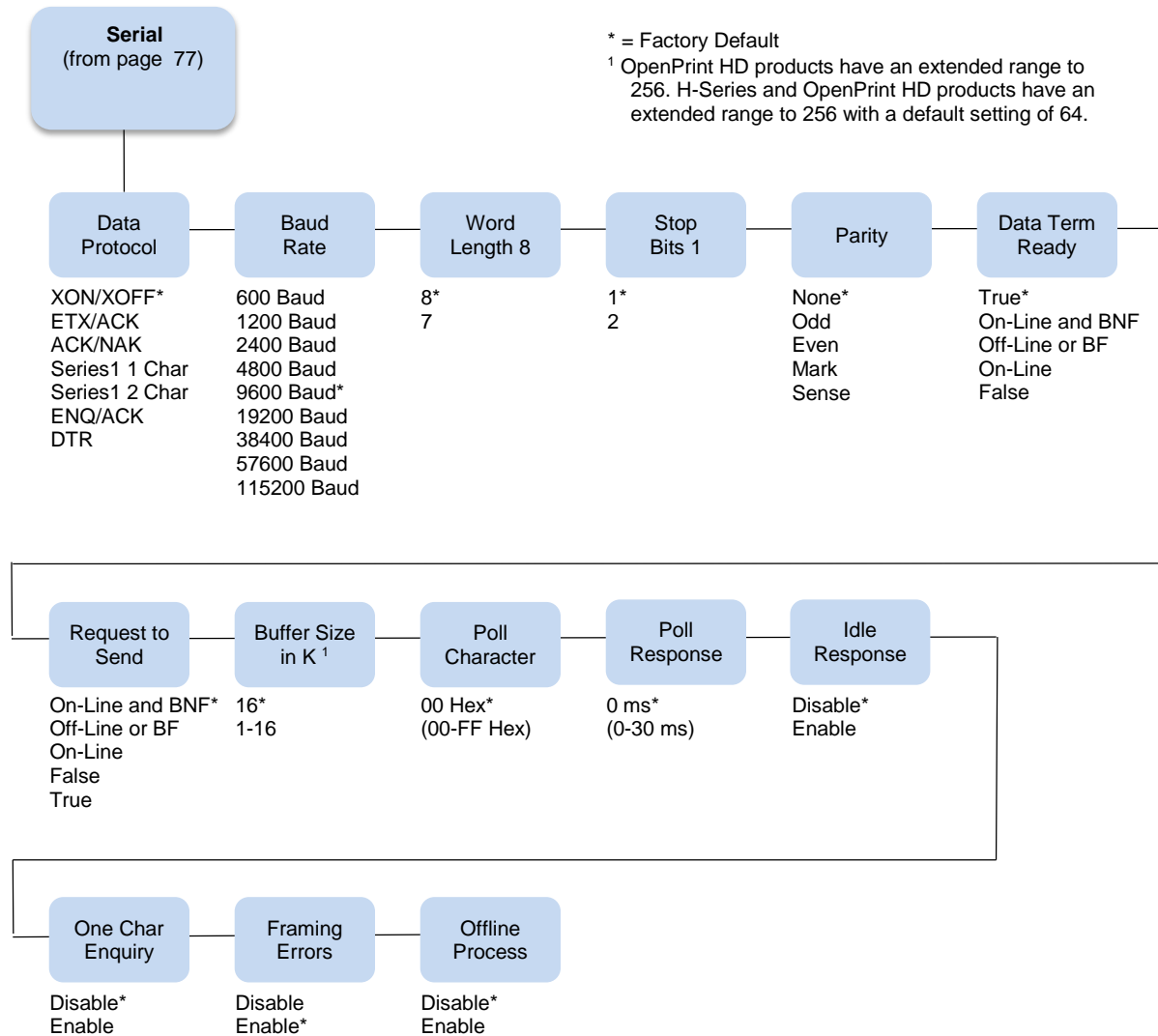

### Data Protocol

You can select one of the following serial interface protocols to meet the host interface requirements.

- **XON / XOFF** (factory default). The printer controls the flow of communication from the host by turning the transmission on and off. In some situations, such as when the buffer is full or the timing of signals is too slow or too fast, the printer will tell the host to stop transmission by sending an XOFF character. An XOFF character is sent when the number of empty bytes in the buffer is less than or equal to 25 percent of the buffer size. If the host keeps sending data after an XOFF is sent, the printer firmware will continue to send an XOFF for every 16 characters received. When cleared, the printer will resume receiving data (XON). The data does not have any End of Text codes; XON / XOFF is a non- block protocol.
- **ETX / ACK**. End of Text / Acknowledge. The host controls the flow of communication to the printer by sending a block of data and ending the block with an End of Text (ETX) signal. When the printer

receives the ETX signal, it will acknowledge the ETX, thereby acknowledging it has received the entire block of data.

- **ACK / NAK.** ACK means acknowledge; the device acknowledges it has accepted a transmission. NAK means negative acknowledge; the device did not receive the transmission.
- **SERIES1 1 CHAR.** The printer controls the flow of communication from the host by turning the transmission on and off using response characters sent to the host. If the number of valid bytes in the buffer reaches 75 percent of the buffer size, the online or offline and buffer full response character is sent. If the buffer is completely full, an online or offline buffer full response is sent every time a character is sent from the host. Whenever the printer state changes to online or offline, the appropriate response character is sent. If the idle response option is enabled, the printer will send a response character every two seconds while the number of valid bytes in the buffer is less than 75 percent of the buffer size. If a poll character is received (configurable from the Poll Character xx Hex option on the front panel from hex 0 through FF), the printer will send a response character *n* milliseconds later (configurable from the Poll Character xx MS on the front panel from 0 through 30). This *n* milliseconds is called the poll delay. The poll character will be removed from the input data stream and will not be processed. This may cause problems with the transmission of binary data (e.g., control codes, bit image, etc.). If a poll delay is started due to the receipt of a poll character and another poll character is received, the second poll character has no effect and is removed from the input data stream. If a transition (from buffer full to empty or online to offline) occurs during a poll delay, the new printer state will be sent at the end of the poll delay.

The response characters are described in Table 7.

**Table 7 Series1 Char Response Characters**

Printer State	Response
Online and Buffer Empty	CR
Online and Buffer Full	3
Offline and Buffer Empty	0
Offline and Buffer Full	2

- **SERIES1 2 CHAR.** This protocol behaves exactly the same as the Series1 Char except there is a two-character response to the host. The response characters are described in Table 8.

**Table 8 Series1 2 Char Response Characters**

Printer State	Response
Online and Buffer Empty	1 CR
Online and Buffer Full	3 CR
Offline and Buffer Empty	0 CR
Offline and Buffer Full	2 CR

- **ENQ/ACK.** Enquiry/Acknowledge. The host controls the flow of data by sending an ENQ (Enquiry, decimal 5, Control-E) approximately every 80 characters. When the printer is ready for more data, it replies with an ACK (Acknowledge, decimal 6, Control-F).

- **DTR.** The printer controls the data flow by sending this hardware signal to the host. If there is enough room in the printer buffer, the printer will send a high signal; if the buffer is full, the printer will send a low signal. DTR tells the host if it is safe to send more data. (If the host sends data during an unsafe condition, data will be lost.)

### **Baud Rate**

Sets the baud rate of the serial interface in the printer. Baud rate is the speed at which serial data is transferred between the host computer and the printer. The choices for the RS-232 interface are 600, 1200, 2400, 4800, 9600, 19200, 38400, 57600, and 115200 Baud. The default is 9600 Baud.

**NOTE:** If you select a baud rate that is greater than 19200, you may also want to increase the Buffer Size in K parameter to improve performance.

### **Word Length**

Sets the length of the serial data word. The length of the data word can be set to 7 or 8 bits, and must match the corresponding data bits setting in the host computer.

### **Stop Bits 1**

Sets the number of stop bits in the serial data word. Either one or two stop bits can be selected. The setting must match the corresponding stop bit setting in the host computer.

### **Parity**

Set for odd parity, even parity, mark, sense, or no parity. The setting must match the corresponding parity setting in the host computer.

### **Data Term Ready**

This configuration is part of hardware flow control and determines when the Data Terminal Ready (DTR) signal is generated. This signal indicates if the printer is ready to receive data.

- **True** (factory default). Continuously asserts the DTR signal.
- **On Line and BNF (buffer not full).** Asserts the DTR signal when the printer is online and the internal serial buffer is not full.
- **Off Line or BF (buffer full).** Asserts the DTR signal when the printer is offline or the internal serial buffer is full.
- **On Line.** Asserts the DTR signal when the printer is online.
- **False.** Never asserts the DTR signal.

### **Request To Send**

This configuration is part of hardware flow control and determines when the Request to Send (RTS) signal is generated. This signal indicates whether or not the printer is ready to receive data.

- **On Line and BNF** (factory default). Asserts the RTS signal when the printer is online and the internal serial buffer is not full.
- **Off Line or BF.** Asserts the RTS signal when the printer is offline or the internal serial buffer is full.
- **On Line.** Asserts the RTS signal when the printer is online.
- **False.** Never asserts the RTS signal.
- **True.** Continuously asserts the RTS signal.

## Buffer Size in K

This option configures the amount of memory allocated for the serial port buffer. You may specify between 1 and 16 Kbytes, in 1-Kbyte increments. The default is 16K.

- NOTE:** 1. If you select a baud rate that is 19200 or greater, you may want to increase the Buffer Size in K parameter to improve performance.
2. H-Series and OpenPrint HD products have a range of 1 to 256 and a default of 64K.

## Poll Character

This option is for the Series1 protocol. Whenever the printer receives this character, it sends a response to the host indicating the current state of the printer (see Series1 protocol). It may be configured from 0 through FF hexadecimal.

## Poll Response

This option is for the Series1 protocol. After receiving a poll character, the printer will wait the poll response time in milliseconds before sending the response. It may be configured from 0 through 30.

## Idle Response

This option is for the Series1 protocol.

- **Disable** (factory default)
- **Enable.** The printer will send a response character every two seconds while the number of valid bytes in the buffer is less than 75 percent of the buffer size.

## One Char Enquiry

The One Char Enquiry mode uses the Poll Character to detect a request from the host and sends a response back to the host. This option also allows you to turn on and off this feature.

**Table 9 One Char Enquiry Response Characters**

Printer State	Response (hex)
Online and Buffer Not Full	22
Online and Buffer Full	23
Offline and Buffer Not Full	20
Offline and Buffer Full	21

The Poll Character is removed from the data stream. If the Data Protocol is set to ETX/ACK, ACK/NAK, or Series 1, One Char Enquiry is automatically disabled.

## Framing Errors

Possible errors that can occur when the printer's serial interface settings do not match those of the host computer.

- **Enable** (factory default). If a framing error occurs, a fault message will display on the control panel.
- **Disable.** If a framing error occurs, a fault message will not display on the control panel.

## Offline Process

- **Disable** (factory default). When set to disable, the printer does not process serial data while in offline mode.
- **Enable**. When set to enable, the printer continues to process without printing the current serial job while the printer is offline until the printer's buffer is full.

## NETWORK SETUP Menu

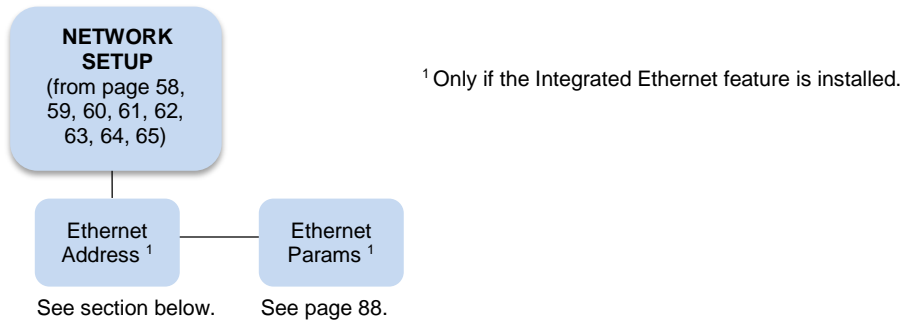

## Ethernet Address

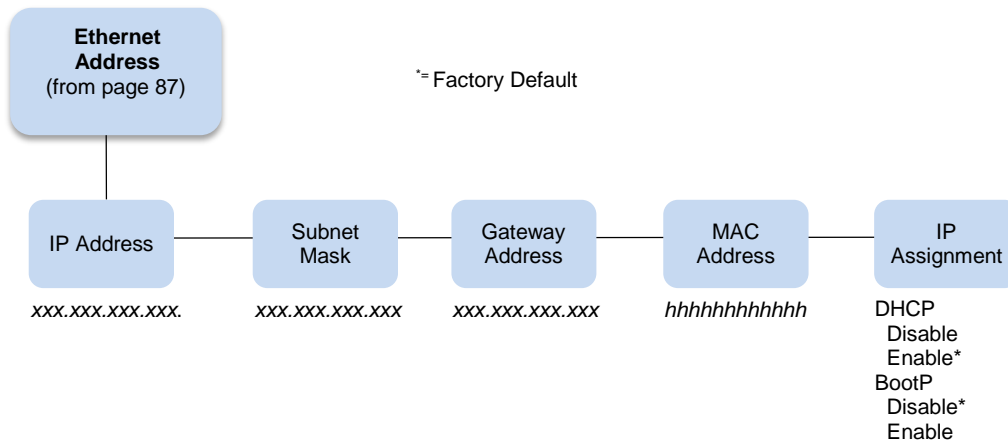

### IP Address

A numeric address such as 123.45.61.23 which identifies a printer or server in a LAN or WAN.

### Subnet Mask

A binary value used to divide IP networks into smaller subnetworks or subnets. This mask is used to help determine whether IP packets need to be forwarded to other subnets.

### Gateway Address

A gateway address is the IP address of a hardware device (gateway) that translates data between two incompatible networks, which can include protocol translation.

### MAC Address

This menu item is the Manufacturer's Assigned Number, and is unique for each printer. It is read-only.

## IP Assignment

This menu provides two options to control IP Assignment: DHCP and BootP.

- **DHCP.** You can enable/disable the DHCP protocol using this option, but consult your administrator for the appropriate setting. Options include Disable and Enable (factory default).
- **BootP.** You can enable/disable the BootP protocol using this option, but consult your administrator for the appropriate setting. Options include Disable (factory default) and Enable.

## Ethernet Params

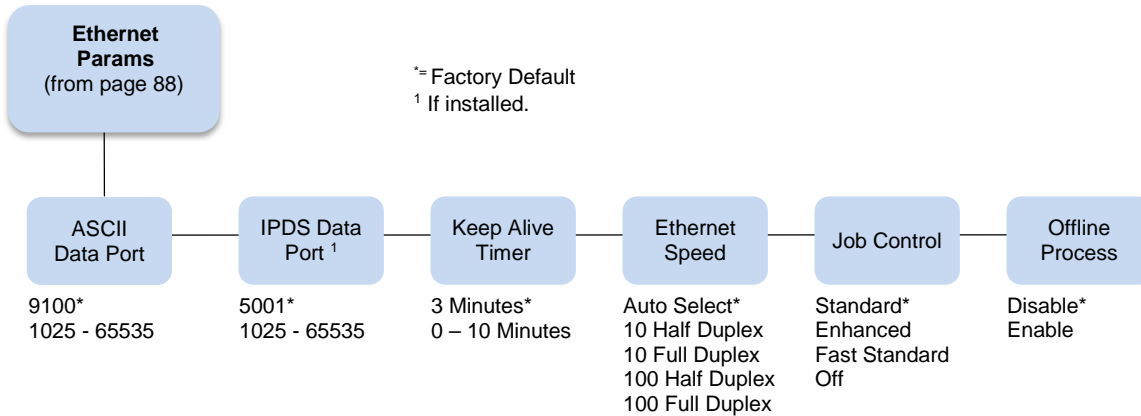

The Ethernet Params menu helps your printer communicate on a network.

For information on assigning the IP Address, Gateway Address, Subnet Mask, and MAC Address, refer to the *Network Interface Card User's Manual*.

### ASCII Data Port

This option sets the port number for ASCII print jobs. The data port number needs to match your host system setting.

- **9100** (factory default)
- **1025 - 65535**

### IPDS Data Port

This option allows you to set the port number for IPDS print jobs only if the IPDS option is installed.

- **5001** (factory default)
- **1025 - 65535**

### Keep Alive Timer

This is the time that the Keep Alive Timer will run. With the Keep Alive Timer on, the tcp connection will stay connected even after the print job has terminated.

- **3 Minutes** (factory default)
- **0 - 10 Minutes**



## Ethernet Speed

This menu option only appears if a 10/100Base-T network interface card (NIC) is installed. The Ethernet Speed menu allows compatibility with different systems and networks. The factory default is Auto Select.

- **Auto Select.** (factory default) This setting tells the 10/100Base-T NIC to perform an auto detection scheme and configure itself to be 10 Half Duplex, 10 Full Duplex, 100 Half Duplex, or 100 Full Duplex.
- **10 Half Duplex.** Tells the 10/100Base-T NIC to communicate at 10 Megabits per second using half duplex.
- **10 Full Duplex.** Tells the 10/100Base-T NIC to communicate at 10 Megabits per second using full duplex.
- **100 Half Duplex.** Tells the 10/100Base-T NIC to communicate at 100 Megabits per second using half duplex.
- **100 Full Duplex.** Tells the 10/100Base-T NIC to communicate at 100 Megabits per second using full duplex.

## Job Control

The job control mode has four options:

- **Standard** (factory default). The NIC waits for the printer to finish receiving the current job before sending another job. The status line shows “done” when the job is completely received by the NIC.
- **Enhanced.** The NIC waits for the printer to finish receiving the current job before sending another job. The status line shows “done” when the job is fully printed.
- **Off.** No job synchronization between the NIC and the printer.
- **Fast Standard.** The EOJ (End of Job) packet is acknowledged immediately. Use this selection if the job is timed out due to a delay in the acknowledgement of the EOJ packet because of the amount of data being printed.

**NOTE:** It is recommended to set this option to Enhanced if the emulation is Postscript.

## Offline Process

- **Disable** (factory default). When set to disable, the printer does not network data while in offline mode.
- **Enable.** When set to enable, the printer continues to process without printing the current network job while the printer is offline until the printer’s buffer is full.

# ACTIVE IGP EMUL and ACTIVE EMULATIONS

The emulation types present in the printer are based on the firmware installed and the emulation options included. Both are configured from the Factory and do not require any action from the user.

**IMPORTANT** Be sure to know which type of firmware and options are purchased (see Table 4) to understand the ACTIVE IGP EMUL, ACTIVE EMULATION, and EMULATION main menus. The H-Series and Indian Language printers only have the LinePrinter+ emulation.

This ACTIVE IGP EMUL and ACTIVE EMULATION function allows you to activate the desired emulation. There are two methods for selecting the desired emulation. The first is by selecting the emulation directly from the printer menu. The second is by sending a host command which will switch the emulation automatically (see the appropriate Programmer’s Reference Manual for details).

When changing from one emulation to the other, the printer will load the power-up configuration and the new emulation parameters. Any configuration settings performed before selecting these emulations that are not saved in NVRAM will be lost.

**Table 10 Available Firmware Types and Options**

<b>Firmware Type</b>	<b>ACTIVE IGP EMUL <sup>1</sup></b>	<b>ACTIVE EMULATION <sup>2</sup></b>	<b>EMULATION <sup>3</sup></b>
<b>P8000 Standard</b>	IGP/PGL*	N/A	IPDS, IPG/PGL LinePrinter+
	IGP/VGL	N/A	IPDS, IGP/VGL LinePrinter+
<b>P8000 TN</b>	IGP/PGL*	N/A	IGP/PGL LinePrinter+
	IGP/VGL	N/A	IGP/VGL LinePrinter+
<b>P8000 PCL-II</b>	N/A	PCL-II*	PCL-II
		IGP/PGL & LP+	IGP/PGL LinePrinter+
		IGP/VGL & LP+	IGP/VGL LinePrinter+
<b>P8000 LG</b>	N/A	LG*	LG
		IGP/PGL & LP+	IGP/PGL LinePrinter+
		IGP/VGL & LP+	IGP/VGL LinePrinter+
<b>P8000 ANSI</b>	N/A	44/48XX-ANSI*	44/48XX-ANSI
		IGP/PGL & LP+	IGP/PGL LinePrinter+
		IGP/VGL & LP+	IGP/VGL LinePrinter+
<b>OpenPrint P8000 Standard</b>	N/A	Postscript/PDF*	Postscript/PDF
		IGP/PGL & LP+	IGP/PGL LinePrinter+
		IGP/VGL & LP+	IGP/VGL LinePrinter+
<b>OpenPrint P8000 HD</b>	N/A	N/A	Postscript/PDF
<b>H-Series</b>	N/A	N/A	LinePrinter+
<b>Indian Language</b>	N/A	N/A	LinePrinter+
<b>Arabic Language</b>	N/A	N/A	LinePrinter+ ANALYZER

**NOTE:**

\* = Default Selection

<sup>1</sup> The Active IGP EMULATION menu is only available when the PGL/VGL option is installed.

<sup>2</sup> The ACTIVE EMULATION menu shows the options "IGP/PGL & LP+" and "IGP/VGL & LP+" when the PGL/VGL option is installed. Otherwise, "LinePrinter+" replaces the options.

<sup>3</sup> The selections under the EMULATION menu is based on the ACTIVE IGP EMULATION or ACTIVE EMULATION settings with all Optional Emulations installed.

# EMULATION Menu

The EMULATION menu allows you to configure the emulation used with your printer. The Proprinter XL, Epson FX, P-Series, P-Series XQ, and Serial Matrix emulations are all part of ASCII LinePrinter+. The H-Series LinePrinter+ has a unique set of emulations such as LQ1600K, KS, and KSSM depending on the firmware type. You can configure options for the active emulation via the EMULATION menu. Emulation options are further described in their corresponding Programmer's Reference Manual.

The menus shown for the ASCII LinePrinter+, IGP/PGL, and IGP/VGL are specific to the Standard, ANSI, and TN firmware. These emulations may be structured differently for the PCL-II and LG Firmware. For PCL-II and LG Firmware, some of the character sets or options may not be available.

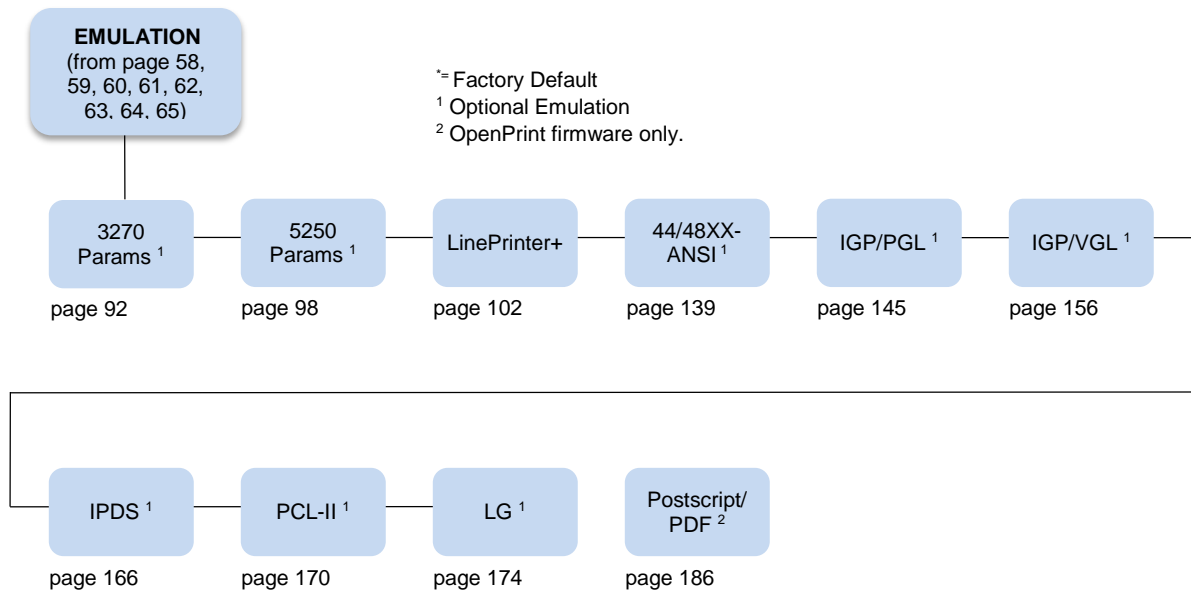

# 3270 Params

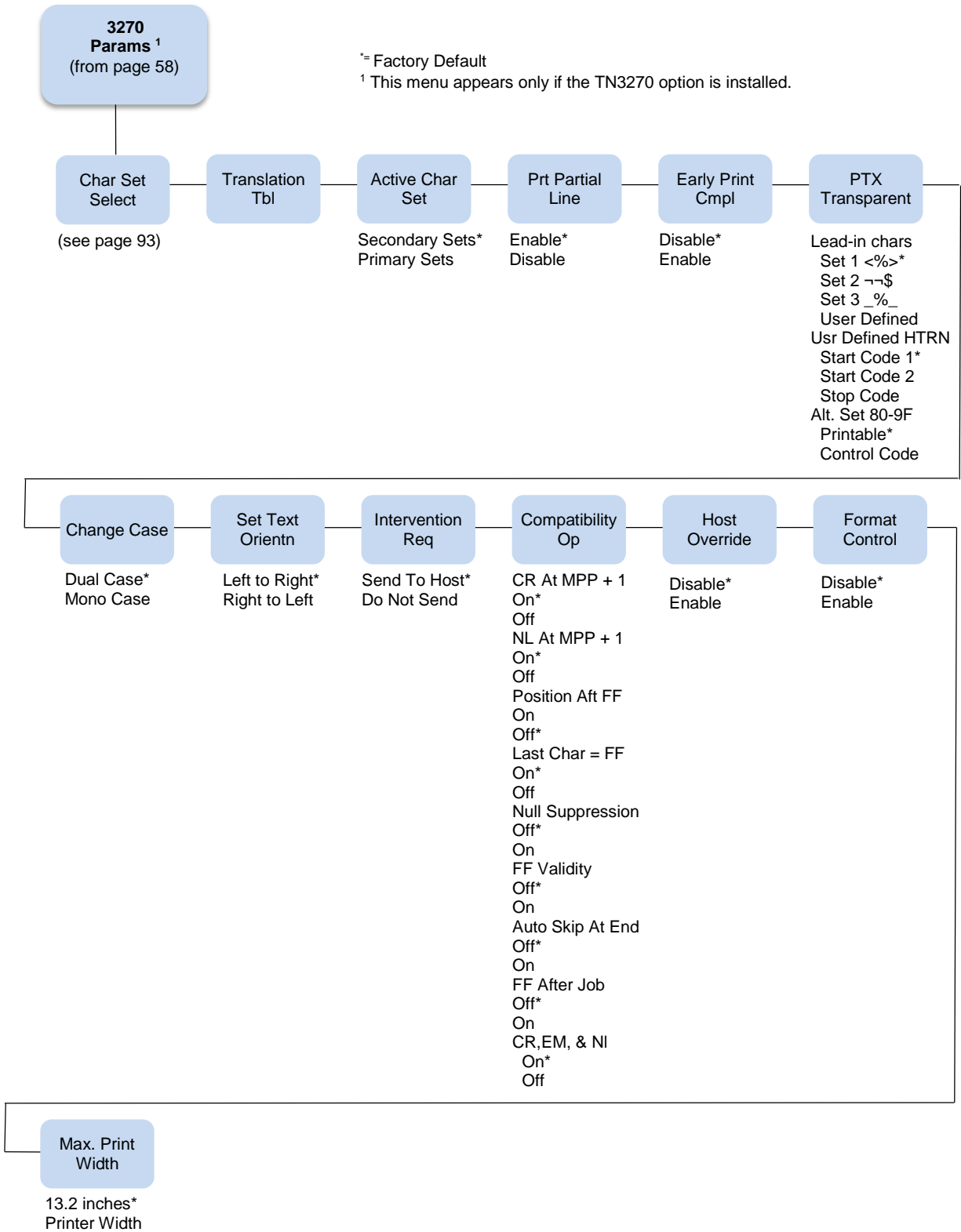

**3270  
Params**

Char Set Select  
(from page 92)

Primary Sets

Secondary Sets

\*= Factory Default

- 0037 English US\*
- 0037 Eng Nether
- 0285 English UK
- 0273 Austr/Germ
- 0274 Belg. Old
- 0275 Brazilian
- 0260 Canad Fren
- 0277 Danish
- 0287 Danish Alt
- 0278 Finnish
- 0288 Finn. Alt
- 0297 French
- 0500 Internat 5
- 0280 Italian
- 0281 Japan. Eng
- 0282 Portuguese
- 0284 Span Speak
- 0289 Span. Alt
- 0500 Swiss Bil
- 0500 Belg. New
- 0803 Hebrew Old
- 0424 Hebrew
- 0892 ORC A
- 0893 ORC B
- 0420 Arabic
- 0880 Cyril. Old
- 0423 Greek Old
- 0875 Gr New Euro
- 0871 Icelandic
- 0290 Japan Katak
- 0870 Latin 2
- 0838 Thai
- 1026 Turkish
- 0890 Yugos. Old
- 1097 Farsi
- 1025 Cyrillic
- 0905 Turk. Old
- 0256 Intern. 1
- 0924 Euro Lat-9
- 1140 Euro Eng.
- 1141 Euro Aust.
- 1142 Euro Dan.
- 1143 Euro Finn.
- 1144 Euro Ital.
- 1145 Euro Span.
- 1146 Euro UK
- 1147 Euro Fren.
- 1148 Euro Swiss
- 1149 Euro Ice.

- English US\*
- English UK
- Austrian/German
- German (Alt.)
- Belgian
- Brazilian
- Canadian French
- Danish/Norweg.
- Danish (Alt)
- Finnish/Swedish
- Finnish (Alt)
- French
- International
- Italian
- Japanese Eng.
- Japanese Katak.
- Portuguese
- Portug. (Alt)
- Spanish
- Spanish (Alt)
- Spanish Speak.
- Swiss Fren/Ger
- Old Hebrew
- Hebrew
- Farsi/Latin
- Greek Old
- Greek New
- Arabic
- Turkish
- Turkish Old
- Latin 2/ROECE
- Yugoslavian

## Translation Tbl

Prints out a table of the Coax interface's current character set. This operation is valid only when the TN3270 interface is the current interface.

## Active Char Set

Specifies which character language set will be the active set.

- **Secondary Sets** (factory default)
- **Primary Sets**

## Prt Partial Line

- **Enable** (factory default). When this option is enabled, it forces the printer to print if a partial line is in the printer (i.e. line not ending with a LF).
- **Disable**. When disabled, the last partial line of data will not be printed.

## Early Print Cmpl

Early Print Complete allows the printer to send Print Complete status to the host before the printer is actually done printing all data. Early Print Complete is only available if the IPDS feature is installed.

- **Disable** (factory default). Means the printer will suppress the Early Print Complete response until all printing is complete.
- **Enable**. Means the printer will send an acknowledgement to the host when it is able to accept more data.

**NOTE:** When an Early Print Complete is enabled and an error occurs, the data in the printer will remain in the buffer (regardless of the setting of the Cancel Buffer option). It is recommended that local procedures be followed to recover from the error.

Do not select Early Print Complete while a print job is in progress. If this is done you will need to restart the printer.

## PTX Transparent

### Lead-in Chars

You can enable additional printer features which are not accessible through standard TN3270 emulations. To access these features, send text commands in the data stream. The commands must have a start and end code. Four sets are available:

- **Set 1.** start code: <% (factory default)  
stop code: >
- **Set 2.** start code: ──  
stop code: \$
- **Set 3.** start code: \_%  
stop code: \_
- **User Defined.**

## Usr Defined HTRN

This option is used to set user defined lead-in characters. The range is ASCII character. This option allows users to define their own lead-in characters for the Printronix Specific commands. Select a hex value for the following codes for the User Defined option:

- **Start Code 1 5F** (factory default)
- **Start Code 2 5F**
- **Stop Code 5B**

## Alt. Set 80-9F

- **Printable** (factory default). Prints data in the range of hex 80 through hex 9F.
- **Control Code**. Interprets data in the range of hex 80 through hex 9F as a control code.

## Change Case

Specifies the font as Mono or Dual case. This option is available only in non- SCS mode. The host will be notified of the change when the printer is placed online. Mono Case prints the same as Dual Case if the character set is one of the following “right to left” sets: Katak., Hebrew, Old Hebrew, and Farsi.

SCS (System Network Architecture Character String) mode is controlled by the host computer.

- **Dual Case** (factory default)
- **Mono Case**

## Set Text Orientn

Specifies the direction in which characters are printed on the page. This allows the printer to print languages which are printed right to left instead of left to right.

- **Left to Right** (factory default).
- **Right to Left**. When a right to left language is selected, the host will be notified of print direction changes when the printer is put online.

## Intervention Req

Select from the following:

- **Send To Host** (factory default). The printer sends a signal to the host computer when any of the following occur:
  - Printer faults occur.
  - Hold mode time-out occurs.
- **Not Send To Host**

If not selected, the printer will only send the signal on printer faults that cause data loss (paper jam, ribbon stall, online platen open, etc.).

## Compatibility Op

The Compatibility Options allow you to select special printer functions in the non-SCS mode based on the capabilities of the printer emulated.

### **CR At MPP+1**

MPP is Maximum Print Position, which is also known as line length. This option controls a carriage return at the end of a print line and at MPP+1.

- **On** (factory default). Produces a carriage return to the first print position of the next line.
- **Off**. Produces a carriage return to the first print position of the current line.

### **NL At MPP+1**

Controls how many lines are skipped when the carriage returns to a new line.

- **On** (factory default). Moves to the first print position two lines down from the current position.
- **Off**. Moves to the first print position of the next print line.

### **Position Aft FF (4234 only)**

Allows you to select the location of the print position after a form feed command is sent.

- **On**. Sets the printer to print at print position 1 of the first print line on the next form.
- **Off** (factory default). Sets the printer to print at print position 2 of the first print line on the next form.

### **Last Char = FF**

Determines the print line position when a form feed command is the last code encountered in the print buffer.

- **On** (factory default). Moves to the first print position on the second line of the next form.
- **Off**. Moves to the first print position on the first line of the next form.

**NOTE:** This option is ignored if Auto Skip At End is on.

If configured as a 3287, and a form feed occurs in the middle of a print buffer, the printer defaults to the first print position on the second line of the next form regardless of the setting of this option.

### **Null Suppression**

- **Off** (factory default). Ignores nulls. The print position does not move.
- **On**. Treats nulls as blank spaces.

### **FF Validity**

Determines if the position of a form feed command affects its execution.

- **Off** (factory default). Performs a form feed only if it occurs at the first print position in a line or at Maximum Print Position +1. A form feed command at any other position is recognized as a space.
- **On**. Allows the printer to perform a form feed command anywhere in the data stream.

### **Auto Skip At End**

Specifies whether or not to perform an automatic form feed at the end of a print buffer. If form feed is the last character in the print order, the form feed function is supplied by the Auto Skip At End option.

- **Off** (factory default). Sets the printer to print at print position 1 of the next line.
- **On**. Sets the printer to print at print position 1 of the first line of the next form.



### **FF After Job**

Determines the print position after an operator-initiated local copy (print screen function).

- **Off** (factory default). Performs an automatic new line command after completing a print buffer (unless a new line, form feed, or carriage return command was the last one executed). The printer is set to print at print position 1 of the next line.
- **On**. Performs an automatic form feed command unless a form feed was the last one executed. The printer is set to print at print position 1 of the first line on the next form.

### **CR, EM, and NL (3287 only)**

CR (Carriage Return), EM (Error Message), and NL (New Line) specify that the printer treat the CR, EM, and NL control codes either as spaces or as control codes.

- **On** (factory default). Treats the CR, EM, and NL commands as control codes.
- **Off**. Treats the CR, EM, and NL commands as spaces.

### **Host Override**

Determines whether the printer accepts certain commands sent by the host, or continues to use the current operator panel settings.

- **Disable** (factory default). Allows these host commands to override operator panel settings: line length, forms length, lines per inch (LPI), characters per inch (CPI), print quality, and text orientation. Note the information appearing on the message display may not match the data stream setting. No values will change upon initial selection of the disable option.
- **Enable**. The operator panel settings override the host commands.

### **Format Control**

Enables the printer to reflect the same spacing as CTPC model printers after absolute and relative move commands are executed.

- **Disable** (factory default). Reflects distance, generated by the VGL feature, PGL feature, and Hex Transparent control code sequence, in the new position (after horizontal and vertical tabs are executed).
- **Enable**.

### **Max. Print Width**

Set the maximum print width the printer will print when using a C/T host interface. Set for 13.2 inches when printing files larger than the width of the printer. All data exceeding the width of the maximum Printer Width will be truncated.

- **13.2 inches** (factory default)
- **Printer Width** (the maximum width of the printer)

# 5250 Params

**5250 Params**<sup>1</sup>  
(from page 58)

\*= Factory Default

<sup>1</sup> This menu appears only if the TN5250 option is installed.

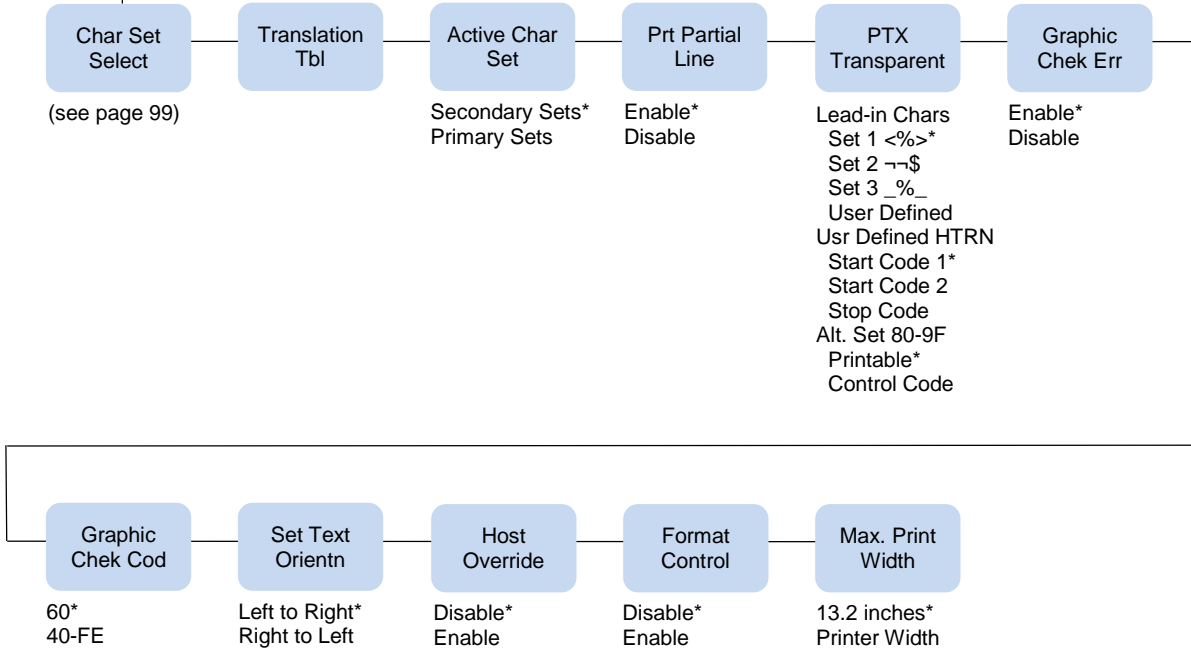

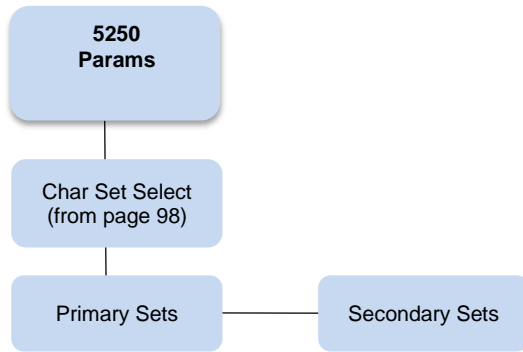

\*= Factory Default

0037 English US\*  
 0037 Eng Nether  
 0500 Swiss Bil  
 0500 Belg. New  
 0273 Austr/Germ  
 0274 Belg. Old  
 0275 Brazilian  
 0260 Canad Fren  
 0277 Danish  
 0278 Finnish  
 0297 French  
 0280 Italian  
 0281 Japan. Eng  
 0282 Portuguese  
 0284 Span Speak  
 0285 English UK  
 0892 ORC A  
 0893 ORC B  
 0424 Hebrew  
 0803 Hebrew Old  
 0420 Arabic  
 0880 Cyril. Old  
 0423 Greek Old  
 0875 Gr New Euro  
 0871 Icelandic  
 0290 Japan Kata  
 0870 Latin 2  
 0838 Thai  
 1026 Turkish  
 0890 Yugos. Old  
 1097 Farsi  
 1025 Cyrillic  
 0256 Intern. 1  
 1112 Balt Mult  
 0924 Euro Lat-9  
 1122 Estonian  
 1140 Euro Eng.  
 1141 Euro Aust.  
 1142 Euro Dan.  
 1143 Euro Finn.  
 1144 Euro Ital.  
 1145 Euro Span.  
 1146 Euro UK  
 1147 Euro Fren.  
 1148 Euro Swiss  
 1149 Euro Ice.  
 0500 Internat 5

English US\*  
 Austrian/German  
 Belgian  
 Brazilian  
 Canadian French  
 Danish/Norweg.  
 Finnish/Swedish  
 French  
 Italian  
 Japanese Eng.  
 Japanese Katak.  
 Portuguese  
 Spanish  
 Spanish Speak.  
 English UK  
 Old Hebrew  
 Hebrew  
 Farsi/Latin  
 Greek Old  
 Greek New  
 Arabic  
 Turkish  
 Latin 2/ROECE  
 Yugoslavian  
 Multinational

## Translation Tbl

Prints out a table of the TN5250 interface's current character set. This operation is valid only when the TN5250 interface is the current interface.

## Active Char Set

Selects which group of character sets (Primary or Secondary) will be active.

- **Secondary Set** (factory default)
- **Primary Set**

## Prt Partial Line

- **Enable** (factory default). When this option is enabled, it forces the printer to print if a partial line is in the printer (i.e. line not ending with a LF).
- **Disable**. When disabled, the last partial line of data will not be printed.

## PTX Transparent

### Lead-in Chars

You can enable additional printer features which are not accessible through standard TN5250 emulations. To access these features, send text commands in the data stream. The commands must have a start and end code. Four sets are available:

- **Set 1**. start code: <% (factory default)  
stop code: >
- **Set 2**. start code: ↯↯  
stop code: \$
- **Set 3**. start code: \_%  
stop code: \_
- **User Defined**.

### Usr Defined HTRN

This option is used to set user defined lead-in characters. The range is ASCII character. This option allows users to define their own lead-in characters for the Printronix Specific commands. Select a hex value for the following codes for the User Defined option:

- **Start Code 1 5F** (factory default)
- **Start Code 2 5F**
- **Stop Code 5B**

### Alt. Set 80-9F

- **Printable** (factory default). Prints data in the range of hex 80 through hex 9F.
- **Control Code**. Interprets data in the range of hex 80 through hex 9F as a control code.

### Graphic Chk Err

Allows overriding of the host setting for the SGEA (Set Graphic Error Action) command.

- **Enable** (factory default). The host setting for the SGEA used by the printer. If the SGEA command is requested to stop on graphic errors, the printer will stop when a graphic error is detected.

- **Disable.** Ignores the SGEA command from the host. The printer does not stop when an error is detected; instead, it substitutes the character selected in the Graphic Chek Code parameter.

### Graphic Chek Cod

Specifies the replacement character to print in place of any unprintable character that is received from the host. Choose a hex character from 40 through FE. The character becomes the printer default when:

- The printer is powered off and then powered on.
- An SGEA command specifies to use the operator panel default.
- The Graphic Chek Err parameter is disabled.

The value can be the following:

- **60** (factory default)
- **40 – F4**

### Set Text Orientn

Specifies the direction in which characters are printed on the page. This allows the printer to print languages which are printed right to left instead of left to right.

- **Left to Right** (factory default)
- **Right to Left.** When a right to left language is selected, the host will be notified of print direction changes when the printer is put online.

### Host Override

Determines whether the printer accepts certain commands sent by the host, or continues to use the current operator panel settings.

- **Disable** (factory default). Allows these host commands to override operator panel settings: line length, forms length, lines per inch (LPI), characters per inch (CPI), print quality, and text orientation. Note the information appearing on the message display may not match the data stream setting. No values will change upon initial selection of the disable option.
- **Enable.** The operator panel settings override the host commands.

### Format Control

Enables the printer to reflect the same spacing as earlier generation line matrix printers after absolute and relative move commands are executed.

- **Disable** (factory default). Reflects distance, generated by the VGL feature, PGL feature, and Hex Transparent control code sequence, in the new position (after horizontal and vertical tabs are executed).
- **Enable.**

### Max. Print Width

Set the maximum print width the printer will print when using an IBM host interface. Set for 13.2 inches when printing files larger than the width of the printer. All data exceeding the width of the maximum Printer Width will be truncated.

- **13.2 Inches** (factory default)
- **Printer Width** (the maximum width of the printer)

# LinePrinter Plus Emulation (ASCII, Indian Language)

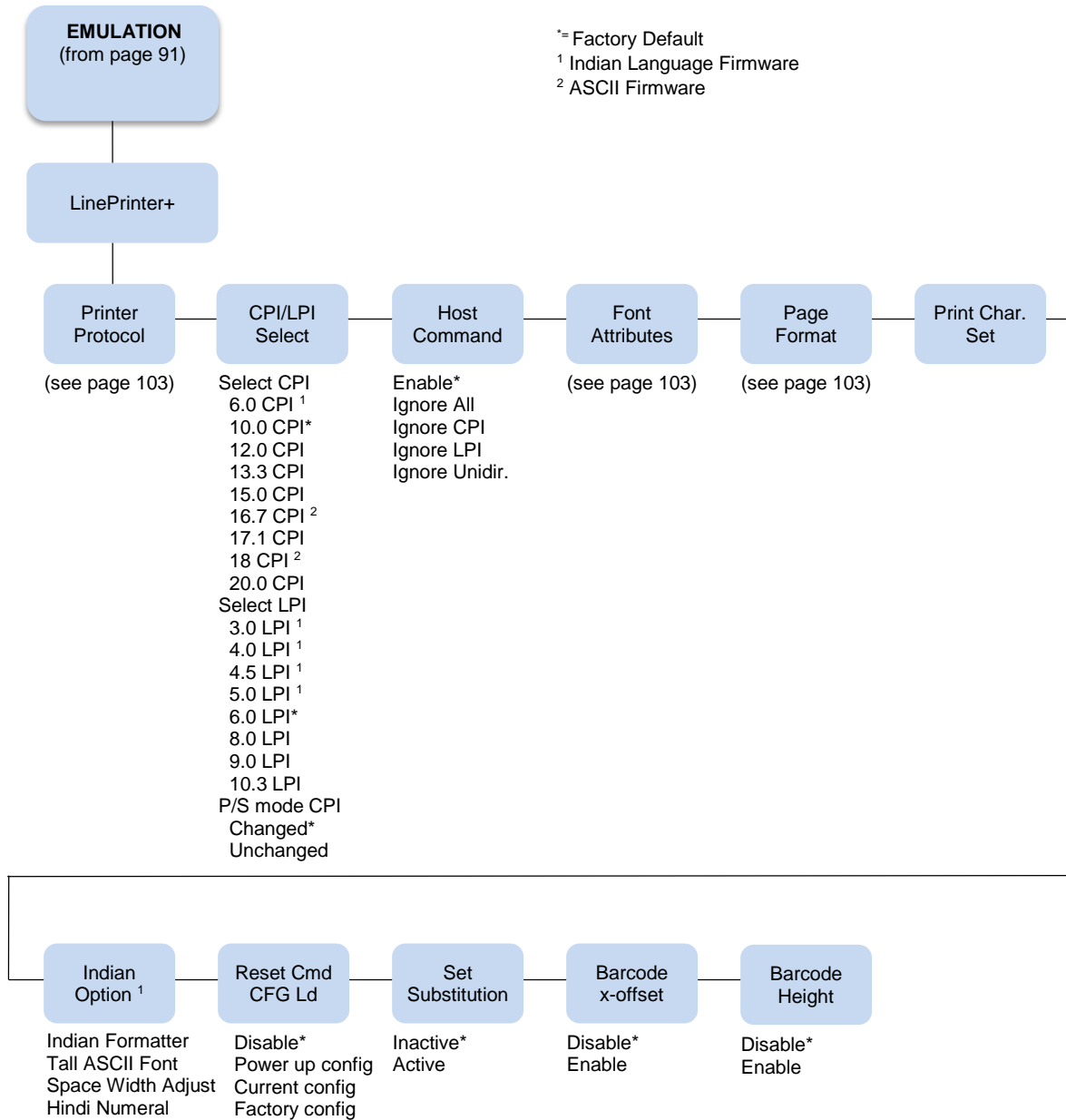

\*= Factory Default

<sup>1</sup> Hidden when IPDS is active.

<sup>2</sup> Indian Language Firmware

<sup>3</sup> Arabic Language Firmware

**Printer Protocol**  
(from page 102)

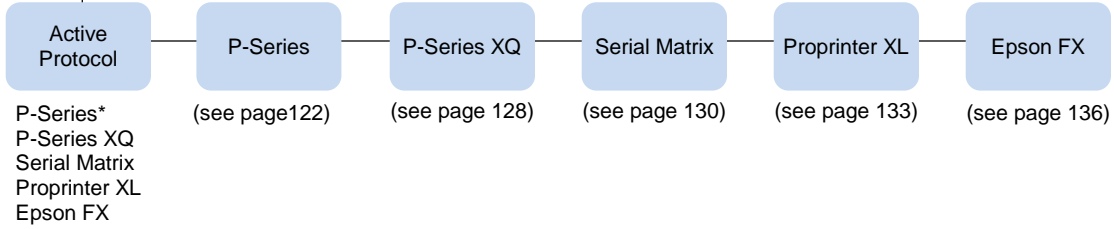

**Font Attributes**  
(from page 102)

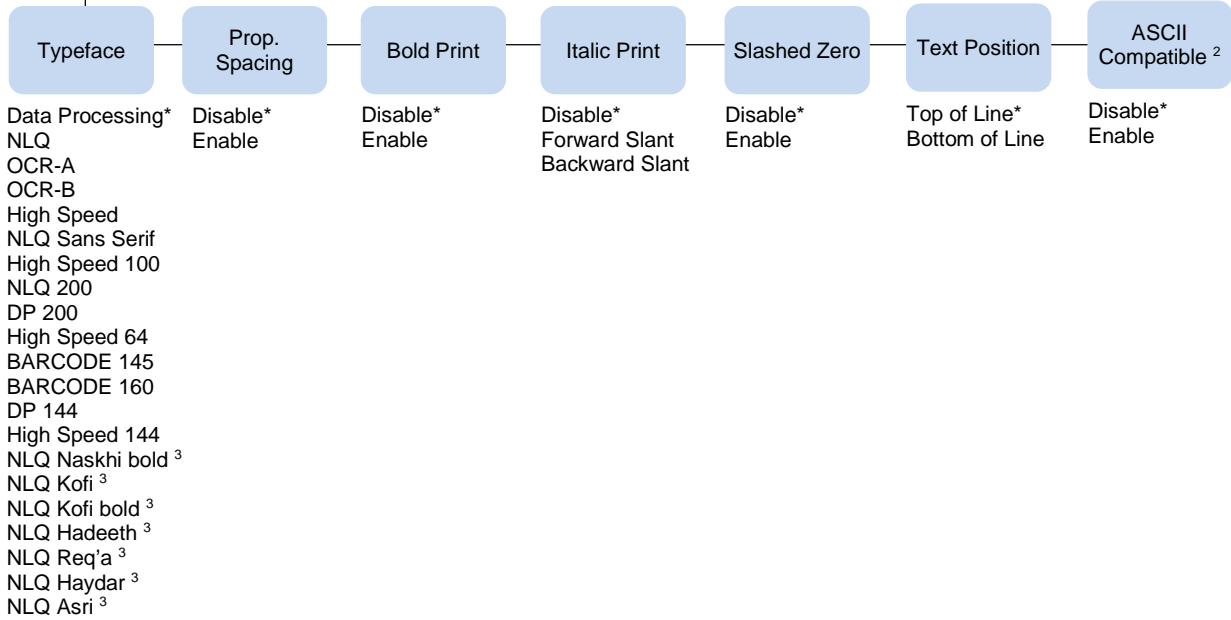

**Page Format**  
(from page 102)

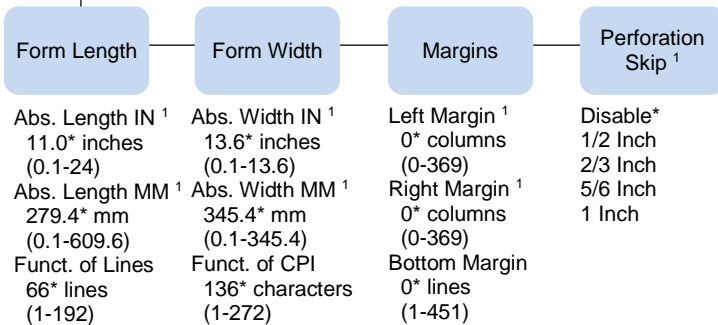

# LinePrinter Plus Emulation (H-Series Hanzi GB)

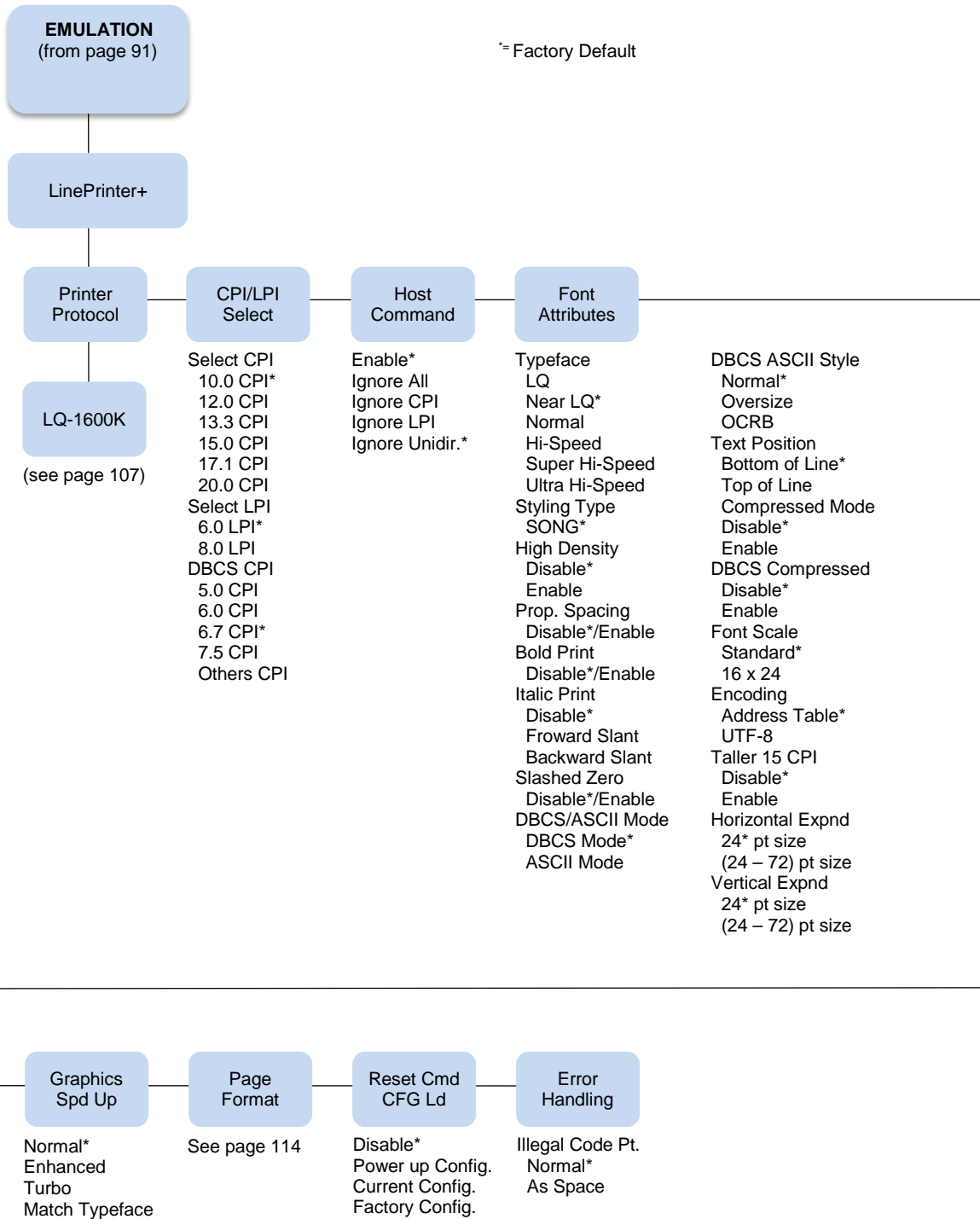



# LinePrinter Plus Emulation (H-Series Hanzi Big5)

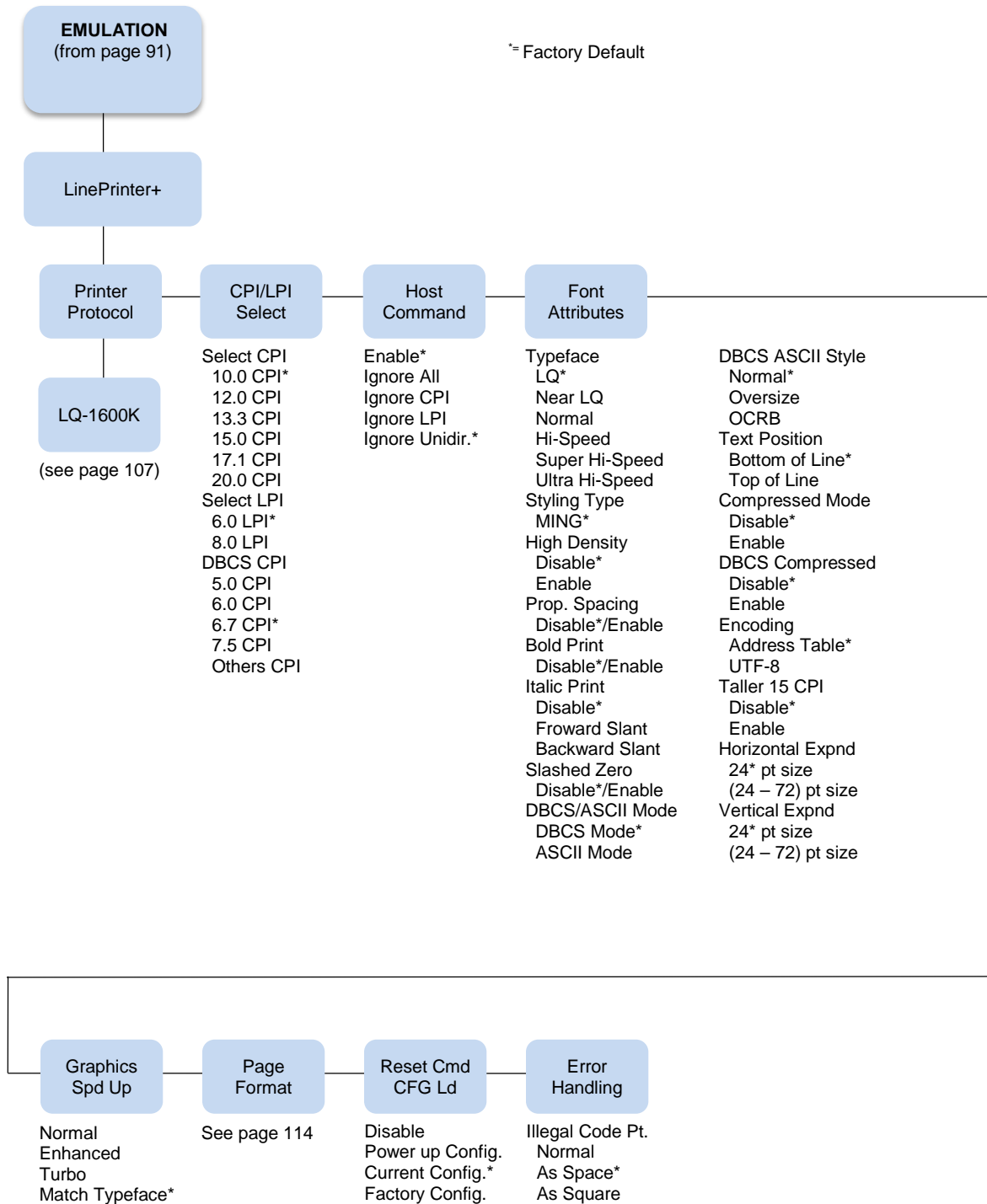

# LinePrinter Plus Emulation (H-Series Kanji)

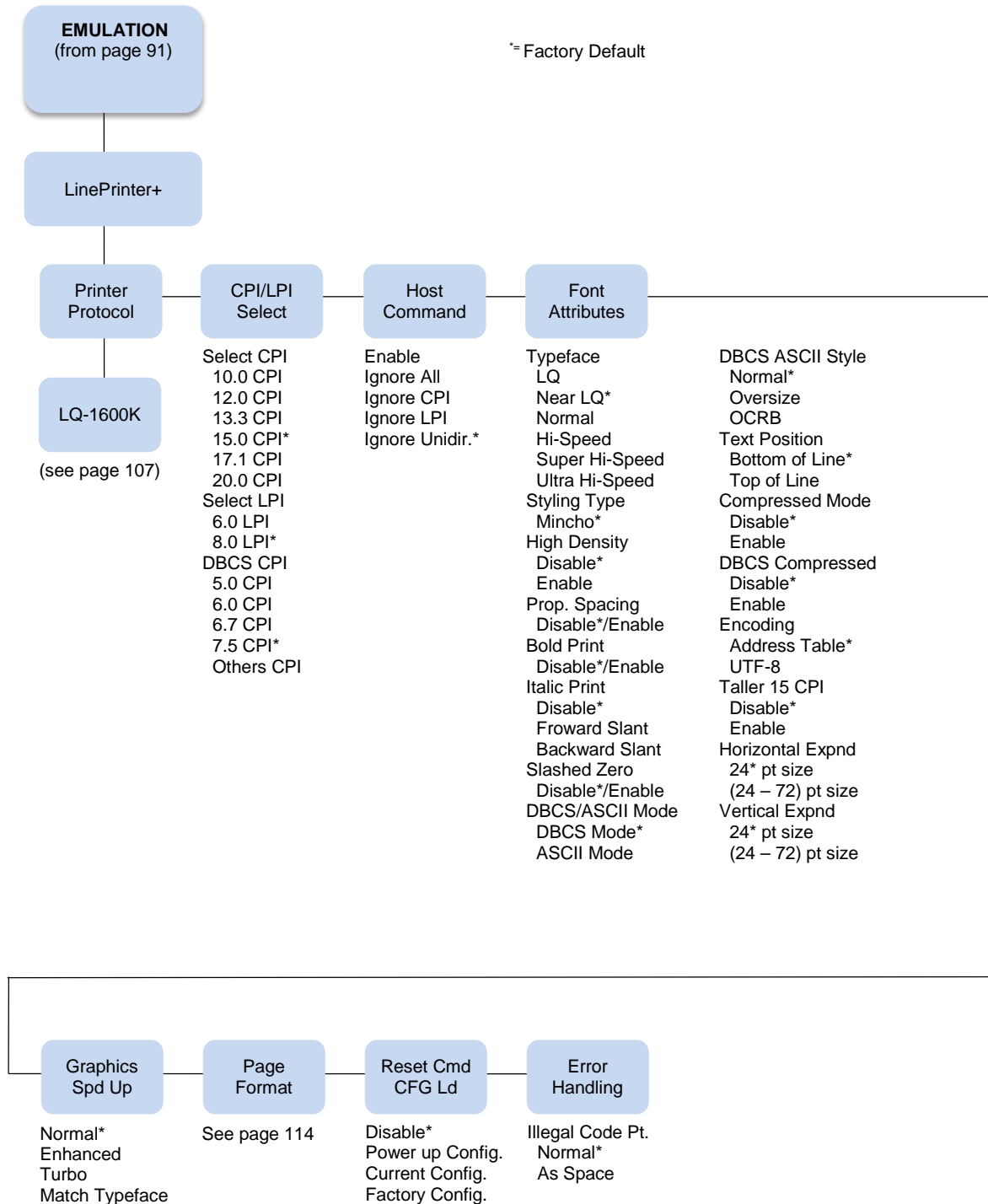

# LQ-1600K Emulation

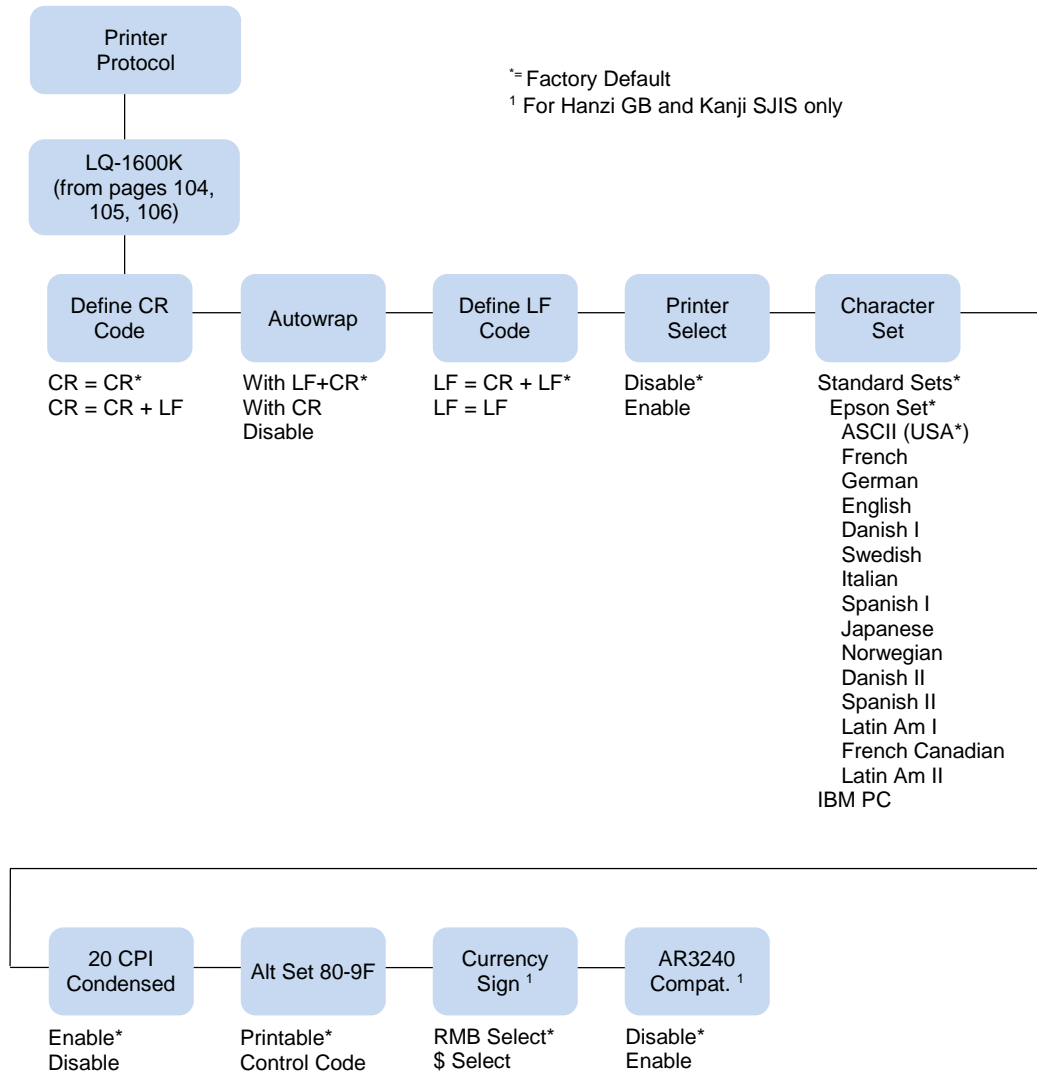

### Define CR Code

The Define CR Code option controls the action of the printer when it receives a Carriage Return code (hex 0D) from the host computer. If this feature is enabled, each time the printer receives a Carriage Return, it inserts an additional Line Feed code (hex 0A) into the data stream. Do not use this feature if the host computer sends Line Feeds to the printer.

- **CR = CR** (factory default). Does not insert an extra Line Feed after each Carriage Return.
- **CR = CR + LF**. Inserts an extra Line Feed after each Carriage Return.

### Autowrap

This option defines the printer actions when print data is received past the forms width setting.

- **With LF+CR** (factory default). Performs an automatic carriage return and line feed when data is received past the forms width.
- **With CR**. Performs an automatic carriage return (without line feed) when data is received past the forms width.
- **Disable**. Discards any data past the forms width.

### Define LF Code

The Define LF Code option controls the action of the printer when it receives a Line Feed code (hex 0A) from the host computer. If this feature is enabled, each time the printer receives a Line Feed, it inserts an additional Carriage Return code (hex 0D) into the data stream. This feature can be used in most installations, but it is required if the host computer does not send Carriage Returns to the printer.

- **LF = CR + LF** (factory default). Adds an extra Carriage Return with each Line Feed.
- **LF = LF**. Does not add a Carriage Return with a Line Feed.

### Printer Select

- **Disable** (factory default). Ignores the ASCII DC1 and DC3 control codes.
- **Enable**. Disables the printer when a DC1 control code is received, and enables the printer when a DC3 control code is received.

### Character Set

This parameter selects a character set for the Epson® emulation.

### 20 CPI Condensed

Compressed print characters are narrower than the normal character set. This is helpful for applications for which you need to print the maximum amount of information on a page.

- **Enable** (factory default). Prints about 60 percent of the width of normal characters when compressed print is chosen by the host computer. For example, a 12 CPI Draft font will compress to 20 CPI.
- **Disable**. Does not compress print widths, even if condensed print is chosen by the host.

### Alt. Set 80-9F

- **Control Code** (factory default). Interprets data in the range of hex 80 through hex 9F as a control code.
- **Printable**. Prints data in the range of hex 80 through hex 9F.

### **Currency Sign (for GB and Kanji)**

- **RMB Select** (factory default). The ASCII code hex 24 is printed as a RMB “¥” character in DBCS mode. Default for GB.
- **\$ Select**. The ASCII code hex 24 is printed as a dollar “\$” character in DBCS mode. Default for Kanji.

### **AR3240 (for GB and Kanji)**

- **Disable** (factory default). AR3240 emulation does not take effect. Default.
- **Enable**. AR3240 takes effect, SUB (0x1A) is used as another SFCC. The listed commands will take effect and turn the extending table character on.

# LinePrinter Plus Emulation (H-Series Hangul)

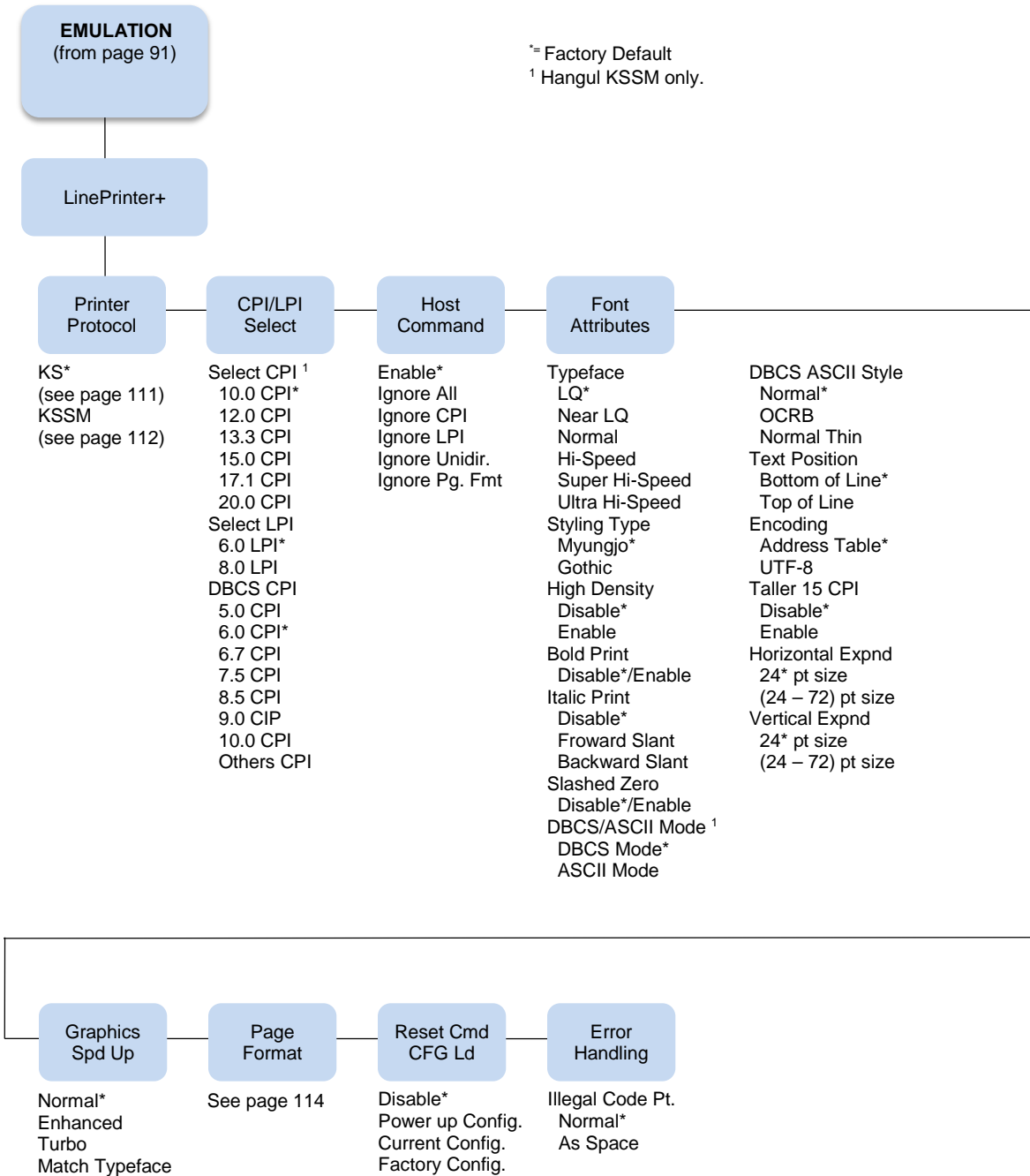

## KS Emulation

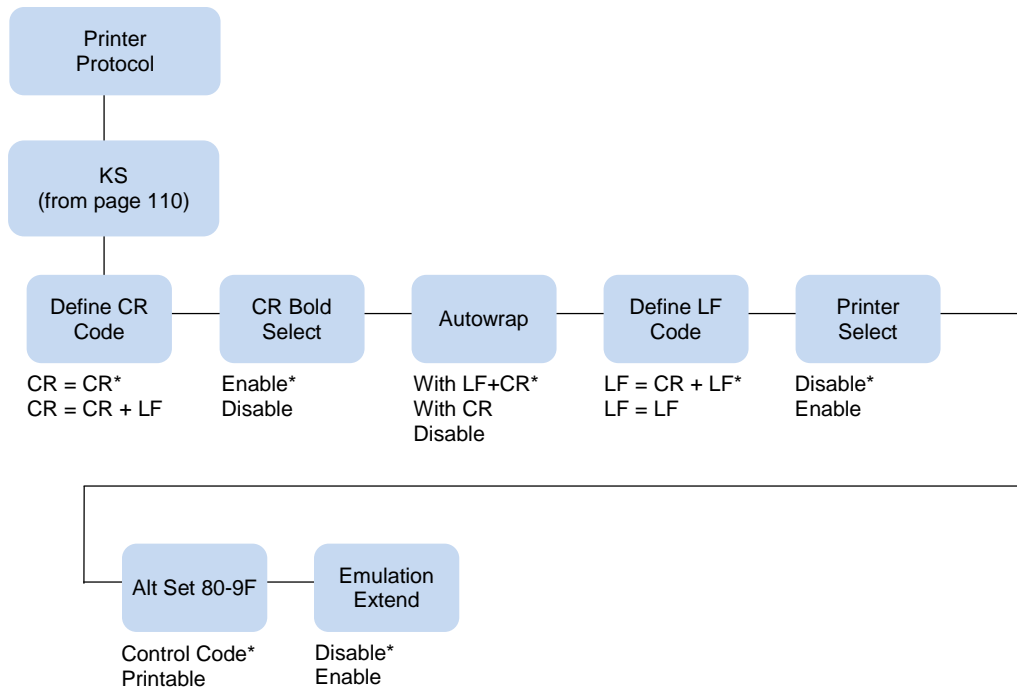

### Define CR Code

The Define CR code option controls the action of the printer when it receives a Carriage Return code (hex 0D) from the host computer. If this feature is enabled, each time the printer receives a Carriage Return, it inserts an additional Line Feed code (hex 0A) into the data stream. Do not use this feature if the host computer sends Line Feeds to the printer.

- **CR = CR** (factory default). Does not insert an extra Line Feed after each Carriage Return.
- **CR = CR + LF**. Inserts an extra Line Feed after each Carriage Return.

### CR Bold Select

This option determines whether CR (0x0D) will turn on the bold attribute.

- **Enable** (factory default). The text after CR will be printed as bold together with the text before CR.
- **Disable**. Normal CR function.

### Autowrap

This option defines the printer actions when print data is received past the forms width setting.

- **With LF+CR** (factory default). Performs an automatic carriage return and line feed when data is received past the forms width.
- **With CR**. Performs an automatic carriage return (without line feed) when data is received past the forms width.
- **Disable**. Discards any data past the forms width.

## Define LF Code

The Define LF code option controls the action of the printer when it receives a Line Feed code (hex 0A) from the host computer. If this feature is enabled, each time the printer receives a Line Feed, it inserts an additional Carriage Return code (hex 0D) into the data stream. This feature can be used in most installations, but it is required if the host computer does not send Carriage Returns to the printer.

- **LF = CR + LF** (factory default). Adds an extra Carriage Return with each Line Feed.
- **LF = LF**. Does not add a Carriage Return with a Line Feed.

## Printer Select

- **Disable** (factory default). Ignores the ASCII DC1 and DC3 control codes.
- **Enable**. Disables the printer when a DC1 control code is received, and enables the printer when a DC3 control code is received.

## Alt. Set 80-9F

- **Control Code** (factory default). Interprets data in the range of hex 80 through hex 9F as a control code.
- **Printable**. Prints data in the range of hex 80 through hex 9F.

## Emulation Extend

- **Disable** (factory default). Does not select the extension command.
- **Enable**. Selects the extension command (ESC 4/ESC 5 to select/cancel Italic Printing and ESC SP to select Intercharacter Spacing).

## KSSM Emulation

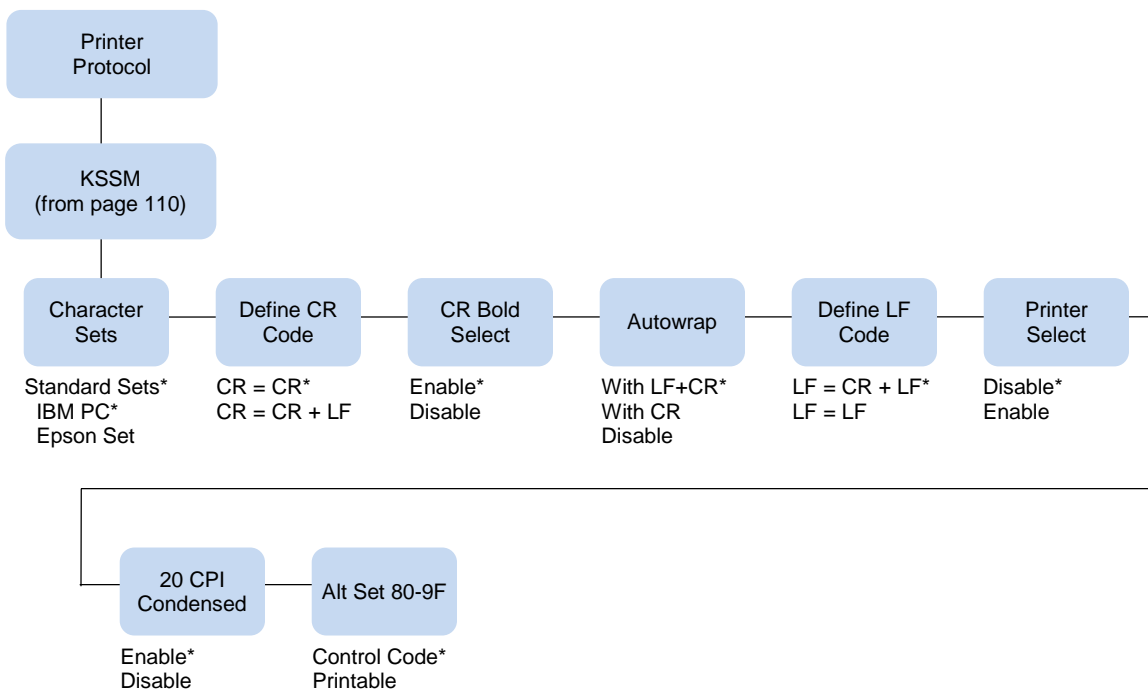



## Character Sets

This parameter selects a character set for the KSSM emulation.

## CR Bold Select

This option determines whether CR (0x0D) will turn on the bold attribute.

- **Enable** (factory default). The text after CR will be printed as bold together with the text before CR.
- **Disable**. Normal CR function.

## Define CR Code

The Define CR code option controls the action of the printer when it receives a Carriage Return code (hex 0D) from the host computer. If this feature is enabled, each time the printer receives a Carriage Return, it inserts an additional Line Feed code (hex 0A) into the data stream. Do not use this feature if the host computer sends Line Feeds to the printer.

- **CR = CR** (factory default). Does not insert an extra Line Feed after each Carriage Return.
- **CR = CR + LF**. Inserts an extra Line Feed after each Carriage Return.

## Autowrap

This option defines the printer actions when print data is received past the forms width setting.

- **With LF+CR** (factory default). Performs an automatic carriage return and line feed when data is received past the forms width.
- **With CR**. Performs an automatic carriage return (without line feed) when data is received past the forms width.
- **Disable**. Discards any data past the forms width.

## Define LF Code

The Define LF code option controls the action of the printer when it receives a Line Feed code (hex 0A) from the host computer. If this feature is enabled, each time the printer receives a Line Feed, it inserts an additional Carriage Return code (hex 0D) into the data stream. This feature can be used in most installations, but it is required if the host computer does not send Carriage Returns to the printer.

- **LF = CR + LF** (factory default). Adds an extra Carriage Return with each Line Feed.
- **LF = LF**. Does not add a Carriage Return with a Line Feed.

## Printer Select

- **Disable** (factory default). Ignores the ASCII DC1 and DC3 control codes.
- **Enable**. Disables the printer when a DC1 control code is received, and enables the printer when a DC3 control code is received.

## 20 CPI Condensed

Compressed print characters are narrower than the normal character set. This is helpful for applications for which you need to print the maximum amount of information on a page.

- **Enable** (factory default). Prints about 60 percent of the width of normal characters when compressed print is chosen by the host computer. For example, a 12 cpi font will compress to 20 cpi.
- **Disable**. Does not compress print widths, even if condensed print is chosen by the host.

## Alt. Set 80-9F

- **Control Code** (factory default). Interprets data in the range of hex 80 through hex 9F as a control code.
- **Printable**. Prints data in the range of hex 80 through hex 9F.

## Page Format Submenu (H-Series)

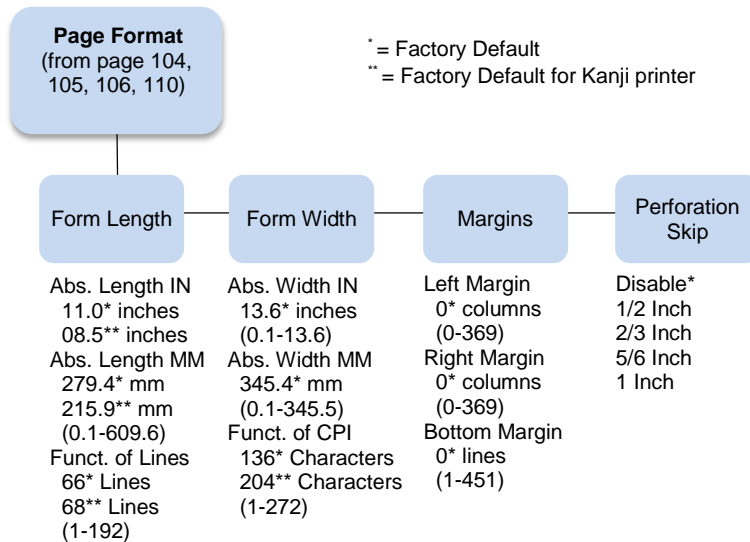

## Printer Protocol

Select the LinePrinter+ protocol you wish to use. Refer to the *LinePrinter Plus Programmer's Reference Manual* for more information with ASCII products.

For H-Series Hanzi GB, Hanzi Big5, or Kanji LP+ printers, refer to the *LQ-1600K Programmer's Reference Manual* for details. For the H-Series Hangul LP+ printer, refer to the *KS or KSSM Programmer's Reference Manual* for details.

## CPI/LPI Select

This parameter lets you specify the characters per inch (cpi) and lines per inch (lpi) values.

## Host Command

This parameter allows you to block certain host commands from being acknowledged by the printer.

- **Enable** (factory default). All host commands are acknowledged by the printer.
- **Ignore All**. All host commands are ignored by the printer.
- **Ignore CPI**. All CPI commands sent by the host are ignored by the printer.
- **Ignore LPI**. All LPI commands sent by the host are ignored by the printer.
- **Ignore Unidir**. All Unidirectional commands sent by the host are ignored by the printer.
- **Ignore Pg. Fmt**. All page format commands sent by the host are ignored by the printer. This is applicable for H-Series Hangul LP+ printers only.

## Font Attributes

### Typeface (ASCII)

**NOTE:** Not all firmware types have the entire list of typefaces.

- **Data Processing** (factory default). A general purpose font printing out at 120 dpi horizontally and 72 dpi vertically. The width of the font will vary with each cpi. For Indian Language firmware, the Indian character sets must be selected for Indian characters to print.
- **NLQ**. A high quality font printing at 180 dpi horizontally and 96 dpi vertically. This font has serifs and the width of the font varies with the cpi. For Indian Language firmware, the Indian character sets must be selected for Indian characters to print.
- **OCR-A / OCR-B**. Optical character recognition fonts printing at 120 dpi horizontally and 144 dpi vertically. Both fonts print only at 10 cpi.
- **High Speed**. A draft quality font printing at 120 dpi horizontally and 48 dpi vertically. The width of the font varies with the cpi.
- **NLQ Sans Serif**. A high quality font printing at 180 dpi horizontally and 96 dpi vertically. This font prints without serifs. The width of the font varies with the cpi.
- **High Speed 100**. A draft quality font printing at 100 dpi horizontally and 48 dpi vertically. When chosen from the front panel, it defaults to 10 cpi. The cpi can then be varied, but the width will not change.
- **NLQ 200**. This NLQ font prints at 200 dpi horizontally and 96 vertically. When chosen from the front panel, it defaults to 12 cpi. The cpi can then be varied, but the width will not change.
- **DP 200**. This Data Processing font prints at 200 dpi horizontally and 72 vertically. When chosen from the front panel, it defaults to 12 cpi. The cpi can then be varied, but the width will not change.
- **High Speed 64**. This font prints at 120 dpi horizontally and 64 vertically. When chosen from the front panel, it defaults to 10 cpi. The cpi can then be varied, but the width will not change.
- **BARCODE 145**. This Data Processing font prints at 145 dpi horizontally and 72 vertically. When chosen from the front panel, it defaults to 12 cpi. The cpi can then be varied, but the width will not change.
- **BARCODE 160**. This Data Processing font prints at 160 dpi horizontally and 72 vertically. When chosen from the front panel, it defaults to 13 cpi. The cpi can then be varied, but the width will not change.

### Typeface (Arabic Language)

**NOTE:** These Arabic typefaces appear at the end of the list above for the Arabic Language firmware only. They are only used when the Arabic Analyzer is enabled.

- **NLQ Naskhi bold**
- **NLQ Kofi**
- **NLQ Kofi bold**
- **NLQ Hadeeth**
- **NLQ Req'a**
- **NLQ Haydar**
- **NLQ Asri**

### Typeface (H-Series)

This parameter allows you to select the typeface for printing in the emulation.

- **LQ.** Default value for Hanzi Big5/Hangul.
- **Near LQ.** Default value for Hanzi GB/Kanji printer.
- **Normal**
- **Hi-Speed**
- **Super Hi-Speed**
- **Ultra Hi-Speed**

### Styling Typeface (H-Series)

- **SONG.** Only for Hanzi GB printer.
- **MING.** Only for Hanzi Big5 printer.
- **Mincho.** Only for Kanji printer.
- **Myungjo, Gothic.** Only for Hangul printer. Myungjo is the default value.

### Prop. Spacing (Proportional Spacing)

Each printed character is contained inside a character cell. The width of the character cell includes the character and the space around the character. This menu only works in ASCII mode and is not available for the H-Series Hangul product.

- **Disable** (factory default). Each character cell is printed with the same width. Each column in the printed text will line up.

```
This example is printed with
proportional spacing disabled.
```

- **Enable.** The width of each character cell varies with the width of the character. For example, [i] takes less space to print than [m]. Using proportional fonts generally increases the readability of printed documents, which gives text a typeset appearance.

```
This example is printed with
proportional spacing enabled.
```

### Bold Print

- **Disable** (factory default). Text is printed normally.
- **Enable.** Text is printed with a heavy line thickness.

### Italic Print

- **Disable** (factory default). Text is printed normally.
- **Forward Slant.** Text is printed with a forward slant.
- **Backward Slant.** Text is printed with a backward slant.

## Slashed Zero

This parameter allows you to print the numeral “0” with or without the slash. This option applies to all character sets except OCR-A and OCR-B.

- **Disable** (factory default). Zero is printed without a slash.
- **Enable**. Zero is printed with a slash.

## DBCS/ASCII Mode (H-Series)

- **DBCS Mode** (factory default). The printer is in DBCS mode. It can print double-byte characters as well as a limited number of single-byte characters.
- **ASCII Mode**. The printer is in ASCII mode. It can only print single-byte characters.

## DBCS ASCII Style (H-Series)

This parameter allows you to specify the appearance of the single-byte alphanumeric characters in DBCS mode.

- **Normal** (factory default).
- **Oversize**. The alphanumeric characters will appear larger than normal single-byte characters. For example, the appearance of character “8” will be changed to “8”.
- **OCRB**. The alphanumeric characters will print in OCRB style. It only takes effect on LQ typeface for Hanzi/Kanji printer.
- **Normal Thin**. The alphanumeric characters will be slightly thinner compared with Normal style. This is only applicable for Hangul printer.

## Text Position

Specifies where the text will be positioned in the line space. When set to Top-of-Line, text will be positioned at the top of the line space. When set to Bottom-of-Line, the text will be positioned as if it were at the bottom of a 6 lpi line space. The following example shows both Top-of-Line and Bottom-of-Line text positions:

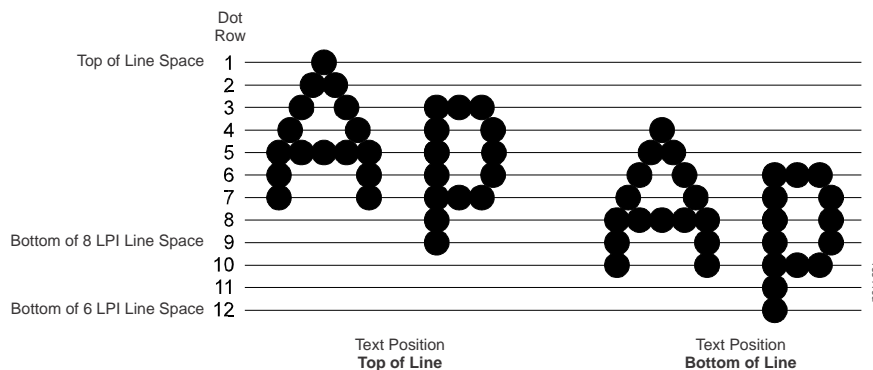

## ASCII Compatible

Allows you to specify ASCII characters print position alignment. This option affects device font characters only, and does not affect graphics or barcodes.

- **Disable** (factory default). The ASCII characters print position aligns (horizontally) with Indian characters.

- **Enable.** The ASCII characters print position shifts up to align (horizontally) with standard ASCII characters.

If Indian character sets, such as Hindi, Kannada, Gujarati or Tamil are selected, the menu will automatically switch to Disable. Enable will not be available for selection until non-Indian character sets are selected.

If the “Tall ASCII Font” option is available, the menu automatically switches to Disable. Enable will not be available for selection until the Tall ASCII Font is disabled.

### **Compressed Mode (H-Series)**

This parameter allows you to specify the appearance of ASCII/DBCS characters in ASCII mode. It is not applicable for the H-Series Hangul printer.

- **Disable** (factory default)
- **Enable.** Prints out ASCII mode ASCII characters and half-width DBCS characters.

### **DBCS Compressed (H-Series)**

This parameter allows you to specify the appearance of ASCII/DBCS characters in DBCS mode. It is not applicable for the H-Series Hangul printer.

- **Disable** (factory default)
- **Enable.** Both the DBCS and ASCII characters will be printed as half-width of their original size.

### **Font Scale (H-Series)**

This parameter allows you to specify the appearance of the font size. It is applicable for the H-Series GB printer.

- **Standard** (factory default). The character prints as 24 x 24 cell size.
- **16 x 24.** The character prints as 16 x 24 cell size.

### **Encoding (H-Series)**

- **Address Table** (factory default). Specifies the address table supported.  
**GB18030** is for Hanzi GB printer.  
**BIG5** (factory default), **CNS**, **TCA**, **ETEN**, **IBM5550**, **TELETEXT**, **BIG5+**, **BIG5E**, and **HKSCS** are for Hanzi Big5 printer.  
**KSC5601** is for Hangul printer.  
**Shift-JIS** is for Kanji printer.
- **UTF-8.** The printer takes in UTF-8 data stream and prints out according to Unicode format.

### **Taller 15 CPI (H-Series)**

This parameter allows you to specify the appearance of ASCII characters as 15 CPI in ASCII mode.

- **Disable** (factory default). The characters in 15 CPI appear shorter than other CPIs such as 10 CPI.
- **Enable.** The height of 15 CPI characters is the same as other CPIs such as 10 CPI.

### **Horizontal Expnd (H-Series)**

This parameter allows you to specify dot character horizontal expansion for both ASCII and DBCS characters in DBCS mode.

### Vertical Expnd (H-Series)

This parameter allows you to specify dot character vertical expansion for both ASCII and DBCS characters in DBCS mode.

### Graphics Spd Up (H-Series)

This menu is used to increase (speed up) graphic printing speed by turning on the Enhanced/Turbo mode.

- **Normal** (factory default). The printer prints at the given input graphics resolution.
- **Enhanced**. The printer provides first-level speed up, which means the speed is faster than Normal mode.
- **Turbo**. The printer provides second-level speed up, which means the speed is faster than Enhanced mode.
- **Match Typeface**. The input 180x180 dpi graphics resolution will drop-dot to the resolution which matches the typeface selected.

### Page Format

#### Form Length

Forms length is the number of lines that can be printed on a page. You can set the form length in inches, millimeters (mm), or as a function of the current lpi (lines per inch).

**NOTE:** When IPDS is active, the form length only displays as a function of lines.

#### Form Width

The form width can be specified in inches, millimeters, or as a function of the current cpi (characters per inch). The forms width set should not exceed the actual paper width.

**NOTE:** When IPDS is active, the form width only displays as a function of characters.

### Margins

- **Left Margin**. Set in columns. Column zero is defined as the far left edge of the page, and column numbering increments from left to right.
- **Right Margin**. Set in columns. Column zero is defined as the far right edge of the page, and column numbering increments from right to left.
- **Bottom Margin**. Defined in lines, starting from line zero at the bottom of the page and incrementing from the bottom up.

### Perforation Skip

- **Disable** (factory default). Allows printing on page perforation.
- **1/2 inch, 2/3 inch, 5/6 inch, 1 inch**. You may set up a skip-over margin of 1/2 inch, 2/3 inch, 5/6 inch, or 1 inch. For example, a skip-over margin of 1 inch allows a 1 inch margin at the bottom of the page.

### Print Char. Set

When this selection is displayed and the ENTER key is pressed, the current character set is printed.

### Indian Option

- **Indian Formatter**. The available options include Disable, Script Page, and Data Page.
  - **Disable** (factory default). The Indian characters will print without composing.

- **Script Page.** Allows printing of Indian characters with composing for non-table format.
- **Data Page.** Allows Indian character printing with composing for table- formatted data. Data Page does not support ESC sequence commands nor other single byte commands except for CR, LF, FF, BEL, DC1, and DC3.
- **Tall ASCII Font.** The available options include Enable and Disable.
  - **Disable** (factory default)
  - **Enable.** When enabling the Tall ASCII Font setting, the ASCII characters will print as tall fonts. This setting is available only for 10, 12, and 13.3 CPI for DP and NLQ settings. It is recommended to print the Tall ASCII font with 4 LPI setting or lower to avoid overlapping.
- **Space Width Adj.** The values range from 1 to 30. The default value is 12. This option allows spacing adjustment between the words in Indian character printing. This feature works only with Indian code pages and not with Standard code pages. The Space Width Adj value affects the character width of the space character (0x20) and the dash character (0x2D). The Space Width Adjust value is applicable to both script page and data page selections. Table 11 on page 120 shows the space width adjustment value according to its typeface and CPI setting.

**Table 11 Typeface, CPI, and Space Width Values on Indian Language Printers**

Typeface	CPI	Space Width
Data Processing	6	20
	10	12
	12	10
	13.3	9
	15	8
	17.1	7
Near Letter Quality	20	6
	6	30
	10	18
	12	15
	13.3	13
	15	12
	17.1	10

- **Hindi Numeral.** Allows you to specify whether to print numbers as Hindi numerals.
  - **Disable** (factory default)
  - **Enable.** When enabled, numbers will print as Hindi numerals.

#### **Reset Cmd CFG Ld**

When the printer receives a host data stream reset command (ESC @ or ESC[K) in addition to resetting printer variables, the selected configuration is loaded.



- **Disable** (factory default). The active emulation parameters are loaded when the reset command is executed.
- **Power-Up Config**. The power-up configuration is loaded when the reset command is executed.
- **Current Config**. The currently selected configuration is loaded when the reset command is executed.
- **Factory Config**. The factory installed configuration is loaded when the reset command is executed.

### Set Substitution

When this option is activated, the character set overlay in RAM is activated. This can also be accomplished through a host command of **SFCC RX**. In either case, a flag is set indicating that the substitution table is active. If the power-up configuration has Ld Set at Pwrup and Set Substitution both enabled, the character set overlay is automatically activated at power-up or during a soft reset. See the *LinePrinter Plus Programmer's Reference Manual* for more information.

### Barcode x-offset

- **Disable** (factory default)
- **Enable**. Allows text to print next to a barcode when xxxx and yyyy are not set to the origin.

### Barcode Height

- **Disable** (factory default)
- **Enable**. If Barcode x-offset is enabled, the barcode height follows P5000 legacy barcode behavior.

### Error Handling (H-Series)

This command determines the way illegal DBCS characters are processed:

- **Normal** (factory default). Will ignore illegal DBCS characters.
- **As Space**. Will insert two space characters (0X20, 0X20) when the data stream contains the illegal DBCS character.
- **As Square**. Will insert a black square (0xA1BD) when the data stream contains the illegal DBCS character. This is applicable for the Hanzi Big5 build only.

## P-Series Emulation

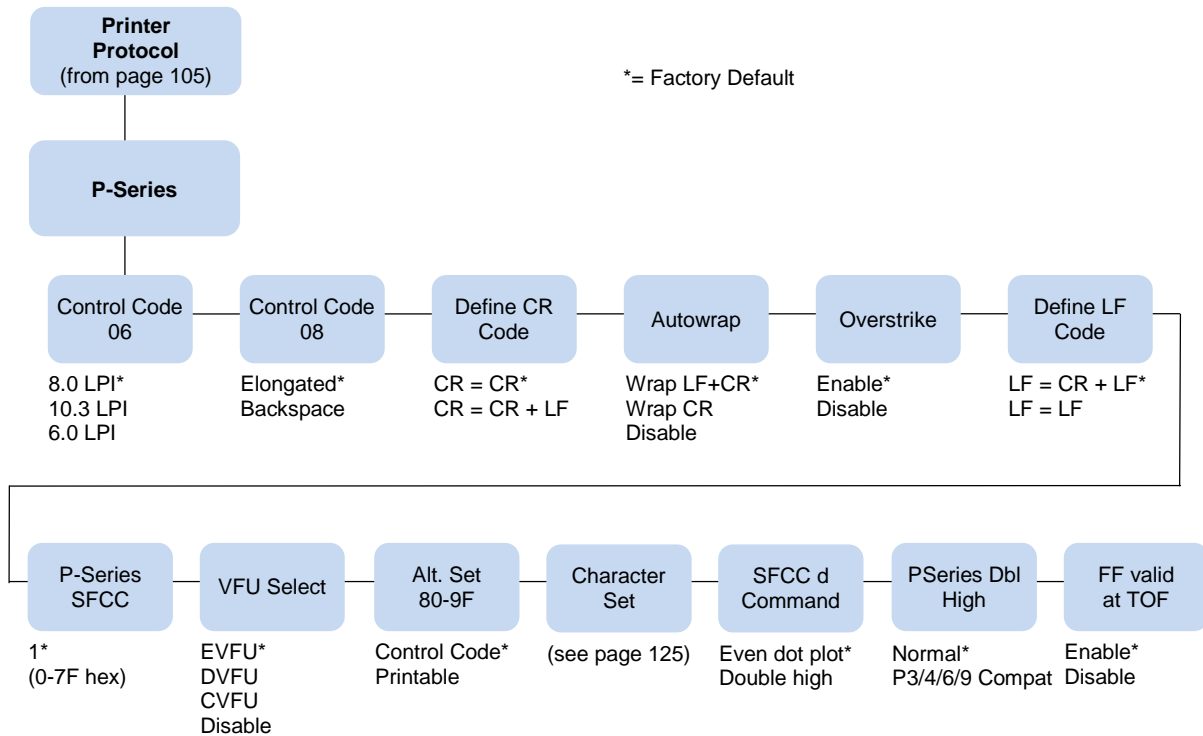

### Control Code 06

Control Code 06 defines the function of ASCII code hex 06 (ACK). You can select an alternate line spacing of 6, 8, or 10.3 LPI.

### Control Code 08

Control Code 08 defines the function of ASCII code hex 08 (BS). You can define the code to output the following character:

- **Elongated** (factory default).
- Backspace.

### Define CR Code

This option controls the action of the printer when it receives a Carriage Return code (hex 0D) from the host computer. If this feature is enabled, each time the printer receives a carriage return, it inserts an additional Line Feed code (hex 0A) into the data stream. Do not use this feature if the host computer sends Line feeds to the printer.

- **CR = CR** (factory default). Does not insert an extra line feed after each carriage return.
- **CR = CR + LF**. Inserts an extra line feed after each carriage return. The next print position will be print position 1 of the next line.

## **Autowrap**

This option defines the printer action when print data is received past the forms width setting.

- **With LF+CR** (factory default). Performs an automatic carriage return and line feed when data is received past the forms width, causing the excess text to print on the next line.
- **With CR**. Performs an automatic carriage return (without line feed) when data is received past the forms width.
- **Disable**. Discards any data past the forms width.

## **Overstrike**

This option enables you to print bold characters.

- **Enable** (factory default). Turns on bold print. When enabled, overstrike printing slows down the printer.
- **Disable**. Turns off bold print.

## **Define LF Code**

- **LF = CR + LF** (factory default). Forces an automatic carriage return with each line feed command. The next print position is print position 1 of the next line.
- **LF = LF**. Does not perform an automatic carriage return. The next print position will be the current print position of the next line.

## **P-Series SFCC**

This parameter allows you to select which ASCII codes will function as the Special Function Control Code (SFCC) command delimiter.

P-Series codes can use hex 00 through hex 7F. Options include the following:

- ESC (hex 1B)
- SOH (hex 01)
- ETX (hex 03)
- CIRCUMFLEX (hex 5E)—also called caret (^)
- TILDE (hex 7E)—(~)

**NOTE:** SOH, ETX, and ESC are non-printables. The characters (^) and (~) are printable; however, do not use them as printables in the host data stream if either is chosen as a delimiter because print errors will occur.

## **VFU Select**

Controls how the printer handles vertical formatting.

- **EVFU** (factory default). Enables the VFU and selects P-Series compatible Electronic Vertical Format Unit (EVFU).
- **DVFU**. Enables the VFU and selects the Dataproducts compatible Direct Access Vertical Format Unit (DVFU).
- **CVFU**. Enables the VFU and selects the Centronics compatible Direct Access Vertical Format Unit (CVFU).
- **Disable**. Disables all VFU processing.

### **Alt. Set 80-9F**

Determines whether the printer processes ASCII codes hex 80 through hex 9F as control codes or as printable characters. The options include:

- **Control Code** (factory default)
- **Printable.**

### **Character Set**

Specifies a character set as shown in the P-Series Character Set Menu on page 125. To use one of these sets, choose the desired group heading (such as European Sets) and press ENTER. Then choose the desired set within that group (such as Roman 8) and press ENTER. Both the group and the desired set will be starred to indicate your selection. The UTF-8 selection allows printing of UTF-8 encoded Unicode™. Character sets are shown in detail in the *Character Sets Reference Manual*.

### **SFCC d Command**

- **Even dot plot** (factory default). This option interprets SFCC d Command as even dot plot.
- **Double High.** This option interprets SFCC d Command as double high. Select this option for backward compatibility.

### **PSeries Dbl High**

Allows printing compatibility between current and older model printers.

- **Normal** (factory default). This is normal, double-high printing for current model printers.
- **P3/4/6/9 Compat.** Where older printers print two dot rows higher, this option allows for compatibility by raising the print two dot rows to match the current models dot row value (two dot rows lower).

### **FF Valid at TOF**

- **Enable** (factory default). Performs a form feed when the host sends a Form Feed command and the printer is at the top of form.
- **Disable.** Will not perform a form feed when the host sends a Form Feed command and the printer is at the top of form.

# P-Series Character Set Menu

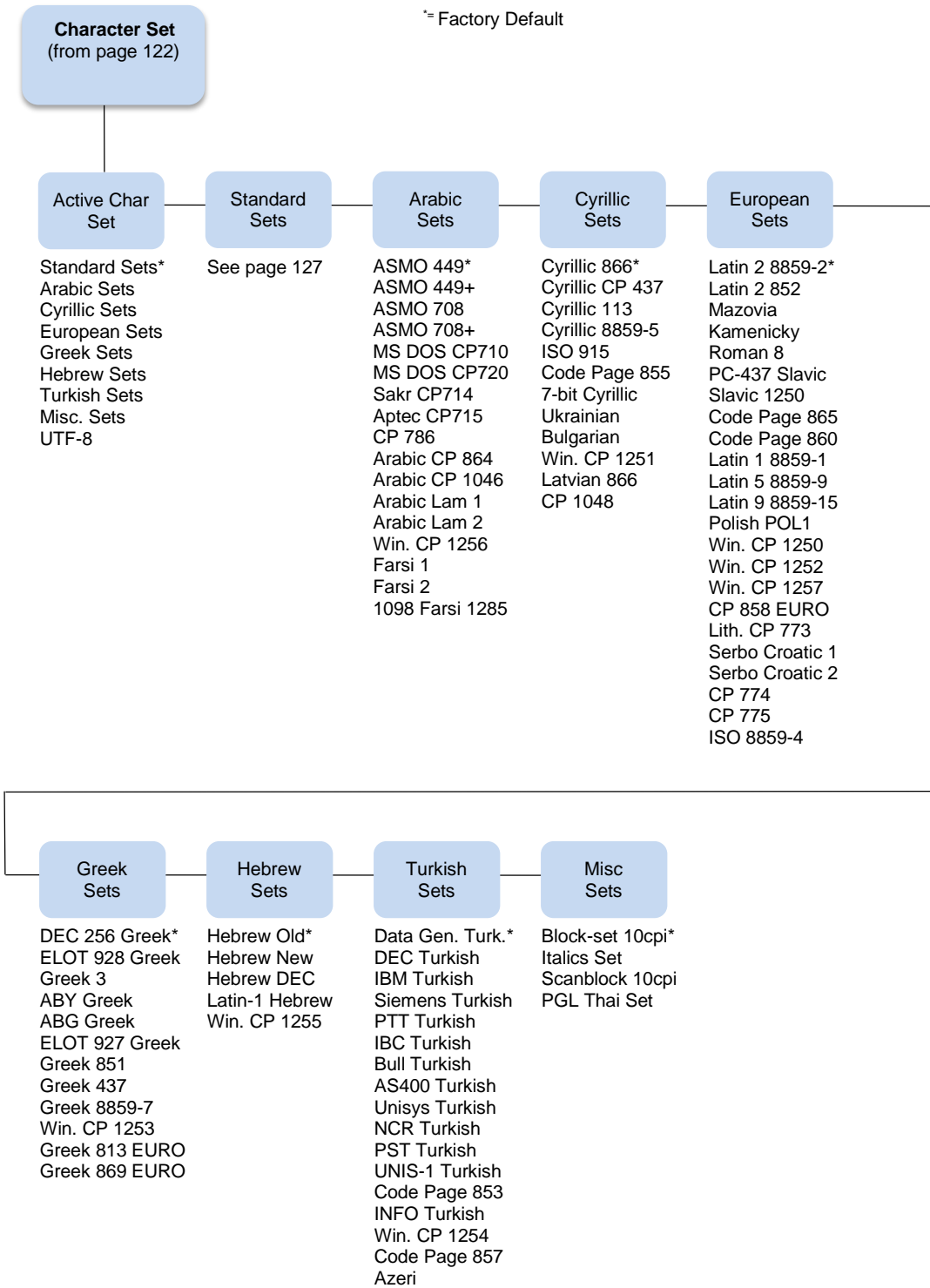

# Indian Language Character Set Menu

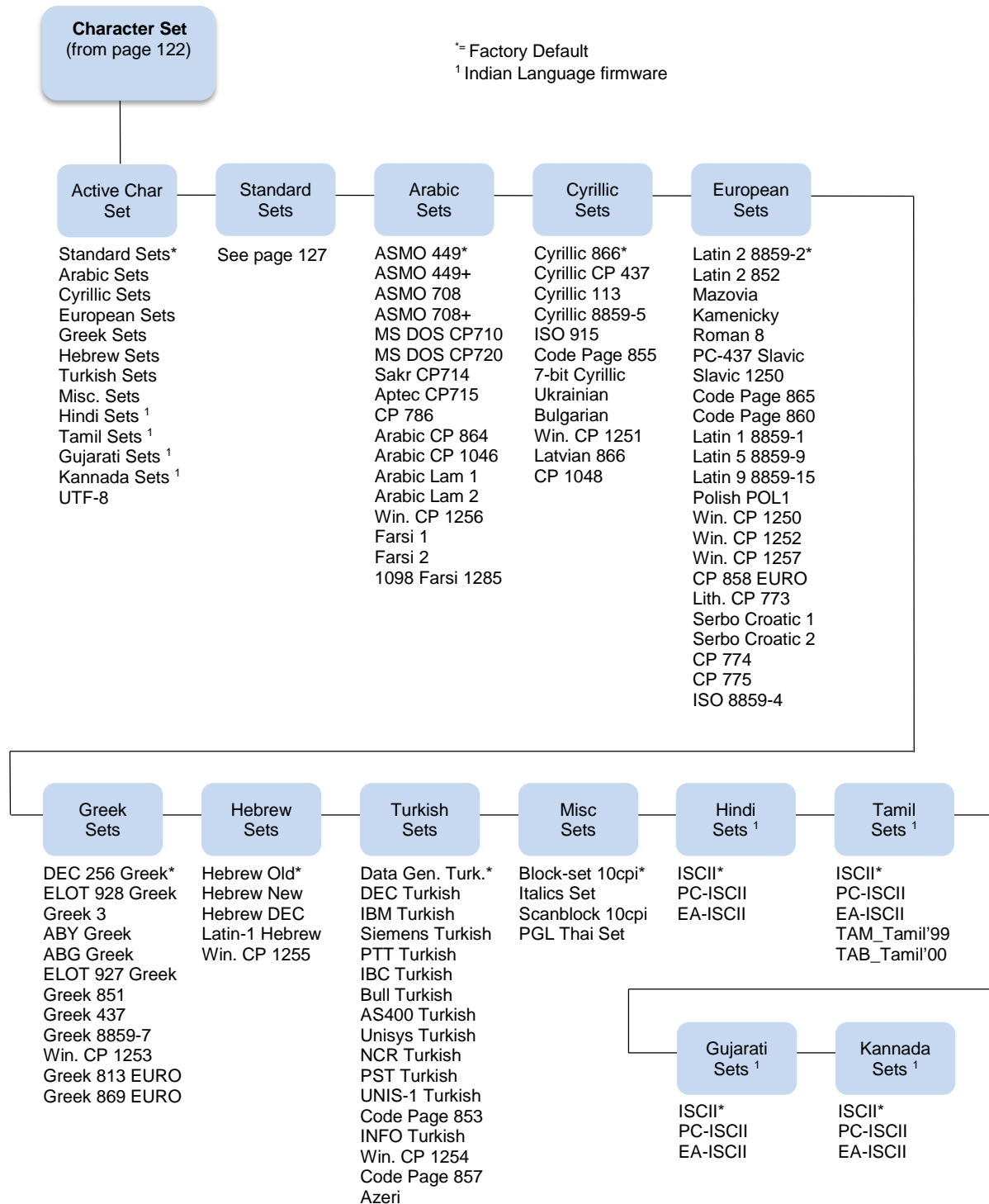

**NOTE:** The Indian Language Character Set Menu applies to P-Series and all LinePrinter+ protocols.

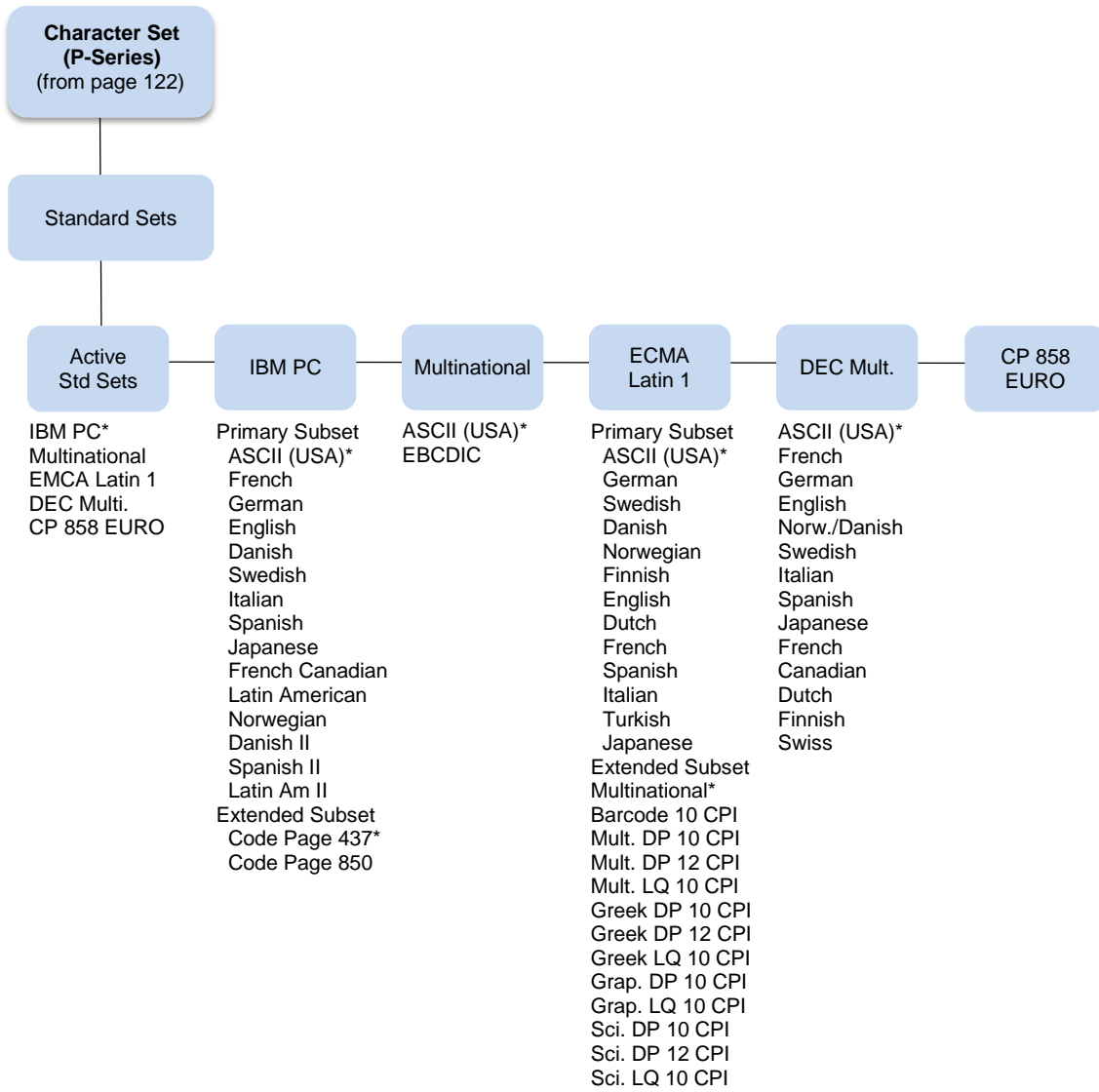

## P-Series XQ Emulation

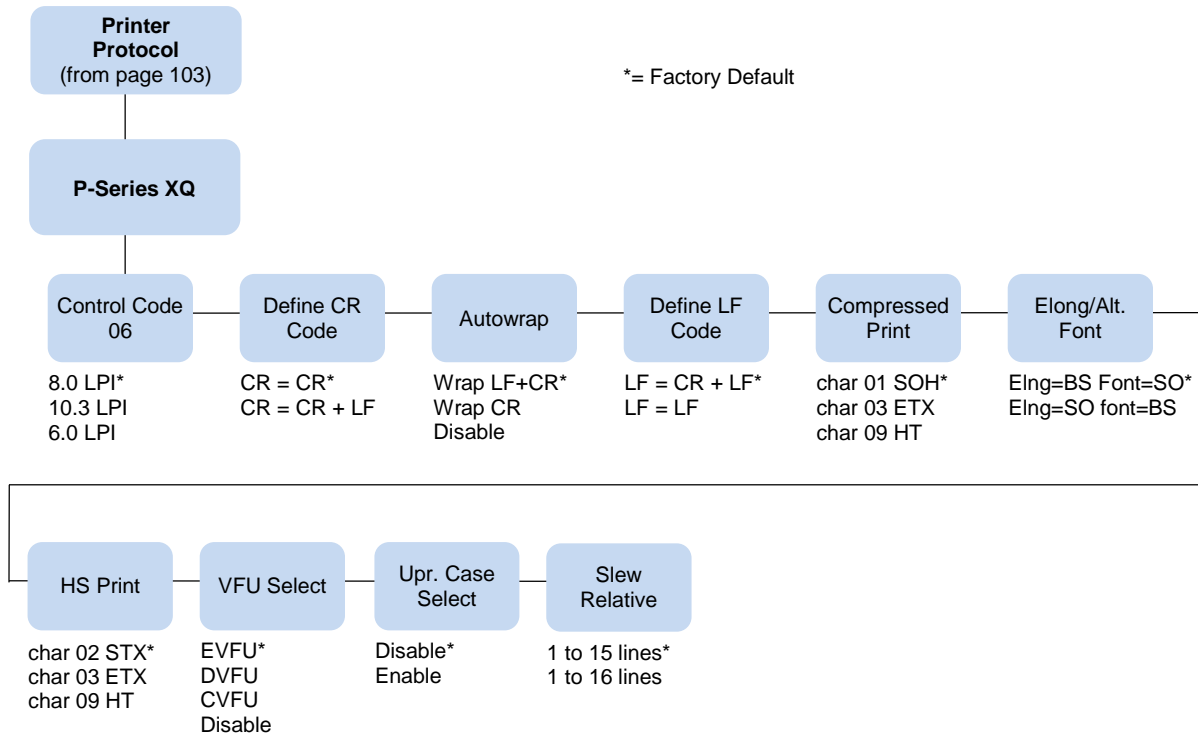

### Control Code 06

Control Code 06 defines the function of ASCII code hex 06 (ACK). You can select an alternate line spacing of 6, 8, or 10.3 LPI.

### Define CR Code

This option controls the action of the printer when it receives a Carriage Return code (hex 0D) from the host computer. If this feature is enabled, each time the printer receives a Carriage Return, it inserts an additional Line Feed code (hex 0A) into the data stream. Do not use this feature if the host computer sends line feeds to the printer.

- **CR = CR** (factory default). Does not insert an extra line feed after each carriage return.
- **CR = CR + LF**. Inserts an extra line feed after each carriage return. The next print position will be print position 1 of the next line.

### Autowrap

This option defines the printer action when print data is received past the forms width setting.

- **With LF+CR** (factory default). Performs an automatic carriage return and line feed when data is received past the forms width.
- **With CR**. Performs an automatic carriage return (without line feed) when data is received past the forms width.
- **Disable**. Discards any data past the forms width.



### Define LF Code

- **LF = CR + LF** (factory default). Forces an automatic carriage return with each line feed command received. The next print position is print position 1 of the next line.
- **LF = LF**. Does not perform an automatic carriage return when a line feed command is received. The next print position will be the current print position of the next line.

### Compressed Print

Controls which host command sets compressed printing.

- **Char 01 SOH** (factory default)
- **Char 03 ETX**
- **Char 09 HT**

### Elong/Alt. Font

Controls which host command sets elongated (double high) fonts and extended character set.

- **EIng=BS Font=SO** (factory default)
- **EIng=SO Font=BS**

### HS Print (High Speed Print)

Controls which host command sets high speed printing.

- **Char 02 STX** (factory default)
- **Char 03 ETX**
- **Char 09 HT**

### VFU Select

Controls how the printer handles vertical formatting. The choices are:

- **EVFU** (factory default). Enables the VFU and selects P-Series compatible Electronic Vertical Format Unit (EVFU).
- **DVFU**. Enables the VFU and selects the Dataproducts compatible Direct Access Vertical Format Unit (DVFU).
- **CVFU**. Enables the VFU and selects the Centronics compatible Direct Access Vertical Format Unit (CVFU).
- **Disable**. Disables all VFU processing.

### Upr. Case Select

Controls how the printer handles lowercase characters it receives from the host computer. When enabled, all characters will be printed in uppercase.

- **Disable** (factory default). Prints lowercase characters received from the host computer as lowercase, and prints uppercase characters received from the computer as uppercase.
- **Enable**. Prints lowercase characters received from the host computer as their corresponding uppercase equivalents; uppercase characters received from the computer print as uppercase.

## Slew Relative

“Slewing” is rapid vertical paper movement. This parameter determines the number of lines slewed (either 1-15 lines or 1-16 lines) when an EVFU Slew Relative command is received. The options include:

- **1-15 Lines**
- **1-16 Lines** (factory default)

## Serial Matrix Emulation

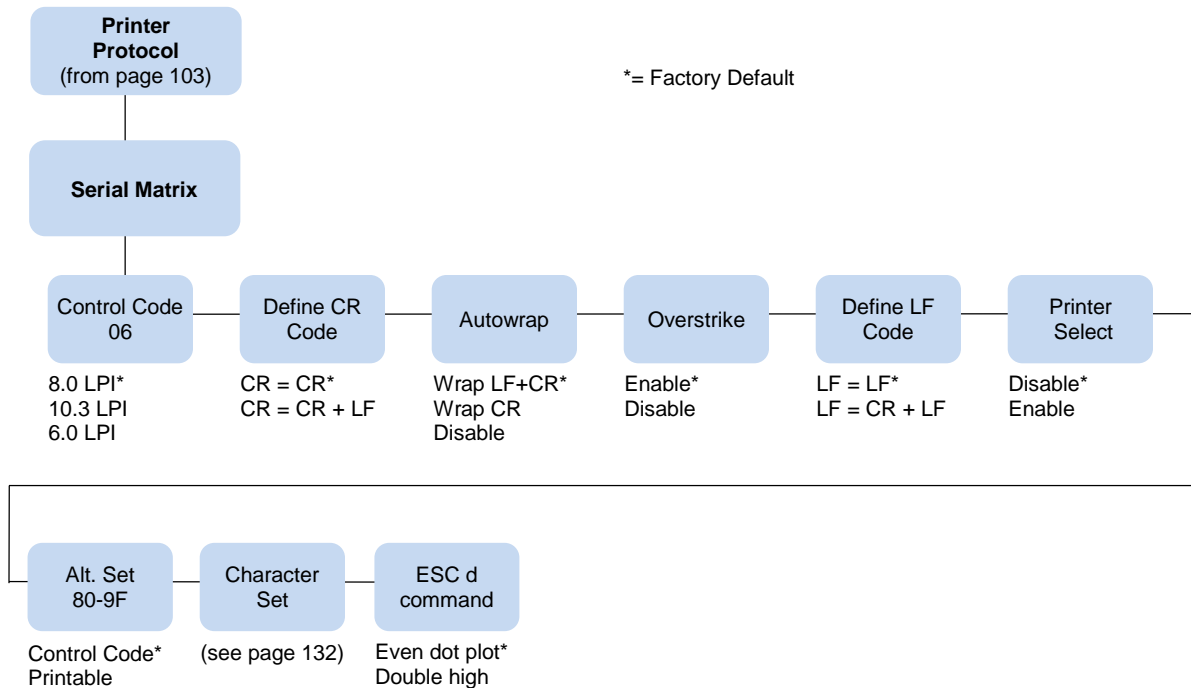

### Control Code 06

Control Code 06 defines the function of ASCII code hex 06 (ACK). You can select an alternate line spacing of 6, 8, or 10.3 LPI.

### Define CR Code

This option controls the action of the printer when it receives a Carriage Return code (hex 0D) from the host computer. If this feature is enabled, each time the printer receives a Carriage Return, it inserts an additional Line Feed code (hex 0A) into the data stream. Do not use this feature if the host computer sends line feeds to the printer.

- **CR = CR** (factory default). Does not insert an extra line feed after each carriage return.
- **CR = CR + LF**. Inserts an extra line feed after each carriage return. The next print position will be print position 1 of the next line.

## **Autowrap**

This option defines the printer action when print data is received past the forms width setting.

- **With LF+CR** (factory default). Performs an automatic carriage return and line feed when data is received past the forms width.
- **With CR**. Performs an automatic carriage return (without line feed) when data is received past the forms width.
- **Disable**. Discards any data past the forms width.

## **Overstrike**

This option enables you to print bold characters.

- **Enable** (factory default). Turns on bold print. When enabled, overstrike printing slows down the printer.
- **Disable**. Turns off bold print.

## **Define LF Code**

- **LF = LF** (factory default). Does not perform an automatic carriage return when a line feed command is received. The next print position will be the current print position of the next line.
- **LF = CR + LF**. Forces an automatic carriage return with each line feed command received. The next print position is print position 1 of the next line.

## **Printer Select**

- **Disable** (factory default). Ignores the ASCII DC1 and DC3 control codes.
- **Enable**. Disables the printer when a DC1 control code is received, and enables the printer when a DC3 control code is received.

## **Alt. Set 80-9F**

- **Control Code** (factory default). Interprets data in the range of hex 80 through hex 9F as a control code.
- **Printable**. Prints data in the range of hex 80 through hex 9F.

## **Character Set**

Specifies a character set as shown in the Serial Matrix Character Set Menu on page 132. To use one of these sets, choose the desired group heading (such as European Sets) and press ENTER. Then choose the desired set within that group (such as Roman 8) and press ENTER. Both the group and the desired set will be starred to indicate your selection. Character sets are shown in detail in the *Character Sets Reference Manual*.

## **ESC d command**

- **Even dot plot** (factory default). Interprets the ESC d command as even dot plot.
- **Double high**. Interprets the ESC d Command as double high. Select this option for backward compatibility.

# Serial Matrix Character Set Menu

**Character Set**  
(from page 130)

\*= Factory Default

**Note:** Indian Language Character sets are shown on page 126

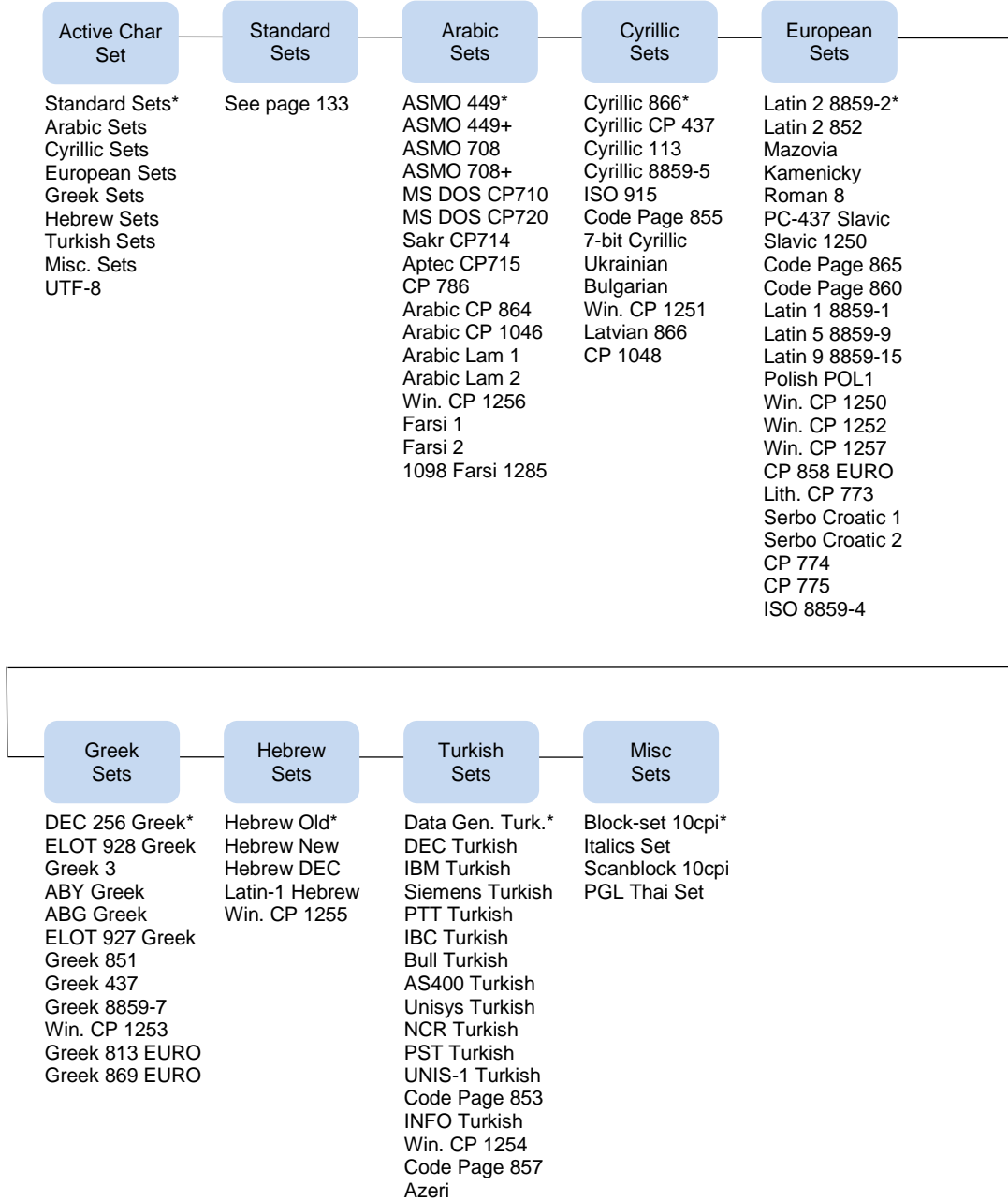

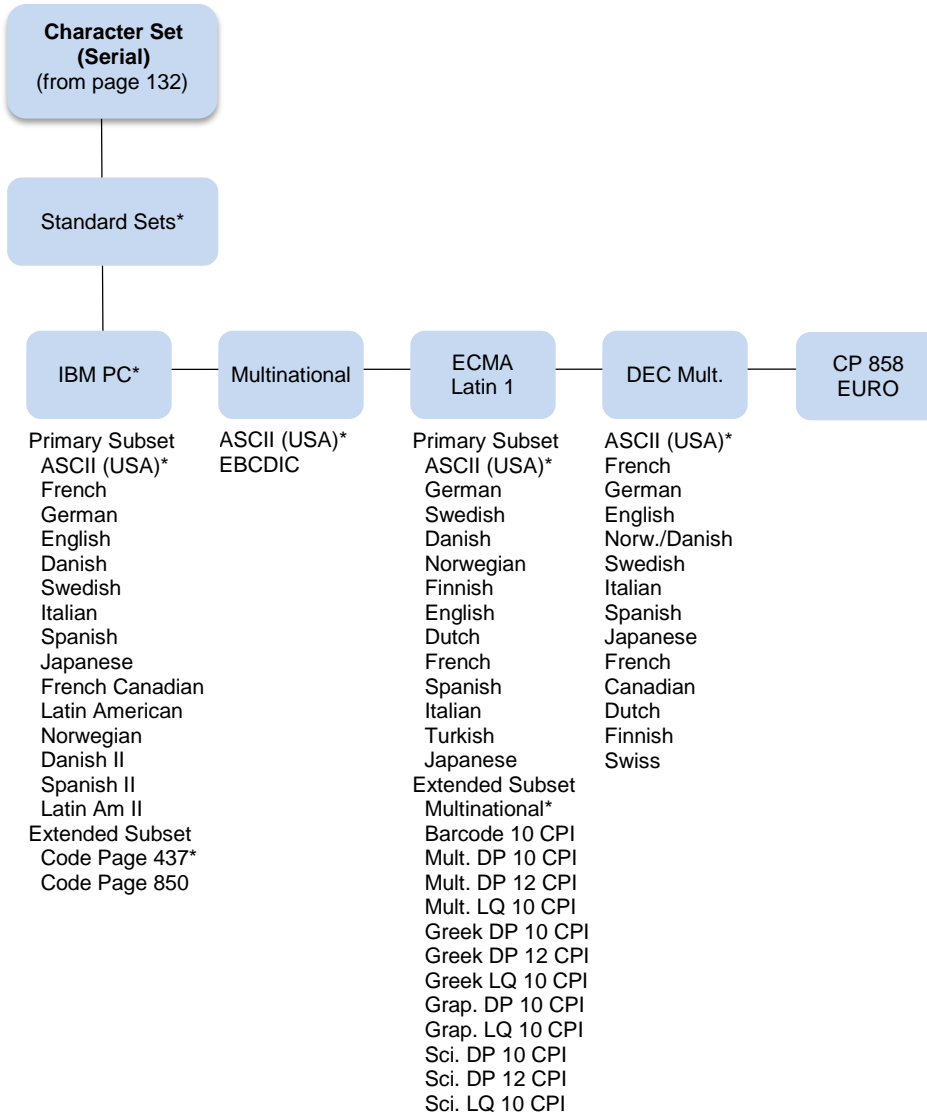

**Proprinter**

**XL Emulation**

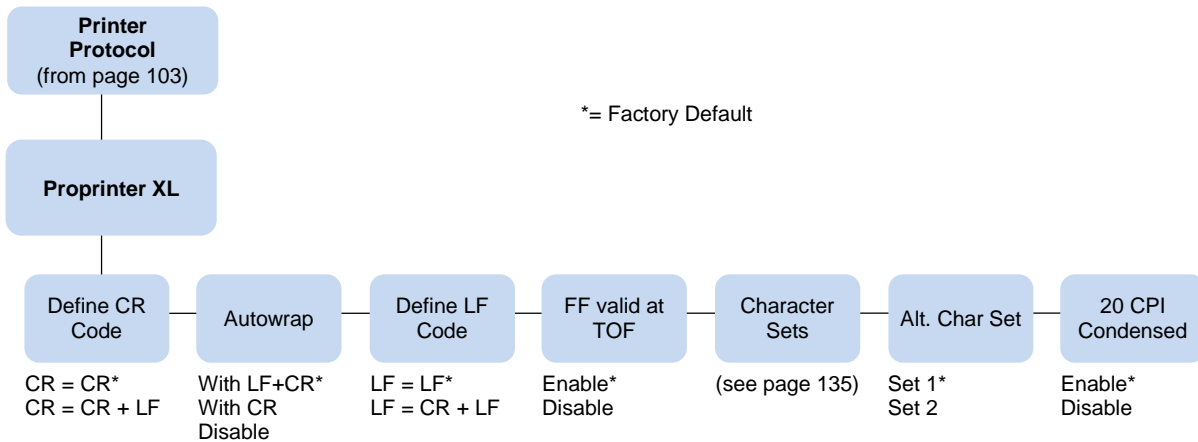

### Define CR Code

This option controls the action of the printer when it receives a Carriage Return code (hex 0D) from the host computer. If this feature is enabled, each time the printer receives a Carriage Return, it inserts an additional Line Feed code (hex 0A) into the data stream. Do not use this feature if the host computer sends line feeds to the printer.

- **CR = CR** (factory default). Does not insert an extra line feed after each carriage return.
- **CR = CR + LF**. Inserts an extra line feed after each carriage return.

### Autowrap LF

This option defines the printer action when print data is received past the forms width setting.

- **With LF+CR** (factory default). Performs an automatic carriage return and line feed when data is received past the forms width.
- **With CR**. Performs an automatic carriage return (without line feed) when data is received past the forms width.
- **Disable**. Discards any data past the forms width.

### Define LF Code

- **LF = LF** (factory default). Does not perform an automatic carriage return when a Line Feed command is received. The next print position will be the current print position of the next line.
- **LF = CR + LF**. Forces an automatic carriage return with each Line Feed command received. The next print position is print position 1 of the next line.

### FF Valid at TOF

- **Enable** (factory default). Performs a form feed when the host sends a Form Feed command and the printer is at the top of form.
- **Disable**. Will not perform a form feed when the host sends a Form Feed command and the printer is at the top of form.

### Character Set

Specifies a character set as shown in Proprinter XL Character Sets Menu on page 135. To use one of these sets, choose the desired group heading (such as European Sets) and press ENTER. Then choose the desired set within that group (such as Roman 8) and press ENTER. Both the group and the desired set will be starred to indicate your selection. The UTF-8 selection allows printing of UTF-8 encoded Unicode™. Character sets are shown in detail in the *Character Sets Reference Manual*.

### Alt. Char Set

This option determines if data in the range of hex 80 through hex 9F should be interpreted as a control code or as a printable character.

- **Set 1** (factory default). Interprets data in the range of hex 80 through hex 9F as a control code.
- **Set 2**. Prints data for the characters at hex locations 03, 04, 05, 06, 15, and 80 through 9F.

### 20 CPI Condensed

Compressed print characters are narrower than the normal character set. This is helpful for applications where you need to print the maximum amount of information on a page.

- **Enable** (factory default). Prints characters about 60 percent the width of normal characters when compressed print is chosen by the host computer.
- **Disable**. Does not compress print widths, even if condensed print is chosen by the host.

# Proprinter XL Character Sets Menu

**Character Set**  
(from page 133)

\*= Factory Default

**Note:** Indian Language Character sets are shown on page 126

Active Char Set	Standard Sets	Arabic Sets	Cyrillic Sets	European Sets
Standard Sets* Arabic Sets Cyrillic Sets European Sets Greek Sets Hebrew Sets Turkish Sets Misc. Sets UTF-8	Active Std Sets Code Page 437* Code Page 850 OCR-A OCR-B Multinational CP 858 EURO Multinational ASCII (USA)* EBCDIC	ASMO 449* ASMO 449+ ASMO 708 ASMO 708+ MS DOS CP710 MS DOS CP720 Sakr CP714 Aptec CP715 CP 786 Arabic CP 864 Arabic CP 1046 Arabic Lam 1 Arabic Lam 2 Win. CP 1256 Farsi 1 Farsi 2 1098 Farsi 1285	Cyrillic 866* Cyrillic CP 437 Cyrillic 113 Cyrillic 8859-5 ISO 915 Code Page 855 7-bit Cyrillic Ukrainian Bulgarian Win. CP 1251 Latvian 866 CP 1048	Latin 2 8859-2* Latin 2 852 Mazovia Kamenicky Roman 8 PC-437 Slavic Slavic 1250 Code Page 865 Code Page 860 Latin 1 8859-1 Latin 5 8859-9 Latin 9 8859-15 Polish POL1 Win. CP 1250 Win. CP 1252 Win. CP 1257 CP 858 EURO Lith. CP 773 Serbo Croatic 1 Serbo Croatic 2 CP 774 CP 775 ISO 8859-4
Greek Sets DEC 256 Greek* ELOT 928 Greek Greek 3 ABY Greek ABG Greek ELOT 927 Greek Greek 851 Greek 437 Greek 8859-7 Win. CP 1253 Greek 813 EURO Greek 869 EURO	Hebrew Sets Hebrew Old* Hebrew New Hebrew DEC Latin-1 Hebrew Win. CP 1255	Turkish Sets Data Gen. Turk.* DEC Turkish IBM Turkish Siemens Turkish PTT Turkish IBC Turkish Bull Turkish AS400 Turkish Unisys Turkish NCR Turkish PST Turkish UNIS-1 Turkish Code Page 853 INFO Turkish Win. CP 1254 Code Page 857 Azeri	Misc Sets Block-set 10cpi* Italics Set Scanblock 10cpi PGL Thai Set	

## Epson FX Emulation

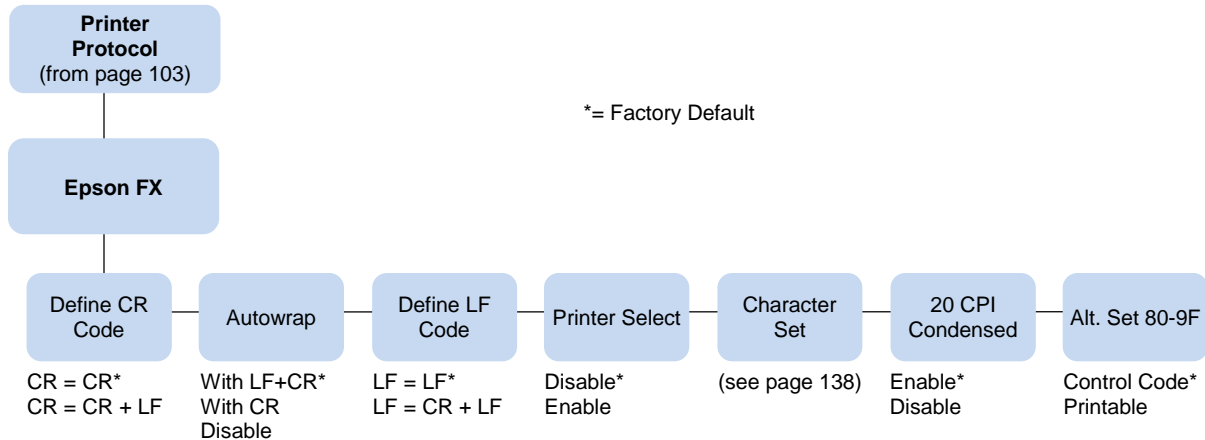

### Define CR Code

The Define CR Code option controls the action of the printer when it receives a Carriage Return code (hex 0D) from the host computer. If this feature is enabled, each time the printer receives a carriage return, it inserts an additional Line Feed code (hex 0A) into the data stream. Do not use this feature if the host computer sends line feeds to the printer.

- **CR = CR** (factory default). Does not insert an extra line feed after each carriage return.
- **CR = CR + LF**. Inserts an extra line feed after each carriage return.

### Autowrap

This option defines the printer actions when print data is received past the forms width setting.

- **With LF+CR** (factory default). Performs an automatic carriage return and line feed when data is received past the forms width.
- **With CR**. Performs an automatic carriage return (without line feed) when data is received past the forms width.
- **Disable**. Discards any data past the forms width.

### Define LF Code

The Define LF Code option controls the action of the printer when it receives a Line Feed code (hex 0A) from the host computer. If this feature is enabled, each time the printer receives a Line Feed, it inserts an additional Carriage Return code (hex 0D) into the data stream. This feature is required if the host computer does not send carriage returns to the printer.

- **LF = LF** (factory default). Does not add a carriage return with a line feed.
- **LF = CR + LF**. Adds an extra carriage return with each line feed.

### Printer Select

- **Disable** (factory default). Ignores the ASCII DC1 and DC3 control codes.
- **Enable**. Disables the printer when a DC1 control code is received, and enables the printer when a DC3 control code is received.



## Character Set

This parameter selects a character set for the Epson emulation, as shown in Epson FX Character Set Menu on page 138.

**NOTE:** When OCR-A or OCR-B is selected as the print language, the Font Attribute Typeface option under the LinePrinter Plus menu (page 102) is changed to OCR-A or OCR-B, respectively.

To use one of these sets, choose the desired group heading (such as European Sets) and press ENTER. Then choose the desired set within that group (such as Roman 8) and press ENTER. Both the group and the desired set will be starred to indicate your selection. The UTF-8 selection allows printing of UTF-8 encoded Unicode™. Character sets are shown in detail in the *Character Sets Reference Manual*.

## 20 CPI Condensed

Compressed print characters are narrower than the normal character set. This is helpful for applications where you need to print the maximum amount of information on a page.

- **Enable** (factory default). Prints about 60 percent of the width of normal characters when compressed print is chosen by the host computer. For example, a 12 CPI Draft font will compress to 20 CPI.
- **Disable**. Does not compress print widths, even if condensed print is chosen by the host.

## Alt. Set 80-9F

- **Control Code** (factory default). Interprets data in the range of hex 80 through hex 9F as a control code.
- **Printable**. Prints data in the range of hex 80 through hex 9F.

# Epson FX Character Set Menu

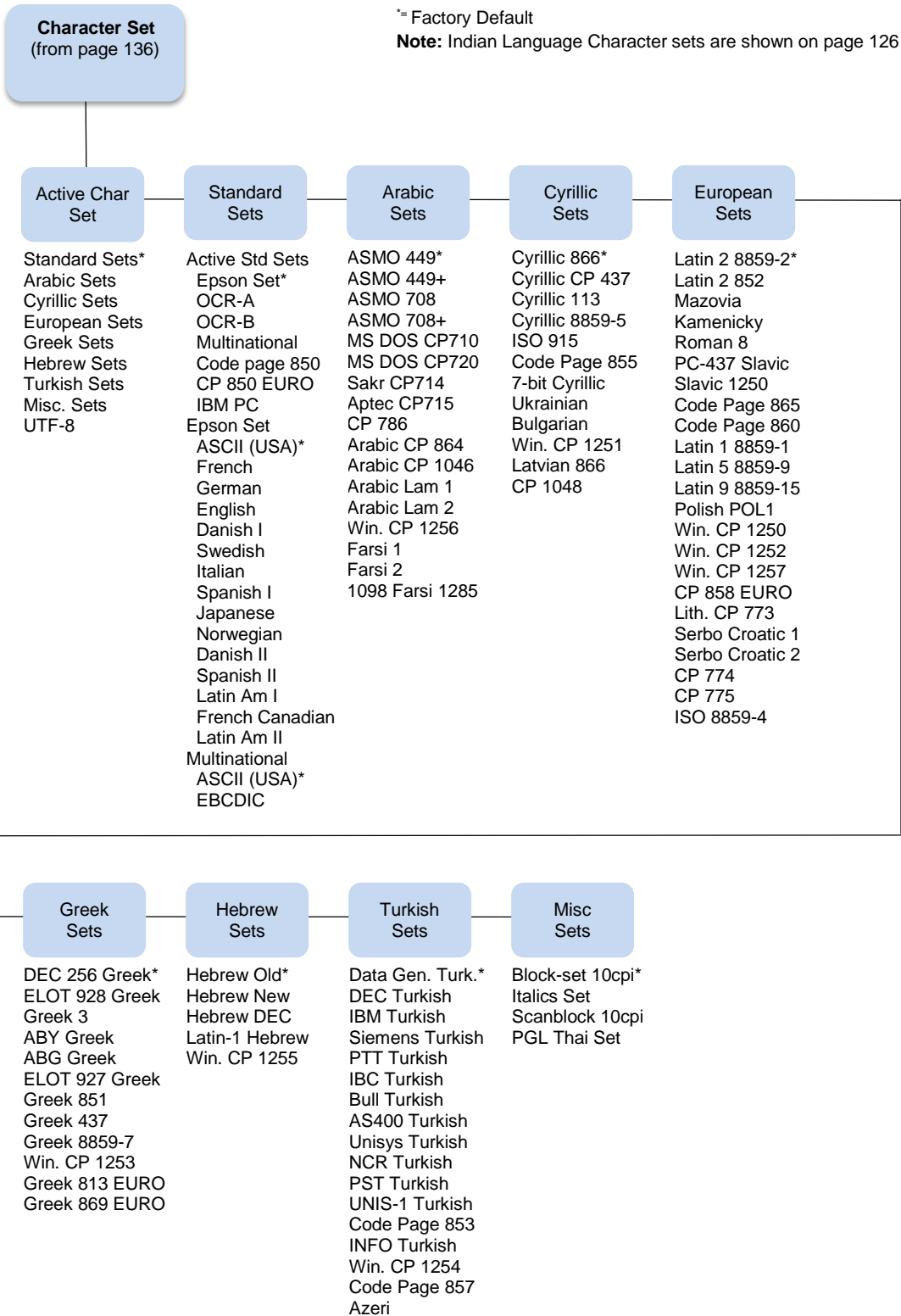

# ANSI Emulation

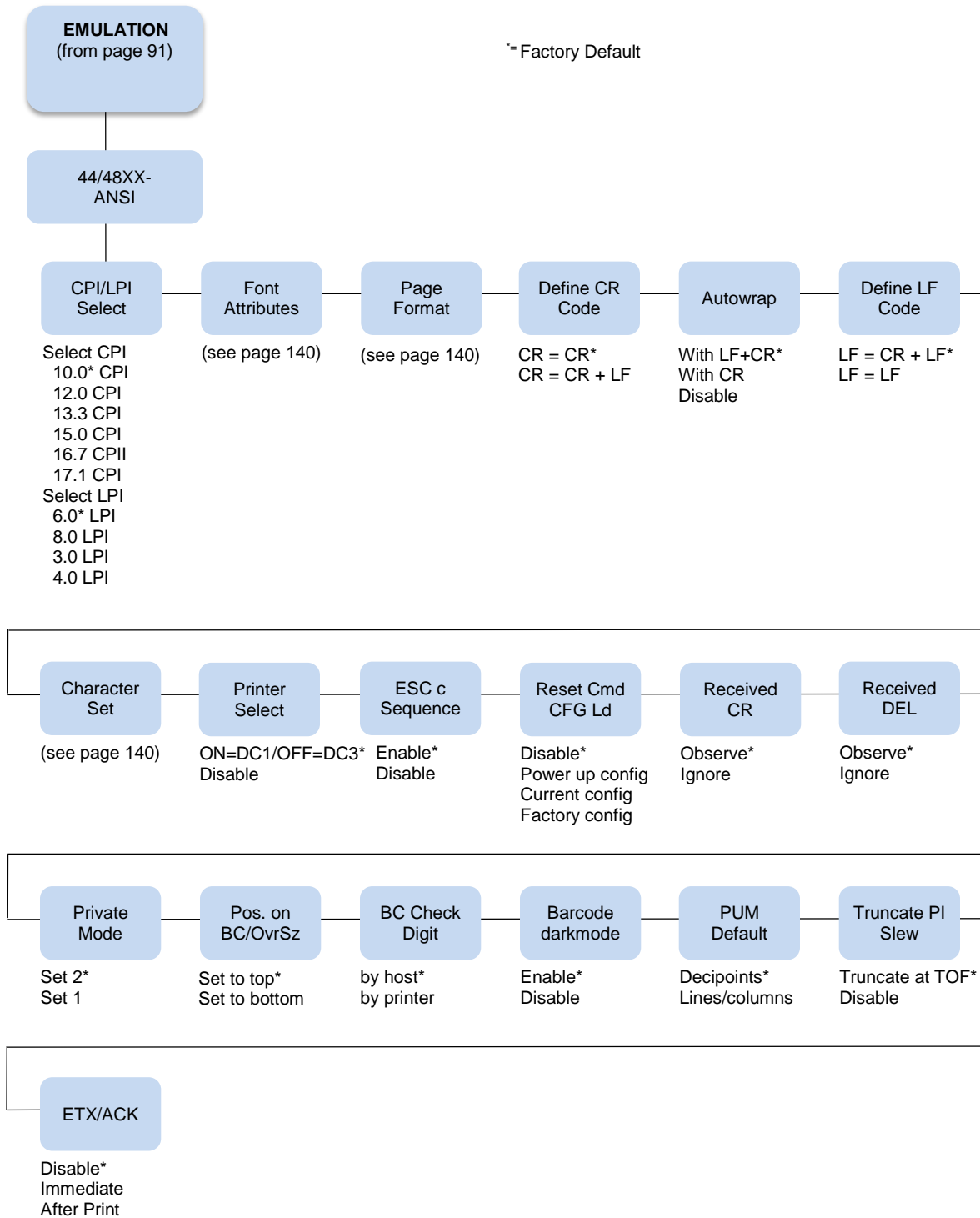

**Font Attributes**  
(from page 139)

**Typeface**

Data Processing\*  
Gothic NLQ  
Char. Graphics  
High Speed  
Italics NLQ  
Courier NLQ  
OCR-A  
OCR-B

**Prop. Spacing**

Disable\*  
Enable

**Bold Print**

Disable\*  
Enable

**Slashed Zero**

Disable\*  
Enable

**Character Set**  
(from page 139)

**Page Format**  
(from page 139)

**Margins**

Left Margin  
0 columns\*  
(0-369)  
Right Margin  
0 columns\*  
(0-369)  
Top Margin  
0 lines\*  
(0-451)  
Bottom Margin  
0 lines\*  
(0-451)

**Form Length**

Funct. of lines  
66 lines\*  
(1-192)

**Form Width**

Function of CPI  
136 Characters\*  
(1-272)

Latin 1 8859-1\*  
Cyrillic 8859-5  
IBM PC-2 CP 437  
IBM PC-2 CP 850  
Slavic CP 852  
Cyrillic CP 855  
Fr. Can. CP 863  
Russian CP 866  
Greek CP 851  
Turkish CP 853  
Protug. CP 860  
Arabic CP 864  
Nordic CP 865  
Latin 2 8859-2  
Latin 3 8859-3  
Latin 4 8859-4  
Lat. Ara. 8859-6  
Lat. Gre. 8859-7  
Lat. Heb. 8859-8  
Latin 5 8859-9  
Turkish2 CP 867  
Pol. Maz. CP 8576  
Turkish CP 8577  
Greek CP 8573  
Italian CP 23  
Spanish CP 24

Latin 9 8859-15  
DEC 256 Greek  
Turkish CP 857  
USA  
German  
French A  
French B  
French Canadian  
Dutch Netherlands  
Italian  
United Kingdom  
Spanish  
Danish/Norw. A  
Danish/Norw. B  
Danish/Norw. C  
Danish/Norw. D  
Swed./Finnish A  
Swed./Finnish B  
Swed./Finnish C  
Swed./Finnish D  
Swiss  
USA  
Yugoslavian  
United Kingdom A  
Turkish  
Greek  
DEC Mult.  
Roman 8

## CPI/LPI Select

Defines the default values for the horizontal and vertical character spacing. The number of characters per inch can range from 10.0 through 17.1. The number of lines per inch can range from 3.0 through 8.0.

## Font Attributes

### Typeface

Choose a typeface from the available options.

### Prop. Spacing (Proportional Spacing)

Each printed character is contained inside a character cell. The width of the character cell includes the character and the space around the character.

- **Disable** (factory default). Each character cell is printed with the same width. Each column in the printed text will line up.

```
This example is printed with
proportional spacing disabled.
```

- **Enable**. The width of each character cell varies with the width of the character. For example, [i] takes less space to print than [m]. Using proportional fonts generally increases the readability of printed documents, giving text a typeset appearance.

```
This example is printed with
proportional spacing enabled.
```

### Bold Print

- **Disable** (factory default). Text is printed normally.
- **Enable**. Text is printed with a heavy line thickness.

### Slashed Zero

This parameter allows you to print the numeral "0" with or without the slash. This option applies to all character sets except OCR-A and OCR-B.

- **Disable** (factory default). Zero is printed without a slash.
- **Enable**. Zero is printed with a slash.

## Page Format

### Margins

- **Left Margin**. Defines where the first print column is located. The left margin is specified as the number of characters from the left edge of the form.
- **Right Margin**. Defines where the last print column is located. The right margin is specified as the number of characters from the right edge of the form.
- **Top Margin**. Defines the location of the first print line on the page. The top margin is specified as the number of lines from the top of the form's position.
- **Bottom Margin**. Defines the location of the last print line on the page. The bottom margin is specified as the number of lines from the bottom of the form's position.

## Form Length

Specifies the form length in lines. The maximum form length in lines depends on the current LPI setting; it is equal to the maximum form length in inches multiplied by the current LPI setting. For example, at 6 LPI the maximum form length is 6 LPI x 24 inches = 144 lines.

Only valid form length values will be accepted. If you select a length that is larger than the maximum length for the current LPI, the maximum length will be used. If you need a longer page length, you must first change the LPI.

**IMPORTANT** If the form length is set in lines and you change the LPI, the effective page length changes to the form length in characters divided by the new LPI.

**NOTE:** Receipt of a data stream control code which changes the form length overrides the form length previously specified via the operator panel.

## Form Width

Allows you to input the form width in characters from 1 through 272. The maximum form width in characters depends on the current CPI setting; it is equal to the maximum form width in inches multiplied by the current CPI setting.

Only valid form width values will be accepted. If a width is selected that is larger than the maximum width for the current CPI, then the maximum width will be used. If a larger width value is desired, then the CPI value must be changed first.

Table 12 lists the maximum number of characters that can be printed for a given Characters Per Inch (CPI) setting.

**IMPORTANT** If the form width is set in characters and the CPI is changed, the effective page width is changed to be equal to the form width in characters divided by the new CPI.

Table 12 Form Width

CPI Setting	Maximum Form Width (in characters)
10.0	136
12.0	163
13.3	181
15.0	204
16.7	227
17.1	272

## Define CR Code

The Define CR Code option controls the action of the printer when it receives a Carriage Return code (hex 0D) from the host computer. If this feature is enabled, each time the printer receives a carriage return, it inserts an additional Line Feed code (hex 0A) into the data stream. Do not use this feature if the host computer sends line feeds to the printer.

- **CR = CR** (factory default). No extra line feeds are inserted.
- **CR = CR + LF**. Inserts an extra line feed after each carriage return.

## Autowrap

Defines the printer actions when print data is received past the form width setting.

- **With LF+CR** (factory default). Performs an automatic carriage return and line feed when data is received past the form width.
- **With CR**. Performs an automatic carriage return (without line feed) when data is received past the forms width.
- **Disable** . Discards any data past the form width.

## Define LF Code

Controls the action of the printer when it receives a Line Feed code (hex 0A) from the host computer. If this feature is enabled, each time the printer receives a line feed, it inserts an additional carriage return code (hex 0D) into the data stream. This feature can be used in most installations, but it is required if the host computer does not send carriage returns to the printer.

- **LF = CR + LF** (factory default). Adds an extra carriage return with each line feed.
- **LF = LF**. Does not add a carriage return with a line feed.

## Character Set

This parameter selects a character set for the ANSI emulation. Note that when 0876 OCR-A or 0877 OCR-B is selected as the print language, the Font Attributes Typeface parameter is changed to OCR-A or OCR-B, respectively. Character sets are shown in detail in the *Character Sets Reference Manual*.

## Printer Select

- **ON = DC1/OFF = DC3** (factory default). Disables the printer when a DC1 control code is received, and enables the printer when a DC3 control code is received.
- **Disable**. Ignores the DC1 and DC3 control codes.

## ESC c Sequence

- **Enable** (factory default). An ESC c code received from the host resets the printer parameters to the factory defaults.
- **Disable**. An ESC c code received from the host is ignored.

## Reset Cmd CFG Ld

When the printer receives a host data stream reset command (ESC @ or ESC[K) in addition to resetting printer variables, the selected configuration will be loaded.

- **Disable** (factory default). The active emulation parameters are loaded when the reset command is executed.
- **Power-Up Config**. The power-up configuration is loaded when the reset command is executed.
- **Current Config**. The currently selected configuration is loaded when the reset command is executed.
- **Factory Config**. The factory installed configuration is loaded when the reset command is executed.

## Received CR

- **Observe** (factory default). A CR code received from the host is handled as a carriage return.
- **Ignore**. A CR code received from the host is ignored.

### Received DEL

- **Observe** (factory default). A DEL code received from the host is handled as a Delete command.
- **Ignore**. A DEL code received from the host is ignored.

### Private Mode

Determines the default type of character set (Set 1 or Set 2). This can also be set by ESC sequences ESC [>5h and ESC [>5l. Refer to these descriptions in the *ANSI Programmer's Reference Manual* for further details.

### Pos. on BC/OvrSz

- **Set to top** (factory default). The paper is fed back to the top of barcodes or oversized characters after they are printed. This allows printing on the same line.
- **Set to bottom**. The printer will continue printing without backing up.

### BC Check Digit

- **By host** (factory default). The host calculates the barcode check digit and sends it along with the barcode. The check digit is not verified by the printer but printed as it was received.
- **By printer**. The barcode is sent without the check digit, and the printer calculates and adds it in.

### Barcode Darkmode

- **Enable** (factory default). The barcodes are printed at a higher resolution.
- **Disable**. The barcodes are printed at lower resolution but at a higher speed.

### PUM Default

This is the Unit of Measure (UOM) as it is used within the ANSI emulation. Coordinates received in ESC sequences can be sent in two UOMs:

- **Decipoints** (factory default). A unit of 1/720 inch
- **Lines or columns**. Uses the current LPI and CPI values. The UOM used is determined by this configuration setting.

### Truncate PI Slew

- **Truncate at TOF** (factory default). The slew is terminated when the next Top-of-Form is reached. (This function applies to the ANSI EVFU only.)
- **Disable**. PI slews will be completed independent of their length.

### ETX/ACK

End of Text/Acknowledge. The host controls the flow of communication to the printer by sending a block of data and ending the block with an End of Text (ETX) signal. When the printer receives the ETX signal, it acknowledges the ETX, thereby acknowledging it has received the entire block of data.

- **Disable** (factory default)
- Immediate
- Afterprint



## IGP/PGL Emulation

The PGL emulation is the software based Intelligent Graphics Processor (IGP) for the line matrix family of printers. It is based upon, and is compatible with, the IGP-100/200/400 board using the PGL. The IGP graphics processing features are detailed below.

### Features

**On-Line Form and Label Generation** makes it easy to create forms or labels with a “preprinted” look for each application. IGP programs control all graphic functions, dramatically reducing host computer programming and processing time.

Graphic capabilities include boxes, vertical and horizontal lines with user-selectable thickness, logos, and special alphanumeric print features. Forms and graphic designs can be duplicated horizontally and vertically.

Alphanumeric data can appear as prepositioned “fixed” information (entered when the form is created), be overlaid onto the form (positioned in a specific location after the form is created), or can be dynamically merged with the form.

**Selectable Barcodes** provide you with the appropriate barcode for your application using standard wide-to-narrow ratios. A wide selection of barcodes is available: Code 39, Interleaved 2 of 5, 4-state USPS Intelligent Mail, UPC-A, UPC-E, MSI A through D, Code 128 Subset A, B, and C, EAN/ UCC-128, EAN 8, EAN 13, POSTNET, PostBar, Royal Mail, Datamatrix, and PDF417. UPC and EAN barcodes can specify add-on data.

**Expanded and Compressed Character Print** attract attention where needed. Alphanumeric height and width are controlled independently for a wide range of character sizes up to 113 times the standard character size (up to 11.3 inches wide and tall). Compressed print sizes of 10, 12, 13, 15, 17, and 20 characters per inch (cpi) are available.

**Logos** are created using alphanumeric commands and add many print and shading features for a “customized” appearance to forms, reports, and labels.

**Rotated Alphanumerics** permit new concepts in form design. Normal, expanded, and compressed character strings can be rotated 90 degrees clockwise or counterclockwise, or they can be printed upside down.

**Reversed Print** permits highlighting and contrasting by printing white characters on a dark background.

**Automatic Increment/Decrement Capability** allows batch form processing. Individual alphabetic, numeric, and barcode data fields can be identified and automatically incremented or decremented by any amount, beginning from a specified reference point.

**Scaling Capability** permits graphic elements, such as corners or boxes, to retain their physical shapes and sizes when printed in a horizontal and vertical density other than the base density of 60 x 72 dpi.

**Multinational Character Sets** provide many international character sets, each 96 characters in length. This feature also allows you to create your own character sets using characters defined and stored in memory.

**Extended Character Sets** provide 33 extended character sets, also containing 96 characters in length. These are also stored in memory.

### Configuring the Emulation with the Control Panel

You can select PGL default parameters directly from the control panel or by control codes as explained in the *IGP/PGL Programmer's Reference Manual*. The PGL parameters are described on the following pages. Parameters marked with an asterisk (\*) indicate the default value. The printer must be offline to enter the configuration structure.

Pressing an invalid key to enter a parameter value may move you to another level in the configuration or exit the configuration menu completely. Configure the IGP/PGL according to your specific requirements.

**IMPORTANT** BEFORE you reconfigure the IGP/PGL, print a configuration sheet to see all of the current settings.

## IGP/PGL Submenu

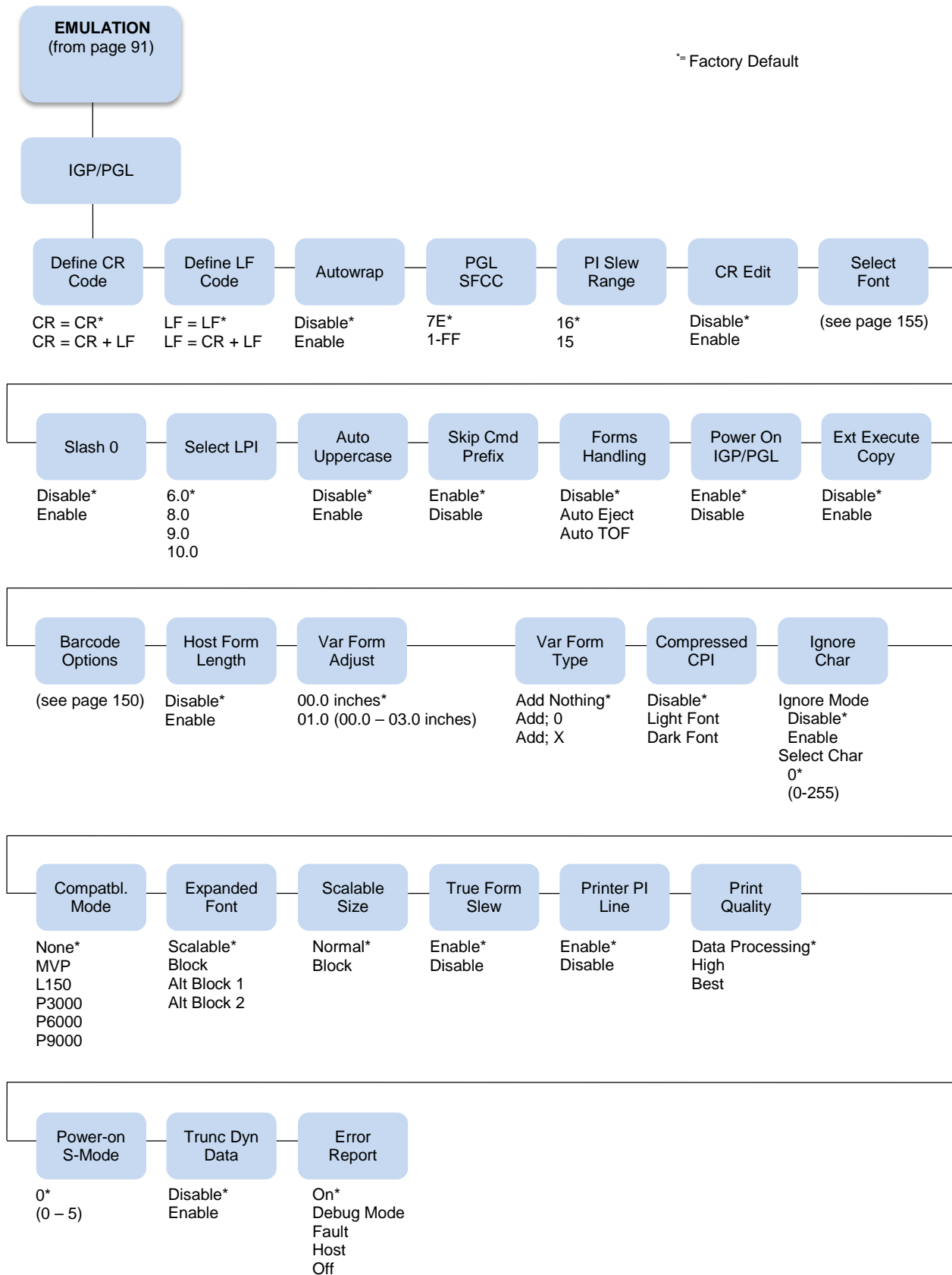

### Define CR (Carriage Return) Code

This parameter forces the printer to insert an automatic Line Feed code into the data stream whenever a Carriage Return code occurs. This is to be used only if the host computer does not send line feeds to the printer.

- **CR = CR** (factory default). Does not perform a line feed. The next print position will be print position 1 of the current line.
- **CR = CR + LF**. Performs an automatic line feed. The next print position will be print position 1 of the next line.

### Define LF (Line Feed) Code

This parameter forces the printer to insert an automatic Carriage Return code into the data stream whenever a Line Feed code occurs. This can be used in most installations, but it is required if the host computer does not send carriage returns to the printer.

- **LF = LF** (factory default). Does not perform an automatic carriage return. The next print position will be the current print position of the next line.
- **LF = CR + LF**. Performs an automatic carriage return. The next print position will be print position 1 of the next line.

### Autowrap

This parameter determines if text will wrap to the next line when the line of text exceeds the right margin.

- **Disable** (factory default). Truncates the text beyond the right margin until a CR or CR + LF is received.
- **Enable**. Automatically inserts a CR + LF after a full print line.

### PGL SFCC

You can specify which hex code (1-255) will be used as the Special Function Control Code (SFCC). The factory default setting is 126. The SFCC denotes that the following data is a PGL command.

### PI Slew Range

You can specify how many lines the paper will feed.

- **16** (factory default). A paper slew of 0-15 will move 1-16 lines.
- **15**. A paper slew of 1-15 will move 1-15 lines. A paper slew of 0 will move 1 line.

### CR Edit

This parameter determines if a carriage return will be followed by a line feed.

- **Disable** (factory default). The printer ignores all carriage returns that are not followed by line feeds.
- **Enable**. The printer processes all carriage returns, even for those that are not followed by line feeds.

### Select Font

Select Font specifies which language is currently selected for use with the PGL. Refer to IGP/PGL Font Set Menu on page 155. for available selections.

### Slash 0

This parameter allows you to print the numeral "0" with or without the slash. This option applies to all character sets except OCR A and OCR B.

- **Disable** (factory default). Zero is printed without a slash.
- **Enable**. Zero is printed with a slash.

### Select LPI

This is the number of lines to be printed per inch. For example, at 6 lpi there is 1/6 inch from the top of one print line to the top of the next print line. The options are:

- **6.0** (factory default)
- **8.0**
- **9.0**
- **10.0**

### Auto Uppercase

This parameter enables the printer to print text in all uppercase when using the ALPHA command.

- **Disable** (factory default). The printer will print text in upper and lowercase.
- **Enable**. The printer will print text in uppercase only.

### Skip Cmd Prefix

This parameter determines if the printer will print any data before a PGL command is received.

- **Enable** (factory default). The printer ignores all data on the current line before an IGP command.
- **Disable**. The printer will print all data on the current line before an IGP command.

### Forms Handling

This submenu allows the user to handle the form in the following ways:

- **Disable** (factory default). No effect.
- **Auto Eject**. Automatically ejects a page at the end of the job to spill out the last page.
- **Auto TOF**. Automatically does a form feed (FF) at the end of each form to the next top of form.

### Power On IGP/PGL

You can set the IGP feature so that it is enabled or disabled when the printer is powered on.

- **Enable** (factory default). The PGL is enabled when the printer is powered on. (The PGL feature is initialized in the Normal mode.)
- **Disable**. The PGL is disabled when the printer is powered on. (The PGL feature is initialized to the Quiet mode.)

### Ext Execute Copy

- **Disable** (factory default). Dynamic data and overlay data are not allowed if the optional Form Count parameter (number of forms to print) is specified as part of the Execute command. (This setting is IGP-100 compatible.)
- **Enable**. Only dynamic data is allowed within a form in which the Form Count parameter is specified in the Execute command. In this case, the exact same form (with identical dynamic data, etc.) is printed for the Form Count. However, incremental data is not incremented since the page that is printing is exactly the same. Also, each form is printed on a separate page.

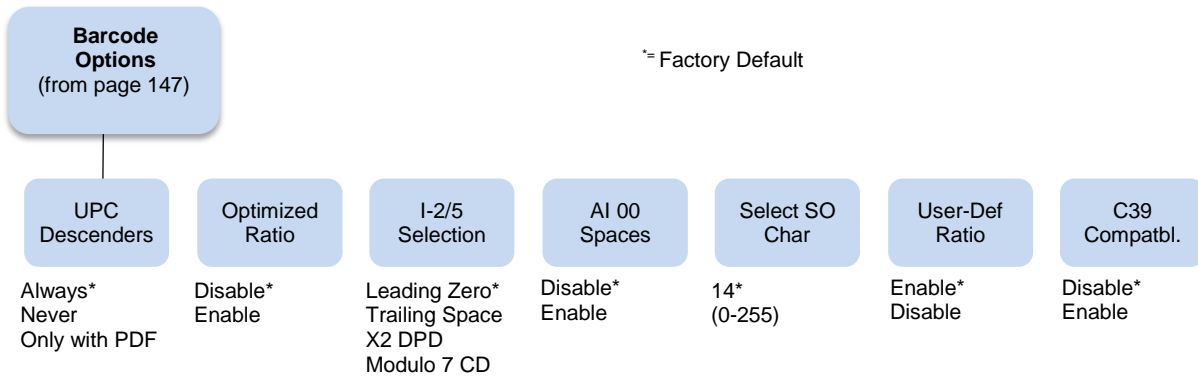

## Barcode Options

The following sub-options help define specific options regarding barcode printing.

### UPC Descenders

This parameter allows you to print barcode descenders when human readable data is not present in the UPC/EAN barcodes.

- **Always** (factory default). UPC/EAN barcodes are printed with descenders, even if there is no human readable data.
- **Never**. UPC/EAN barcodes are printed without descenders if there is no human readable data.
- **Only with PDF**. UPC/EAN barcodes are printed with descenders only when the PDF command is present.

### Optimized Ratio

This option selects different barcode ratios for certain barcodes including Code 39 and I-2/5. It is included for compatibility with the IGP-X00 printers.

- **Disable** (factory default). Use standard barcode ratios.
- **Enable**. Select the alternate barcode ratios.

### I-2/5 Selection

This option is added to be compatible with a special IGP-X00 customization. Usually, if I-2/5 barcodes have an odd number of digits, a leading zero is inserted in front of the data. However, this special IGP-X00 customization gives you the option of adding a space character at the end of the barcode instead.

- **Leading Zero** (factory default). A leading zero is inserted in front of the printable data field.
- **Trailing Space**. A space is inserted at the end of the printable data field and a zero is encoded with the corresponding space in the end of the barcode.
- **X2 DPD**. When selected, an I-2/5 barcode with an X2 magnification will use the specially configured ratios 3:3:6:5 rather than 3:6:9:12 for compatibility issues.
- **Modulo 7 CD**. The I-2/5 barcode uses a modulo 7 check digit instead of the default modulo 10 check digit.

## AI 00 Spaces

This option is designated for EAN/UCC-128 barcodes whose application identifier (AI) is 00.

- **Disable** (factory default). The printable data field is printed with the AI enclosed in parentheses. This is the standard EAN/UCC-128 format.
- **Enable**. The printable data field is printed with the UCC fields separated by spaces. This option is IGP-X00 compatible.

## Select SO Char

Allows you to specify a decimal code from 0 through 255 to be used in place of SO (Shift Out) as the control code. This allows access for the alternate set of control function characters. See the description of the Code 128 barcodes in the *IGP/PGL Programmer's Reference Manual* for details.

## User-Def Ratio

- **Enable** (factory default). User-defined ratios are accepted for barcodes.
- **Disable**. User-defined ratios are ignored and the magnification X1 is used in its place.

## C39 Compatbl.

This menu makes the old method of decoding C39 alternative character set compatible with the new.

- **Disable** (factory default) Uses the current way of decoding.
- **Enable**. Matches the old method of decoding.

## Host Form Length

Determines whether the form length specified in the CREATE command changes the form length designated in the LP+ menu (see LinePrinter Plus Emulation (ASCII, Indian Language) on page 102) when the form is printed by the EXECUTE command.

- **Disable** (factory default). The LP+ form length is unaffected by the form being printed.
- **Enable**. The LP+ form length changes to match the length of the PGL form being printed.

## Var Form Adjust

**(Ranges from 0 - 30)**. Default is 0. This menu value is tenths of inches. The value of this menu specifies the amount of distance to add to PGL forms that have variable form lengths. Variable length forms are forms that are defined by using a “;0” in the CREATE statement: ~CREATE;FORM;0. Variable form lengths are defined by the contents within the form - the form is only as long as necessary to print the form. Changing this menu value adds additional lengths to the form (in tenths of inches). Again, this only applies to forms that use the “;0” variable length forms.

## Var Form Type

This menu option applies only to the host command, CREATE;NAME or CREATE;NAME;DISK. The host command CREATE;NAME followed by ;0, ;X or a form length number will always override the menu option.

- **Add Nothing** (factory default). No action.
- **Add; 0**. When selected, the form length ends at the longest printed element. Same as CREATE;NAME;0.
- **Add; X**. When selected, the form length is the same as the physical page length.

## Compressed CPI

This parameter allows you to choose a compressed character (60% shorter) for 17 or 20 cpi instead of the normal height character.

- **Disable** (factory default). The PGL does not use compressed 17 or 20 cpi font.
- **Light Font**. Uses the standard compressed 17 or 20 cpi font.
- **Dark Font**. Uses a darker compressed 17 or 20 cpi font compatible with the IGP-X00 printers.

## Ignore Char

- **Ignore Mode**

This parameter instructs the PGL to ignore the character selected under the Select Character menu.

- **Disable** (factory default). The PGL does not ignore any characters.
- **Enable**. The PGL ignores the characters specified in the Select Character menu.

- **Select Char**

Instructs the PGL which decimal character (0-255) to ignore from the host.

## Compatbl. Mode

This option instructs the PGL to behave similarly to older versions of the IGP with respect to certain commands.

All new users with new applications should select the “None” option. Selecting this mode insures the printer will behave as described in this manual.

When replacing an older product operating with an existing application, especially those using the PMODE and SMODE commands, you may need to select a compatibility mode. In this case, select the printer model number option that most closely matches the printer being replaced. The Compatibility Mode options include:

- **None** (factory default)
- **MVP**
- **L150**
- **P3000**
- **P6000**
- **P9000**

## Expanded Font

This option defines the type of expanded characters the PGL will select:

- **Scalable** (factory default). These expanded characters have rounded edges.
- **Block**. These are block characters compatible with the IGP-X00 printers.
- **Alt Block 1 / Alt Block 2**. Reserved block sets used only for compatibility purposes.

## Scalable Size

- **Normal** (factory default). Controls the size of scalable characters to be either normal size (as set by the user) or adjusted to match the size of block fonts.
- **Block**. Adjusts the size of scalable characters to exactly match its block font alternative.



### True Form Slew

This option is related to slewing within forms when using the PMODE command. Customers with new applications are advised to keep this option enabled.

- **Enable** (factory default). Form length is accurate according to the form length parameter in the CREATE command.
- **Disable**. Form length is IGP-X00 compatible when using PMODE.

### Printer PI Line

This option enables the IGP to send PI instructions to the printer to slew the form.

- **Enable** (factory default). Send the PI instructions to the printer (LinePrinter Plus) during form slew. This is IGP-X00 compatible.
- **Disable**. Do not send PI instructions to the printer. LFs are sent instead.

### Print Quality

- **Data Processing** (factory default). The emulation prints at 60 x 72 dpi and lets you choose between normal alphanumerics and barcodes and dark mode alphanumerics and barcodes. This mode should be set if you want the highest speed.
- **High**. The emulation prints at 120 x 72 dpi, but all alphanumerics and barcodes are automatically printed in dark mode.
- **Best**. The emulation prints at 120 x 144 dpi and dark mode, which produces a higher resolution, better-looking print image.

### Power-on S-Mode

This option instructs the PGL to behave similarly to older versions of the IGP with respect to certain commands.

All new users with new applications should select "0," the default option. Selecting this mode insures the printer will behave as described in this manual.

Power on S-Mode sets the printer in an SMODE compatibility state at power-up. The default is 0 (disabled, no power-on mode). To use this feature, select a mode from 1 through 5, which puts IGP/PGL in an SMODE state according to the compatibility mode set. If the compatibility mode set is None, then MVP is assumed by default.

For more information, see the *IGP/PGL Programmer's Reference Manual*.

### Trunc Dyn Data

This submenu allows the user to truncate the dynamic data up to the maximum data length specified in Create Mode.

- **Disable** (factory default). If the dynamic data exceeds the maximum data length, an error will report.
- **Enable**. If the dynamic data exceeds the maximum data length, the data truncates.

### Error Report

Sets the error reporting capability for IGP/PGL forms.

- **On** (factory default). Form boundary error checking reported. Any element which falls off the current page is reported as an error.
- **Debug Mode**. The printer is put in debug mode whenever a form is defined in Create Form mode. Each line of the Create Form is printed along with an error if one occurred. This is the same functionality as if there were a slash (/) entered before the Create Form Name.

- **Fault.** When an error occurs, the error is printed and the message “IGP/ PGL ERROR” appears on the printer front panel. The printer then stops printing and goes offline. The error must be cleared before the printer can resume normal operation.
- **Host.** When an error occurs, the error message is sent back to the host.
- **Off.** No form boundary checking. Graphic elements appear clipped if they are beyond the page boundaries.

### **Select Font**

Allows you to choose from various character sets, including IGP/PGL Standard sets, 256 character multinational sets, and UTF-8 encoded Unicode™.

# IGP/PGL Font Set Menu

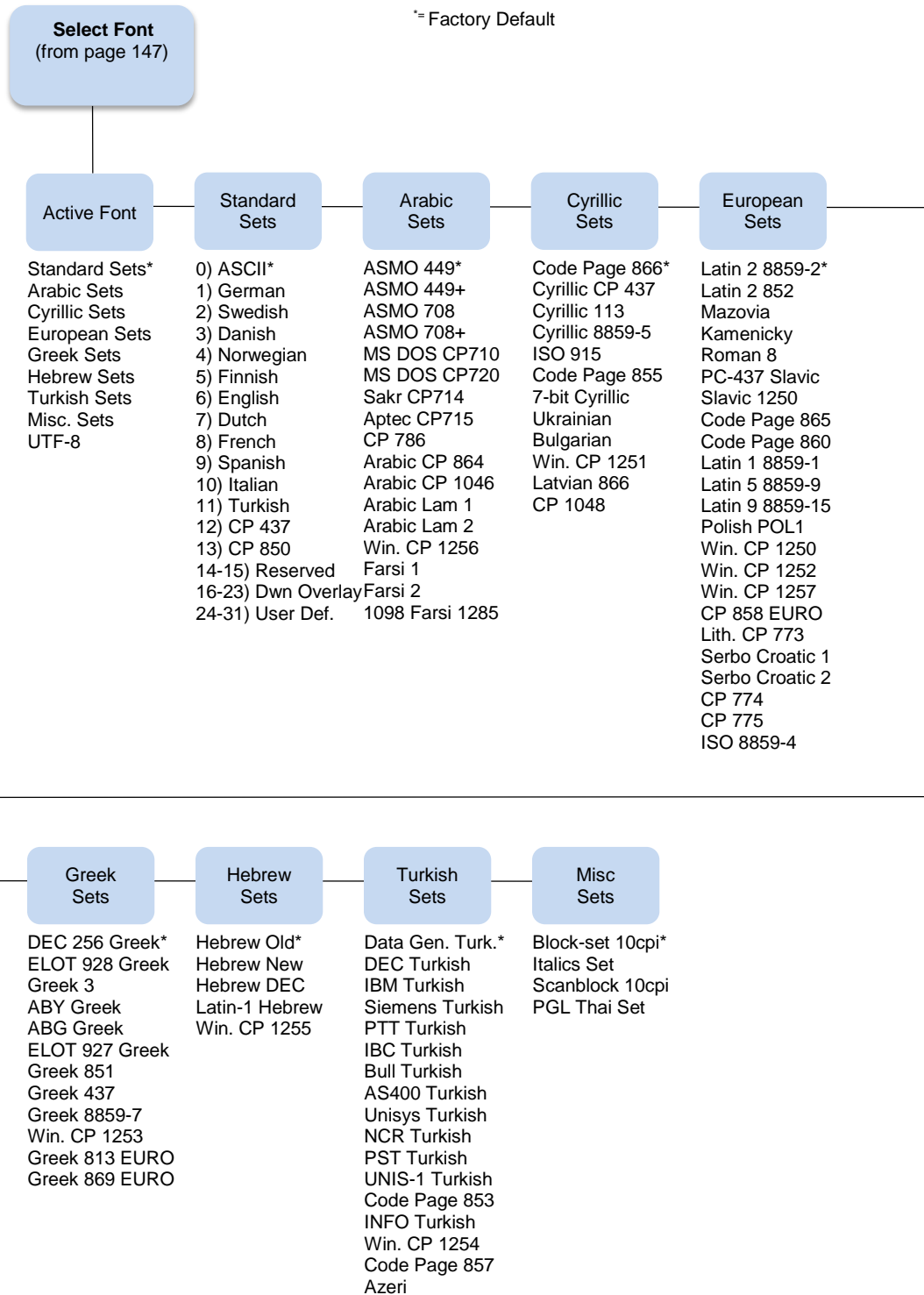

## IGP/VGL Emulation

Code V Graphics language (VGL) is an Intelligent Graphics Printing (IGP) software emulation designed for your Line Matrix printer. The IGP Code V emulation of the QMS® Code V Version II programming language produces online forms, barcodes, and alphanumeric text-generation. The graphics processing features are detailed below.

### Features

**OnLine Form and Label Generation** makes it easy to create forms or labels with the “preprinted” look for each application. VGL programs control all graphics functions, dramatically reducing host computer programming and processing time. Graphics capabilities include boxes, vertical and horizontal, solid and dashed lines with a variety of thickness, logos, and special alphanumeric print features.

**Variable Barcodes** allow the barcode for your application to print with standard or user-defined ratios in vertical or horizontal orientations. Available barcodes are Codabar, Code 39, Code 93, Code 128 with Subsets A, B, and C, and Code EAN/UCC 128, EAN 8, EAN 13, Interleaved 2 of 5, 4-state USPS Intelligent Mail, MSI, UPC-A, UPC-E, POSTNET, PostBar, Royal Mail, and UPC Shipping. POSTNET is available only in the horizontal direction. A dark print mode is included for darker, high-contrast barcodes. The IBARC barcode command prints barcodes in four orientations: horizontal, rotated 90, rotated 180, or rotated 270 degrees.

**Expanded and Compressed Print** draws attention where needed. Alphanumeric height and width are controlled independently for a tremendous range of character sizes up to 9.9 inches wide and tall. Several compressed print sizes are available: 12, 13.33, 15, 17.65, and 20 (dpi), permitting up to 170 columns in an 8.5 inch printed area (20 dpi).

**Rotated Alphanumerics** permit new concepts in form design. Normal, expanded, and compressed character strings can be rotated 90 degrees clockwise, counterclockwise, or printed upside down.

**Logos** are easily created using alphanumeric commands and a variety of print and shading features, which provides a “customized” appearance for forms, reports, and labels. The registered trademark, copyright, TUV®, GS- Mark, UL®, and CSA® symbols are provided as standard designs on the VGL, and you can also define custom symbols.

**Reverse and Shaded Print** permit highlighting and contrasting by printing white characters on a dark background or white characters on a gray, shaded background. Various levels or patterns of gray shading and reverse printing may combine with the many other print features to create distinctive designs.

**Automatic Increment/Decrement Capability** allows batch form processing. Individual alphabetic, numeric, and barcode data fields can be identified and automatically incremented or decremented by any amount, beginning from a specified reference point.

**Standard Character Sets** provide you with many different character sets. Based on the Multinational Character Set, you can create your own character sets using characters defined and stored in flash memory.

### Configuring the Emulation with the Control Panel

You can select VGL default parameters directly from the control panel or by control codes as explained in the *IGP/VGL Programmer's Reference Manual*. The VGL parameters are described on the following pages. Parameters marked with an asterisk (\*) indicate the default value. The printer must be offline to enter the configuration structure.

**IMPORTANT** BEFORE you reconfigure the IGP/VGL, print a configuration sheet to see all of the current settings.

Pressing an invalid key to enter a parameter value may move you to another level in the configuration menu or exit the menu completely.

# IGP/VGL Submenu

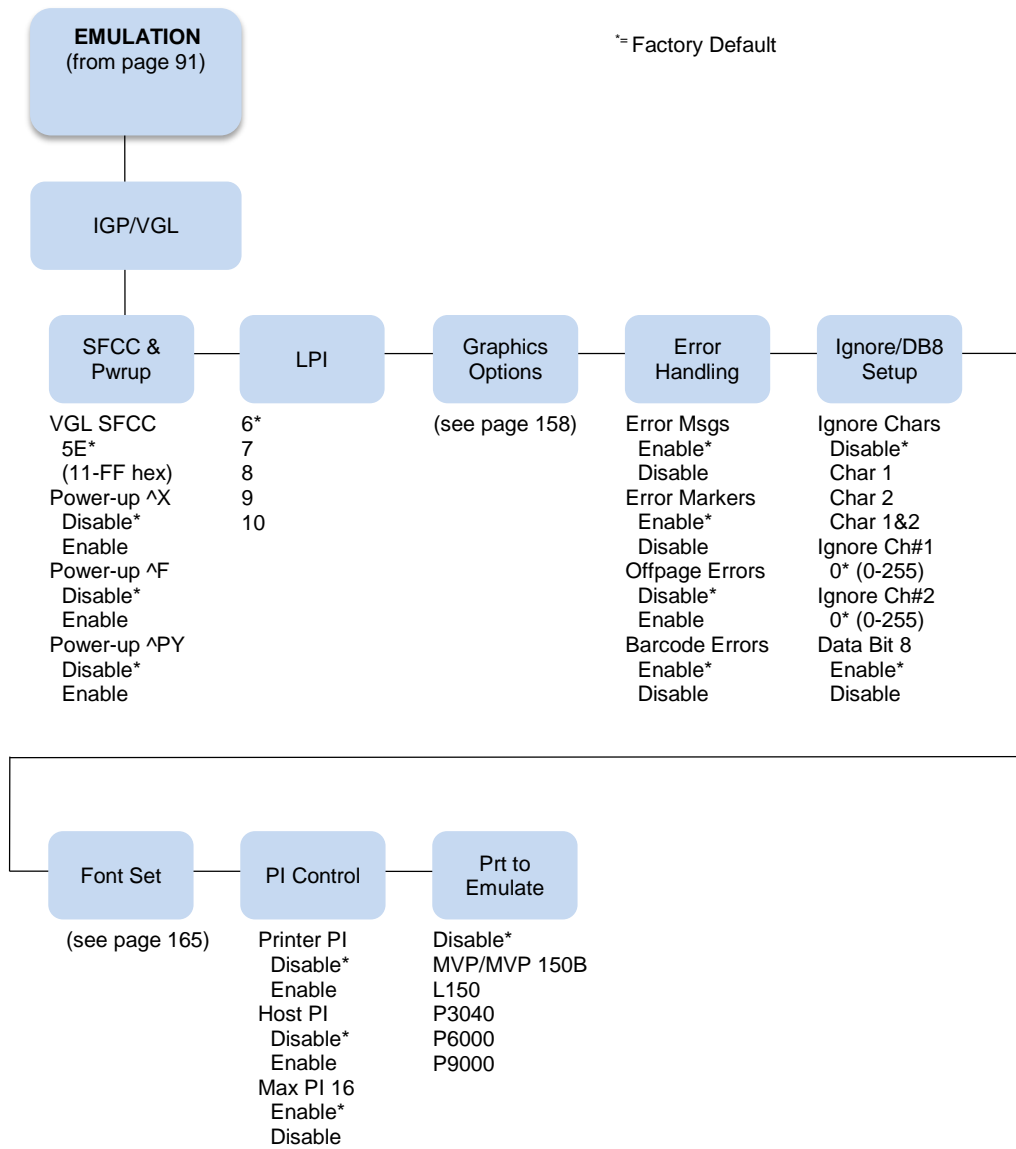

## IGP/VGL Graphics Options Submenu

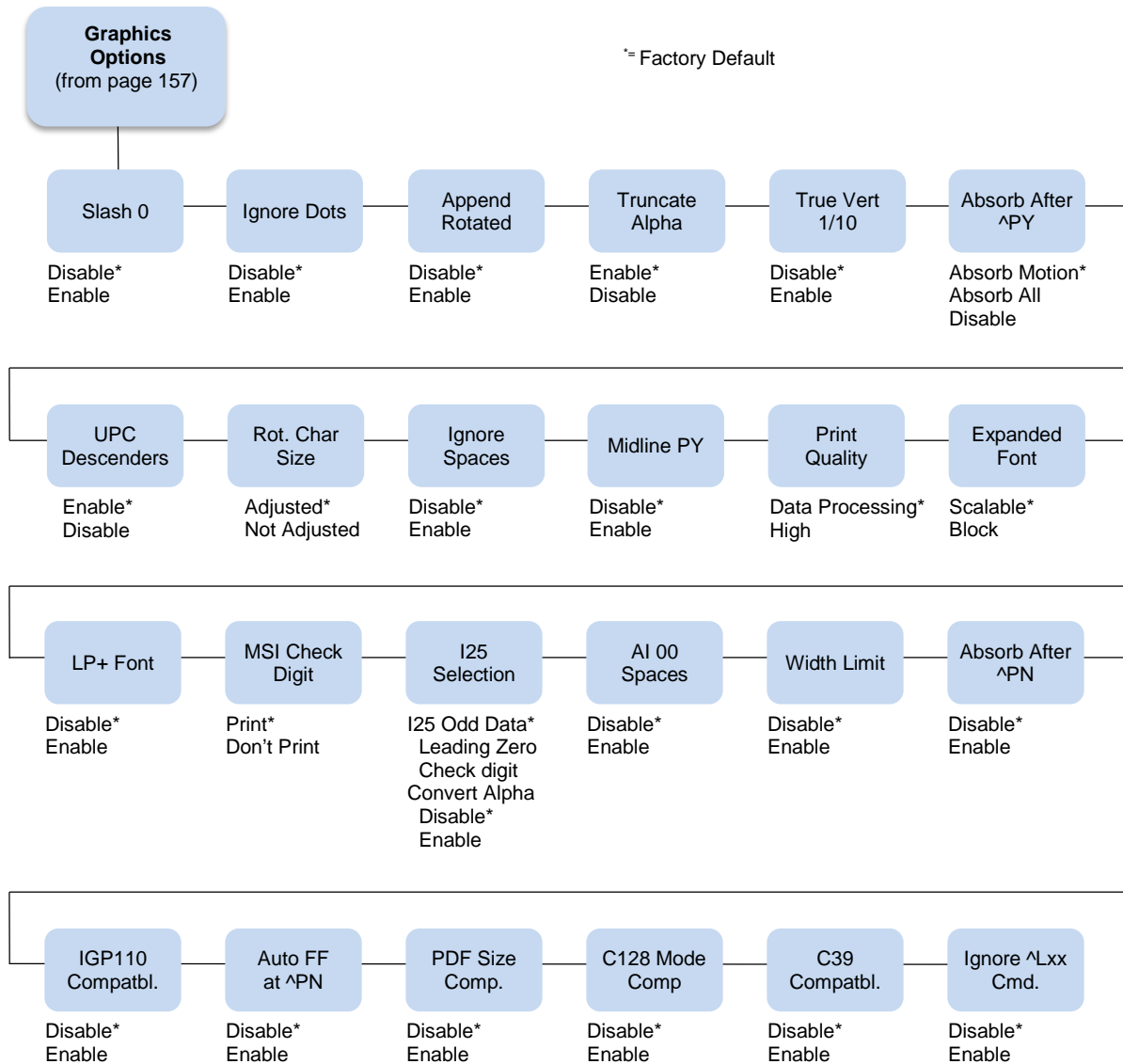

### SFCC & Pwrup

This option has several sub-options which define the SFCC and power-up configuration used with VGL.

#### VGL SFCC

This option selects the Special Function Control Code. The default value 5E. Run a configuration printout to determine the currently selected VGL SFCC.

#### Power Up ^X

- **Disable** (factory default).
- **Enable**. Selects the ignore mode as the power-up default and selects the graphics mode ^PY as the power-up default. All characters are ignored until a ^A command is received.

### Power Up ^F

- **Disable** (factory default).
- **Enable**. Selects free format mode as the power-up default and selects the graphics mode ^PY as the power-up default. Free format causes the VGL to ignore carriage returns, line feeds, and all characters below hex 20 sent from the host.

### Power Up ^PY

- **Disable** (factory default).
- **Enable**. Selects the graphics mode ^PY as the power-up default.

### LPI

The number of lines to be printed per inch. For example, at 6 lpi there is 1/6 inch from the top of one print line to the top of the next print line.

### Graphics Options

The following are several options which configure printing output.

#### Slash 0

This parameter allows you to print the numeral "0" with or without the slash. This option applies to all character sets except OCR-A and OCR-B.

- **Disable** (factory default). Zero is printed without a slash.
- **Enable**. Zero is printed with a slash.

#### Ignore Dots

- **Disable** (factory default).
- **Enable**. Causes the VGL to expect position values to be specified in only 1/10ths of an inch. If the dot position is also given, it is treated as text.

#### Append Rotated

- **Disable** (factory default). Logos and alphanumeric strings are treated as separate elements.
- **Enable**. Appends logos to an alphanumeric string rotated in a clockwise, counterclockwise, or inverted orientation.

#### Truncate Alpha

When enabled, this parameter prevents the printing of Error 48 (Element Off Page Error) if alphanumeric data, including spaces, extends beyond the right side of the form. The options include:

- **Enable** (factory default)
- **Disable**

#### True Vert 1/10

- **Disable** (factory default). A vertical 1/10 of an inch parameter is used as 7/72 of an inch. The absolute move is slightly smaller than expected. For example, a one-inch move would be 70/72 of an inch. Vertical moves that have the same value are identical in length.
- **Enable**. A vertical 1/10 inch parameter is used as 1/10 inch. Rounding occurs to the nearest 1/72 inch. This can cause vertical moves that have the same value to differ by  $\pm 1/72$  inch.

### **Absorb After ^PY**

- **Absorb Motion** (factory default). The first paper motion following a ^PY command is ignored.
- **Absorb All**. The system ignores all the data and terminator until a host generated motion terminator is detected.
- **Disable**. System terminators following a graphics command are sent to the printer and result in paper motion.

### **UPC Descenders**

- **Enable** (factory default). UPC/EAN barcodes are printed with descenders, even if there is no human readable data.
- **Disable**. UPC/EAN barcodes are printed without descenders if there is no human readable data.

### **Rot. Char Size**

- **Adjusted** (factory default). Rotated (clockwise/counterclockwise), expanded characters have a different size than an unrotated character with the same size parameters.
- **Not Adjusted**. Rotated, expanded characters are the same size as unrotated characters with the same size parameters.

### **Ignore Spaces**

- **Disable** (factory default). Trailing spaces are not deleted from the last alphanumeric element in a graphics pass.
- **Enable**. Trailing spaces are deleted from the last alphanumeric element in a graphics pass.

### **Midline PY (includes ^PN)**

- **Disable** (factory default). The Graphics mode Enable command, ^PY, must be the first three characters of a line.
- **Enable**. The ^PY or ^PN can occur anywhere in a line.

### **Print Quality**

- **Data Processing** (factory default). ALPHA text and barcodes are printed in normal mode at 60 x 72 dpi. This mode should be set if the highest speed is desired.
- **High**. ALPHA text and barcodes are printed in dark mode at 120 x 72 dpi.

### **Expanded Font**

- **Scalable** (factory default). These expanded characters have rounded edges.
- **Block**. These are block characters compatible with IGP-X10 printers.

### **LP+ Font**

- **Disable** (factory default). The IGP/VGL uses its default half-dot font, which is slightly different from the standard bitmap font used by LP+ at 12, 13, 15 and 17 cpi.
- **Enable**. The IGP/VGL uses the same font as used by LP+ at all cpi.

### **MSI Check Digit**

- **Print** (factory default). The check digit is appended at the end of the printable data field for MSI barcodes.
- **Don't Print**. The check digit for MSI barcodes does not print.



## I25 Selection

- **I25 Odd Data** (factory default). When an odd number of data is provided, the default setting, Leading Zero, will add a zero to the beginning of the bar code data. The setting, Check Digit, will add a check digit to the end of the bar code data so that the results add up to an even number of data.
- **Convert Alpha**. Disable is the default. When enabled, each non-digit I25 bar code character will convert to "0."

**NOTE:** If you use an Interleaved 2/5 barcode that automatically adds the check digit (type code k or l, IBARC type code INT2/5CD or INT2/ 5CDA), the check digit is added regardless of how this parameter is set.

## AI 00 Spaces

This option is designated for EAN/UCC-128 barcodes whose application identifier (AI) is 00.

- **Disable** (factory default). The printable data field is printed with the AI enclosed in parentheses. This is the standard EAN/UCC-128 format.
- **Enable**. The printable data field is printed with the UCC fields separated by spaces. This option is IGP-X00 compatible.

## Width Limit

- **Disable** (factory default).
- **Enable**. The system will limit the length and width for expanded characters to a limit shown in Table 13, which displays the maximum width allowed for a specific height in the range of 00 through 40 (0.0 through 4.0 inches).

**Table 13 Width Limit Table**

Height Param.	Max. Width Allowed	Height Param.	Max. Width Allowed
00	99	21	51
01	99	22	53
02	3	23	56
03	6	24	58
04	8	25	61
05	11	26	63
06	13	27	66
07	16	28	68
08	18	29	71
09	21	30	73
10	23	31	76
11	26	32	78
12	28	33	81
13	31	34	83
14	33	35	86
15	36	36	88
16	38	37	91
17	41	38	93
18	43	39	96
19	46	40	98
20	48		

### **Absorb After ^PN**

- **Disable** (factory default). All line terminators that follow the ^PN command are sent to the printer and processed.
- **Enable**. The first motion line terminator that follows the ^PN command is ignored.

### **IGP110 Compatbl.**

This option instructs the VGL to behave similarly to the IGP-10 with respect to certain commands. All new users with new applications should select the “Disable” option. Selecting this mode insures the printer will behave as described in this manual.

- **Disable** (factory default). The IGP does not emulate the IGP-10 mode.
- **Enable**. The IGP emulates the IGP-10 version.

### **Auto FF at ^PN**

- **Disable** (factory default). A form feed will not be generated automatically when the ^PN command is encountered.
- **Enable**. A form feed will be generated automatically to slew to the top of the next form when the ^PN command is encountered and when the current vertical position is not at top of form.

### **PDF Size Comp.**

This option is for compatibility of the font size of the barcode printable data field on the old build.

- **Disable** (factory default). Uses the normal font size.
- **Enable**. Matches the font size of the old build.

### **C128 Mode Comp**

The menu is for compatibility of the old build in auto mode switch.

- **Disable** (factory default). Uses auto mode switch.
- **Enable**. Matches the old build on the auto mode switch.

### **C39 Compatbl.**

This menu makes the old method of decoding C39 alternative character set compatible with the new.

- **Disable** (disable). Uses the current way of decoding.
- **Enable**. Matches the old method of decoding.

### **Ignore ^Lxx Cmd.**

- **Disable** (factory default).
- **Enable**. The ^Lxx command will always be ignored.

### **Error Handling**

Following are several options which define how errors are reported.

#### **Error Msgs**

- **Enable** (factory default). Command syntax is checked and error messages printed when command parameters are incorrect.
- **Disable**. Error checking and error messages are suppressed.

## Error Markers

- **Enable** (factory default). Prints the following error markers for those elements that print beyond the page boundaries:
  - >> for elements that begin off the right side of the page;
  - << for elements that begin at the indicated position but end off the page;
  - ◆ for elements where the starting position of the command contains an error other than an off-page error.

## Offpage Errors

- **Disable** (factory default). Does not report errors for elements that start or end beyond the right edge of the page.
- **Enable**. Reports errors for elements that start or end beyond the right edge of the page.

## Barcode Errors

- **Enable** (factory default). An error message will print when invalid barcode data is encountered.
- **Disable**. VGL will not print an error for illegal barcode data; the barcode will be skipped.

**NOTE:** When the Barcode Errors option is disabled, the VGL emulation will try to make the best use of invalid data by either truncating extra digits or adding zeros to the end of barcode data to meet minimum data length requirements for some barcodes. Not all errors will be corrected.

## Ignore / DB8 Setup

Following are several options which define character filtering and Data Bit 8.

### Ignore Chars

- **Disable** (factory default). Character filtering is not enabled.
- **Char 1**. Character 1 will be filtered. Select the option "Ignore CH#1" to specify character 1.
- **Char 2**. Character 2 will be filtered. Select the option "Ignore CH#2" to specify character 2.
- **Char 1 & 2**. Characters 1 & 2 will be filtered. Select the options "Ignore CH#1" and "Ignore CH#2" to specify values for these characters.

### Ignore CH#1

Specifies character 1 for the character filtering option. Valid decimal values are from 0 through 255.

### Ignore CH#2

Specifies character 2 for the character filtering option. Valid decimal values are from 0 through 255.

### Data Bit 8

- **Enable** (factory default). The PI line is not passed directly from host to printer; all 8 bits are used for data bits, and characters in the hex 80-FF range can be accessed.
- **Disable**. When the host PI line is enabled, Data Bit 8 internally indicates PI line status. To use the PI line, disable Data Bit 8, and enable the Host PI configuration option (under the PI Control option, below).

**NOTE:** Data Bit 8 is interpreted as either Data Bit 8 or PI signal, but never both. When enabled as Data Bit 8, Data Bit 8 has priority over the PI signal, and all data above hex 7F is used to access character data and not to interpret PI line data.

Conversely, when Data Bit 8 is disabled and the PI signal is used, Data Bit 8 of the data is reserved for use as the PI function, and you cannot access characters in the hex 80-FF range. Therefore, to access characters in the hex 80-FF range, Data Bit 8 must be enabled.

### **Font Set**

The Font Set specifies which language is currently selected for use with the VGL. Refer to IGP/VGL Font Set Menu on page 165 for available selections.

### **PI Control**

#### **Printer PI**

- **Disable** (factory default). The ASCII emulation is configured with the PI line disabled.
- **Enable**. The ASCII emulation is configured with the PI line enabled.

#### **Host PI**

- **Disable** (factory default). The host does not send PI signals.
- **Enable**. The host sends PI signals. The Data Bit 8 configuration option must be disabled to transmit the PI line to the printer.

#### **Max PI 16**

- **Enable** (factory default). A paper slew of 0-15 will move 1-16 lines.
- **Disable**. A paper slew of 1-15 will move 1-15 lines. A paper slew of 0 will always move 1 line.

### **Prt To Emulate**

This option allows you to select an earlier model printer/IGP board combination to emulate. When a printer emulation is selected, the scaling command causes the printer to generate a graphic image in the same density as the printer emulation chosen. Five types of printers can be emulated: MVP or MVP 150B, L150, P3040, P6000, and P9000. Once a printer emulation is selected, it remains active until the printer is turned off or another printer emulation is selected. All new users with new applications should select the "Disable" option, which insures the printer behaves as described in this manual. The other compatibility modes are required to emulate the behaviors of older printers which may be inconsistent with the documented VGL functionality. Proper use of this feature requires the printer to be equipped with high resolution hammer bank tips (12 mil).

# IGP/VGL Font Set Menu

\*= Factory Default

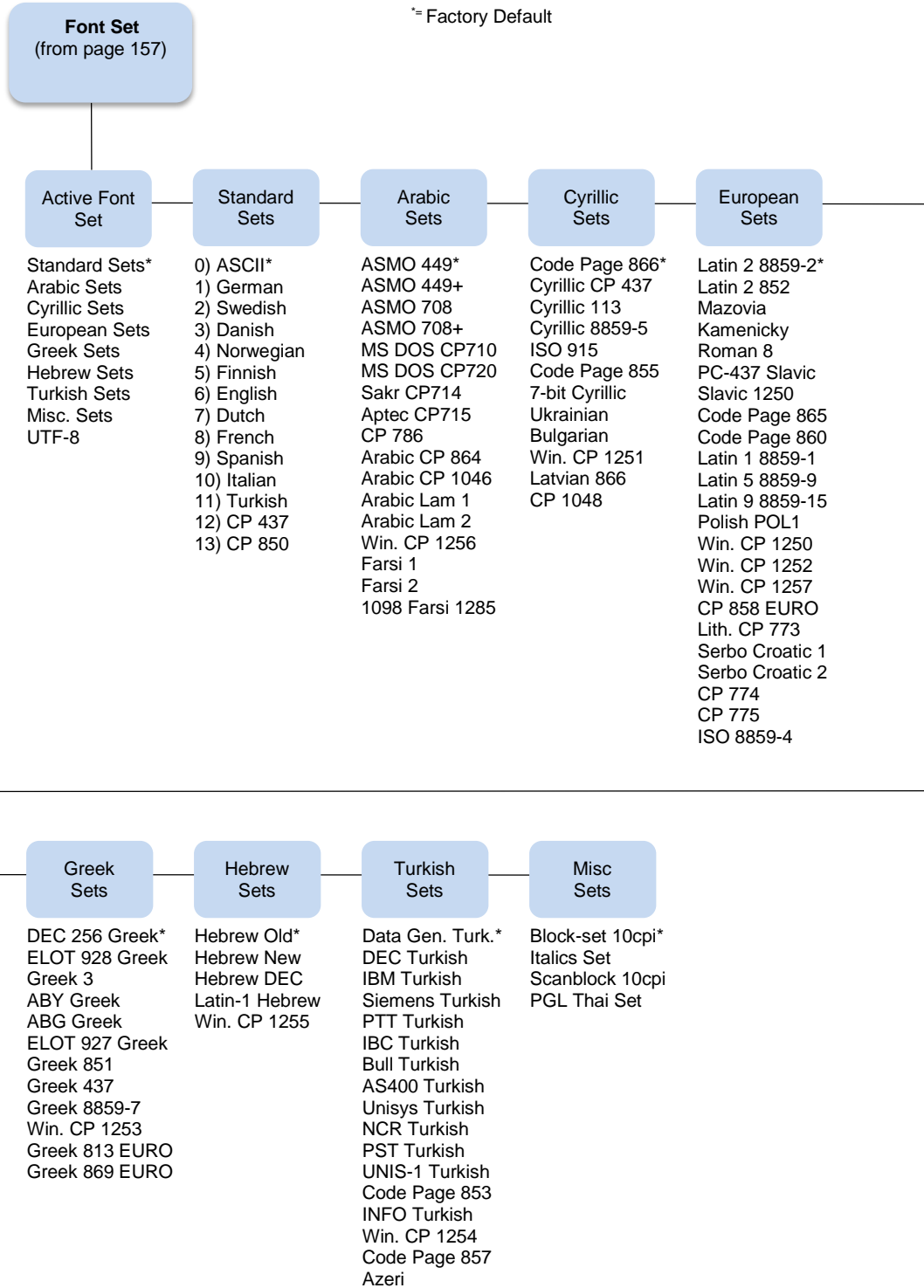

# IPDS Emulation

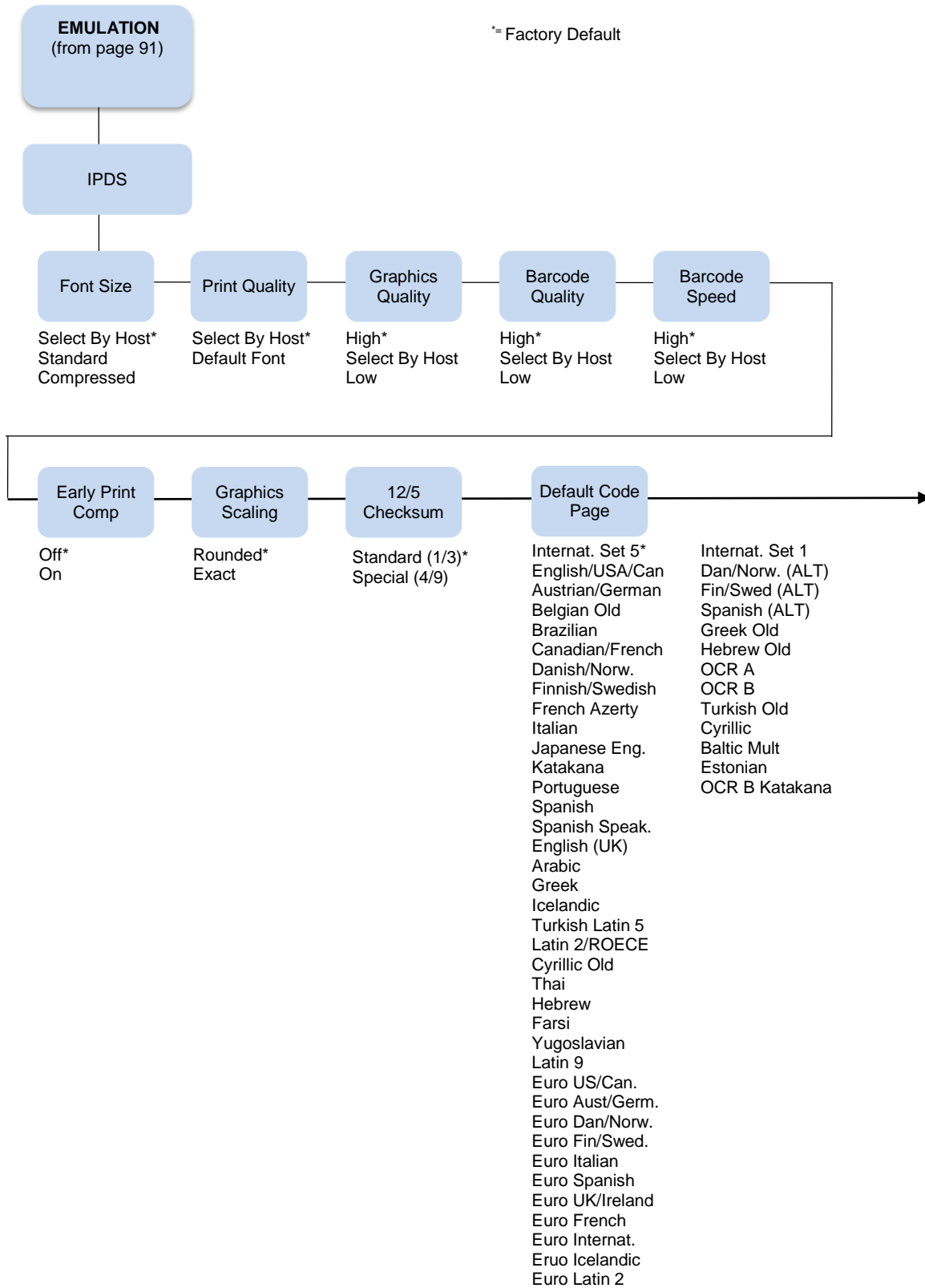

\*= Factory Default

Code Page Subset	Default Font	VPA Check	Hexdump Mode	Print IPDS Fonts	Undef Char Subst	Emulation Mode
Thai Version 0* Version 1 Version 2	DRAFT 10* DRAFT 12 DRAFT 13 DRAFT 15 DRAFT 17 DRAFT 18 DP 10 DP 12 DP 13 DP 15 DP 17 DP 18 NLQ 10 NLQ 12 NLQ 13 NLQ 15 NLQ 17 NLQ 18 OCRA OCRB PSM	Enable* Disable	Disable* Enable		0x60* 0x40 – 0xFE	None* 4234 67xx 64xx/65xx 4224

A general discussion about starting and stopping IPDS can be found in the IBM 4234 Product and Programming Reference Manual (GC31-3879). Sending a non-IPDS data stream to an IPDS printer and vice versa will result in a hung spool file or writer.

### Font Size

This parameter chooses the font size which will be used by IPDS.

- **Select By Host** (factory default). The font ID is only affected by host commands.
- **Standard**. The font ID is converted to a decompressed font ID.
- **Compressed**. The font ID is converted to a compressed font ID.

### Print Quality

This parameter chooses the print quality.

- **Select By Host** (factory default). The application decides the print quality.
- **Default Font**. The default font the printer uses.

### Graphics Quality

This parameter chooses the print quality of graphics.

- **High** (factory default). Graphics are printed at 144 dot rows per inch.
- **Select By Host**. The application decides the quality of the graphics.
- **Low**. Graphics are printed at 72 dot rows per inch.

### **Barcode Quality**

This parameter chooses the horizontal print quality of barcode labels.

- **High** (factory default). Label is printed at 144 dots per inch.
- **Select By Host**. The application decides the quality of the labels.
- **Low**. Label is printed at 72 dots per inch.

### **Barcode Speed**

This parameter chooses the vertical print quality of barcode labels.

- **High** (factory default). Barcodes are printed with less vertical dots, increasing printing speed, but decreasing print quality.
- **Select By Host**. The application decides the quality of the labels.
- **Low**. Barcodes are printed with more vertical dots, decreasing printing speed, but increasing print quality.

### **Early Print Comp (Complete)**

This parameter chooses when to send a Print Comp to the controller.

- **Off** (factory default). Print Comp is sent if page is printed completely.
- **On**. Print Comp is sent immediately. The next page will be created. This improves the print performance when starting the next page.

**NOTE:** When Early Print Comp is enabled and an error occurs, you may lose data.

### **Graphics Scaling**

This parameter chooses the scaling factor for graphics when the Mapping Control option of the IPDS Write Graphics Control command is SCALE TO FIT:

- **Rounded** (factory default). Calculations are rounded up in the desired output resolution.
- **Exact**. Graphics will be scaled as accurately as possible.

### **I2/5 Checksum**

This parameter defines the printer checksum calculation method for Interleaved 2 of 5 barcodes.

- **Standard (1/3)** (factory default). The odd numbers will be multiplied by 3 and the even numbers by 1 for calculation of the checksum.
- **Special (4/9)**. The odd numbers will be multiplied by 4 and the even numbers by 9 for calculation of the checksum.

**NOTE:** "Odd" refers to the 1st, 3rd, 5th... character in the barcode, while "even" refers to the 2nd, 4th, 6th... character in the barcode.

### **Default Code Page**

Choose which code page to use with the IPDS emulation.

### **Code Page Subset**

When the Thai code page is selected as the default, either from the front panel or by a host command, you may choose from three different versions.



## Default Font

Choose a font quality and size from the available selections. All fonts in the Default Font menu are available in standard and compressed vertical resolution (see page 166).

## VPA Check

- **Enable** (factory default). The printer checks for dots that fall outside the intersection of the logical and physical pages. If dots fall outside the area, the printer reports an error to the host if the IPDS Exception Handling Control command setting requires error reporting.
- **Disable**. The printer does not report dots outside the valid printable area.

## Hexdump Mode

A hex code printout (or hex dump) translates all incoming data to hexadecimal equivalents. A hex dump lists each ASCII data character received from the host computer, together with its corresponding two-digit hexadecimal code. Hex dumps can be used to troubleshoot some types of printer data reception problems.

## Print IPDS Fonts

This feature allows you to print a list of all resident fonts currently available in the active IPDS emulation

## Undef Char Subst

Specifies the replacement character to print in place of any unprintable character that is received by the host.

- 0x60 (Factory default)
- 0x40 - 0xFE

## Emulation Mode

Specifies the printer model to emulate.

- None (Factory default) Use this option when a legacy configuration is loaded with PNE.
- 4234 IBM 4234
- 67xx Decision Data 67xx
- 64xx/65xx IBM 6400 / 6500 Series
- 4224 IBM 4224

# PCL – II Emulation

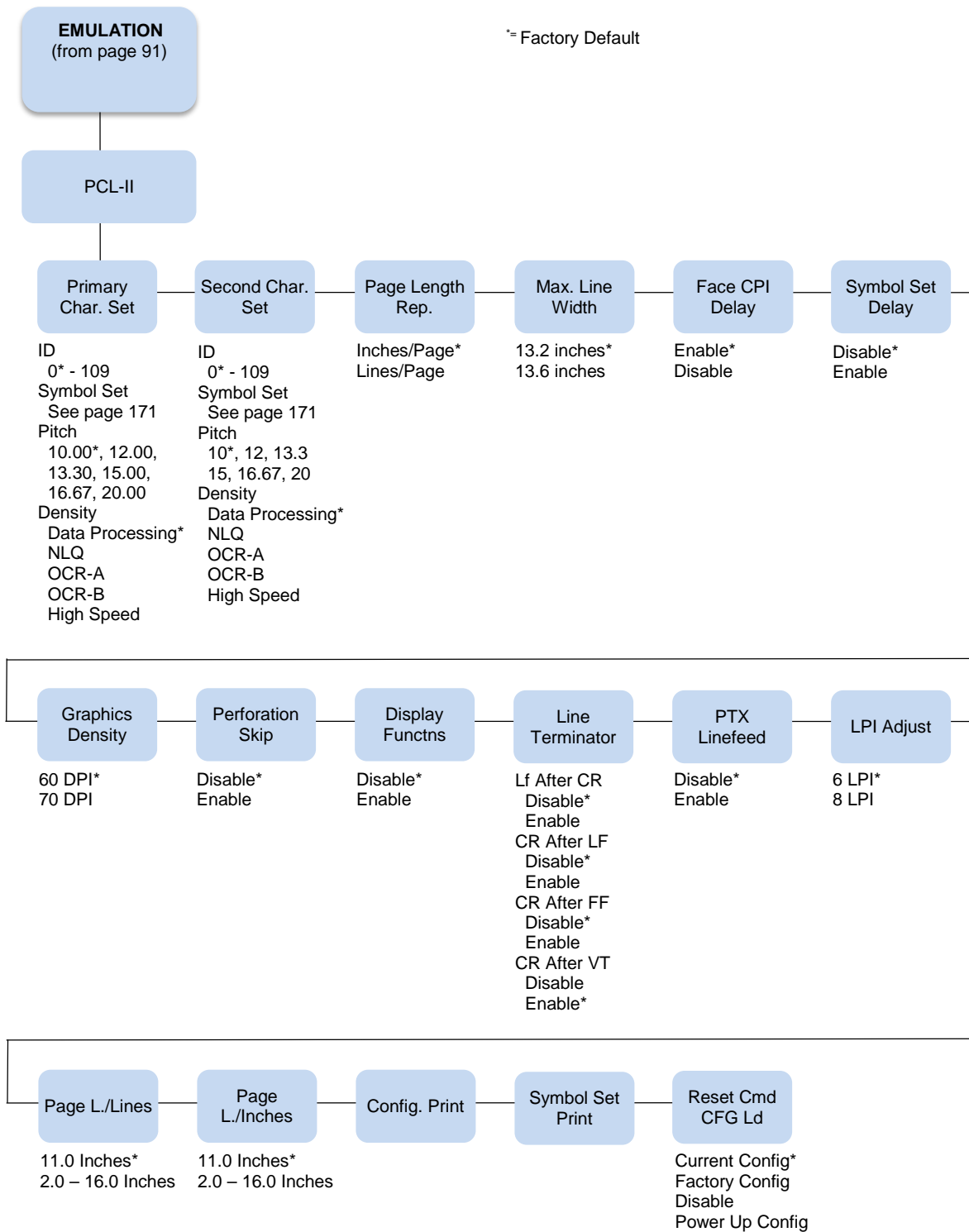



## Primary Char. Set

You can select one of 92 pre-defined character sets by ID (although character sets range from 0 - 109, not all sets are available on the LJ500 printer), or you can select pitch, symbol set, and typeface individually. If the combination you choose matches one of the 92 predefined sets, the ID submenu will reflect that selection. If not, the ID menu will display `xxx` to indicate that the current character set does not match a pre-defined set. Set 0 is the default, and its attributes are 10 cpi, Data Processing typeface, and Roman 8 symbol set.

## Second Char. Set

Your printer can store an additional character set. To toggle between them, send the Shift In (Decimal 15, to select the Primary character set) or Shift Out (Decimal 14, to select the Secondary character set).

## Page Length Rep.

- **Inches/Page** (factory default). All page length calculations are based on the inches displayed on the panel.
- **Lines/Page**. All changes in LPI or density will be changed accordingly. The length of the page is the number of lines per inch, or lpi.

For example, if the form in use is 82 lines at 6 lpi, the page is physically 13.67 inches. Since 13.67 inches is not selectable from the Length in Inches menu, change the representation to lines, then set the number of lines to 82. The inches menu will display 13.6 inches although the printer internally keeps the exact form length of 13.67 inches.

## Max Line Width

Set the maximum line width at 13.2 inches (factory default) or 13.6 inches.

## Face CPI Delay

Allows the combination of different font densities on the same line.

- **Enable** (factory default). Different font densities can be used on the same line.
- **Disable**. Only the same font densities are allowed on the same line.

## Graphics Density

Graphics can be printed in 60 DPI (factory default) or 70 DPI.

## Perforation Skip

- **Disable** (factory default). Allows printing on page perforation.
- **Enable**. You may set up a skip-over margin. For example, a skip-over margin of one inch creates a one inch margin at the bottom of the page.

## Display Functions

- **Disable** (factory default). Control characters are not printed.
- **Enable**. Control characters are printed before they get executed. This is a useful debugging tool.

## Line Terminator

You can define the action of the line. Four options are available: LF after CR, CR after LF, CR after FF, and CR after VT. Each of these options may be enabled or disabled independent of one another.

## PTX Linefeed

- **Disable** (factory default). Linefeed is to be performed as calculated from the bottom of the graphics or barcode, thereby disrupting the vertical text alignment.

- **Enable.** The Linefeed moves to the next line as calculated from the Top of Form position, thereby retaining vertical text alignment. When printing graphics or bar codes, you may want to set the PTX Linefeed parameter to Enable to maintain text alignment.

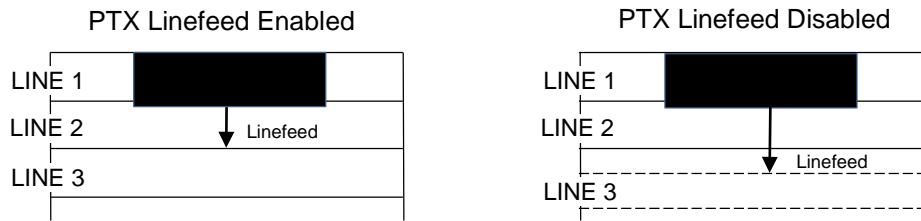

### LPI Adjust

This parameter lets you specify the lines per inch (lpi) values: 6 LPI (factory default) or 8 LPI.

### Page L./Lines

This parameter lets you set physical page length in lines from 12 to 96 at 6 lpi, or 16 to 128 at 8 cpi. The default is 66 lines at 6 lpi.

**NOTE:** If 6 lpi is selected, you will be able to scroll the menu to 128 (an invalid length). However, when you press ENTER to select this value, the menu will return with the maximum lines for 6 lpi (i.e., 96 lines). Similarly, selecting too few lines for 8 lpi will cause the menu to return with 16 lines.

### Page L./Inches

This parameter allows you to set physical page length from 2 to 16 inches, in increments of half an inch. The default is 11 inches.

### Config Print

This option prints the emulation's parameters and the currently selected values.

### Symbol Set Print

This option prints a list of all the available sets. The character set number prints to the left of the character set sample.

### Reset Cmd CFG Ld

When the printer receives a host data stream reset command in addition to resetting printer variables, the selected configuration will be loaded.

- **Current Config** (factory default). If you have preset and presaved multiple configurations, then the currently selected presaved configuration is loaded when the reset command is received.
- **Factory Config.** The factory installed configuration is loaded when the reset command is received.
- **Disable.** The printer ignores the reset command when it is received and continues to use the currently loaded configuration.
- **Power-Up Config.** The power-up configuration is loaded when the reset command is received.

# LG Emulation

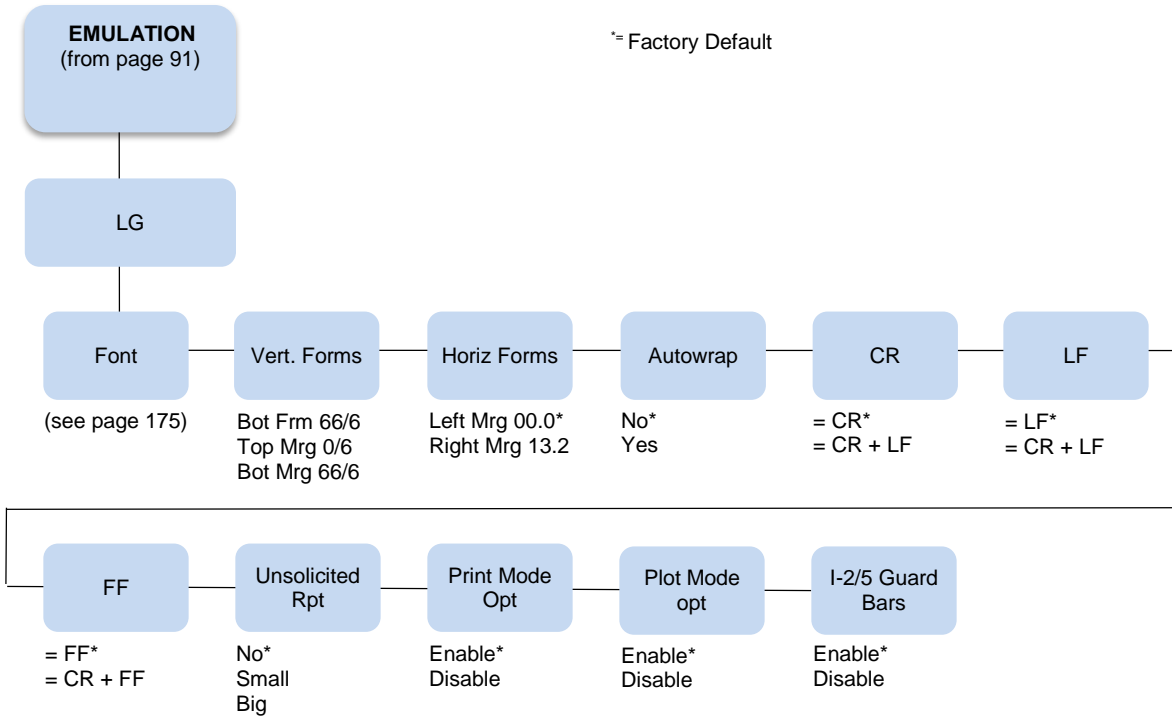

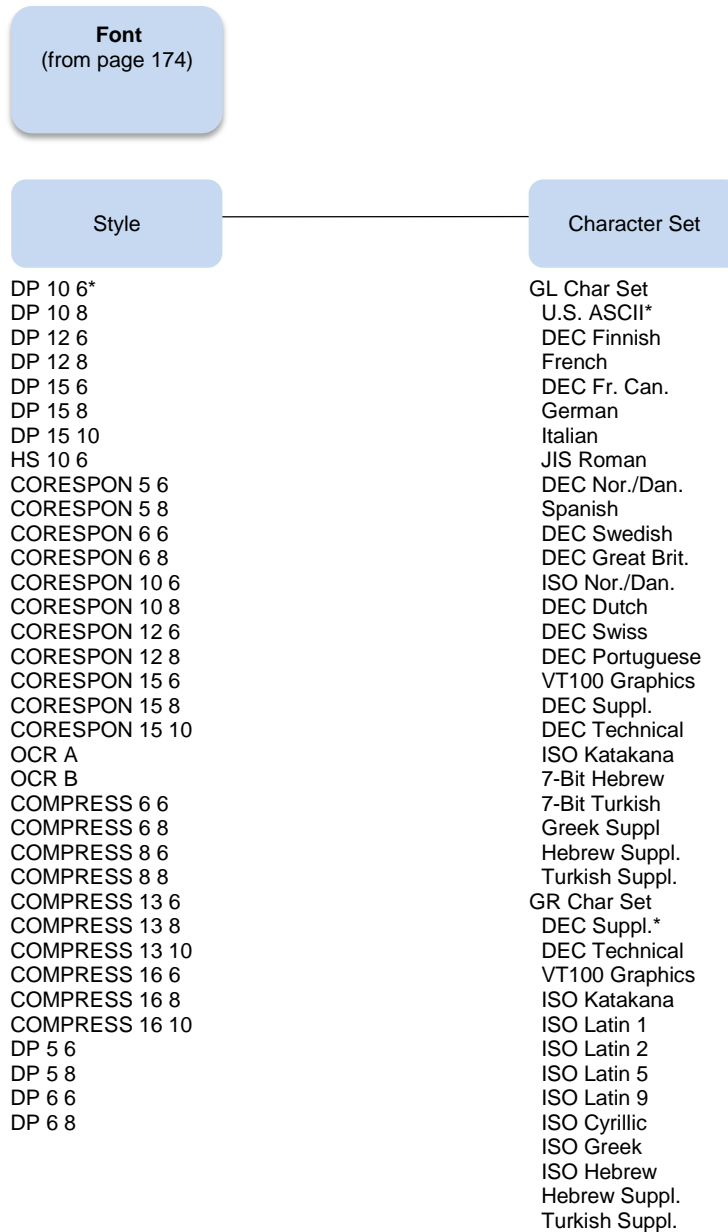

## Font

Select a default font style and character set for the LG emulation, as follows:

- **Style.** This option allows you to specify a print quality that includes a characters per inch (cpi) and lines per inch (lpi) setting, in the format Type cpi lpi. The default setting is DP 10 6 (Data Processing, 10 cpi, 6 lpi). The print quality types you may choose from are as follows:

DP = Data Processing (standard quality)

CORESPON = Correspondence (near letter quality)

COMPRESS = Compressed (vertically compressed for printing long graphs and charts)

OCR A & OCR B = Optical Character Recognition, sets A and B

HS = High Speed (Draft quality for high speed printing)

- **Character Set.** This option allows you to select a character set. The character set you select can be any of the Digital Multinational sets, which include the U.S. ASCII set and several foreign language and special character sets.

## Vert Forms

- **Bot Frm 66/6** (factory default). This option sets the bottom margin for the forms. You must specify the bottom margin in lines (at 6 lines per inch), ranging from 0 to 198 lines (33 inches). The default setting is 66. Press the right arrow to increase the value, left arrow to decrease the value, and ENTER to change units. Selecting a value for this option resets the top margin to 0, so the top margin must be redefined after this option is selected.
- **Top Mrg 6/0**. This option sets the top margin for the forms. You must specify the top margin in lines (at 6 lines per inch), ranging from 0 to 198 lines (33 inches). The default setting is 0. Press the right arrow to increase the value, left arrow to decrease the value, and ENTER to change units. The margins will automatically adjust so that the top and bottom margins do not cross each other.
- **Bot Mrg 66/6**. This option sets the bottom margin for the forms. You must specify the bottom margin in lines (at 6 lines per inch), ranging from 0 to 198 lines (33 inches). The default setting is 66. Press the right arrow to increase the value, left arrow to decrease the value, and ENTER to change units. Selecting a value for this option resets the top margin to 0, so the top margin must be redefined after this option is selected.

## Horiz Forms

- **Left Mgr 0.00** (factory default). This sets the left margin for the forms. You must specify the left margin in 1/10 inch increments, from 0 to 13.1 inches. The default value is 0. Press the right arrow to increase the value, left arrow to decrease the value, and ENTER to change units. The margins will automatically adjust so that the left and right margins do not cross each other.
- **Right Mrg 13.2**. This sets the right margin for the forms. You must specify the right margin in 1/10 inch increments, from 0.1 to 13.2 inches. The default value is 13.2. Press the right arrow to increase the value, left arrow to decrease the value, and ENTER to change units. The margins will automatically adjust so that the left and right margins do not cross each other.

## Autowrap

This parameter determines if text will wrap to the next line when the line of text exceeds the right margin.

- **No** (factory default). Any print data received past the forms width setting is discarded.
- **Yes**. An automatic carriage return and line feed is performed when data is received past the forms width setting.

## CR

This option controls the action of the printer when it receives a Carriage Return code (hex 0D) from the host computer. If this feature is enabled, each time the printer receives a Carriage Return, it inserts an additional Line Feed code (hex 0A) into the data stream. Do not use this feature if the host computer sends line feeds to the printer.

- **= CR** (factory default). Does not insert an extra line feed after each carriage return.
- **= CR + LF**. If this feature is enabled, each time the printer receives a Carriage Return, it inserts an additional Line Feed code (hex 0A) into the data stream. (Do not use this feature if the host computer sends Line Feeds to the printer with each Carriage Return.)

## LF

This parameter forces the printer to insert an automatic Carriage Return code into the data stream whenever a Line Feed code occurs. This can be used in most installations, but it is required if the host computer does not send carriage returns to the printer.

- **= LF** (factory default). Does not perform an automatic carriage return. The next print position will be the current print position of the next line.



- = **CR + LF**. Each time the printer receives a Line Feed, it inserts an additional Carriage Return code (hex 0D) into the data stream. This feature can be used in most installations, but it is required if the host computer does not send Carriage Returns to the printer.

## **FF**

This parameter forces the printer to insert an automatic Carriage Return code into the data stream whenever a Form Feed code occurs. This can be used in most installations, but it is required if the host computer does not send carriage returns to the printer.

- = **FF** (factory default). Does not perform an automatic carriage return. The next print position will be the current print position of the next form.
- = **CR + FF**. Performs an automatic carriage return. The next print position will be print position 1 of the next form.

## **Unsolicited Rpt**

This option enables or disables Printer Device Status Reports to be sent to the host when a reportable status or error condition has occurred.

- **No** (factory default). Disables all unsolicited status reports from the printer.
- **Small**. Enables brief unsolicited status reports and sends an extended status report to the host.
- **Big**. Enables extended, unsolicited status reports and sends an extended status report to the host.

## **Print Mode Opt**

When enabled, this option affects the SPI, SHS, and DECSHORP commands. The printer will no longer be forced into these commands and print speed improves significantly when in portrait orientation. For SHS and DECSHORP, the character size will change with the selected pitch. In addition, SGR attributes such as bold, crossed-out, and italics, will be done in print mode with greater efficiency.

- **Enable** (factory default). Enables the print mode option.
- **Disable**. Disables the print mode option. This provides compatibility with older LG printer products.

## **Plot Mode Opt**

- When enabled, this option will plot with greater efficiency, particularly with respect to the Postnet barcode. Postnet is printed in the same density as the current print mode font so that reverse motion will be inhibited when possible.
- **Enable** (factory default). Enables the print mode option.
- **Disable**. Disables the print mode option. This provides compatibility with older LG printer products.

## **I-2/5 Guard Bars**

- **Enable** (factory default). Horizontal guard bars are printed above and below each Interleaved 2/5 bar code. This option only applies to Interleaved 2/5 bar codes.
- **Disable**. Interleaved 2/5 bar codes are printed normally, with no guard bars.

## **Arabic Context Analyzer**

The Arabic firmware offers outstanding performance in terms of *Arabization* features and is intended for applications requiring Arabic and Latin high print quality under different Arabization platforms. It supports many Arabization mechanisms and many Arabic and Latin code sets.

## Theory of Operation

The Arabic printer is equipped with a built-in front end analyzer that preprocesses all incoming data from a host before it is sent to the LinePrinter Plus emulation. This front-end analyzer has two functions:

1. **Cross-emulation:** Translates all incoming commands from the host to the LinePrinter Plus emulation.
2. **Arabization:** Processes all incoming printable characters from the host and Arabizes them line by line.

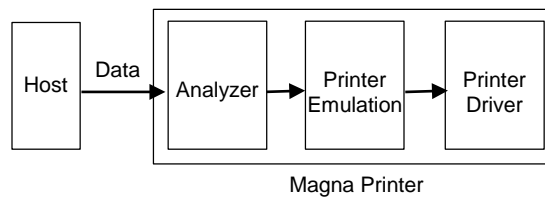

This figure shows the printer shows where the Front End Analyzer resides in the data stream. Data is pre-processed by the Analyzer before it is handed over to the LinePrinter Plus printer emulation.

### Front-end Analyzer Features

- Multi emulation support: ANSI, Epson FX, Epson LQ, HP, C.Itoh, and IBM.
- Multi font support (Naskh, Kofi, Reqa'a,...).
- Multi Arabization Mechanisms: 7-bit with switching codes, 7-bit with escape sequences, 8-bit Pure, 8-bit neutrals, 8-bit with switching codes, and 8-bit with escape sequences.
- 17 Latin code sets.
- 48 Arabic code sets.
- Many configurable Arabization parameters to suit almost any Arabic application available in the market.

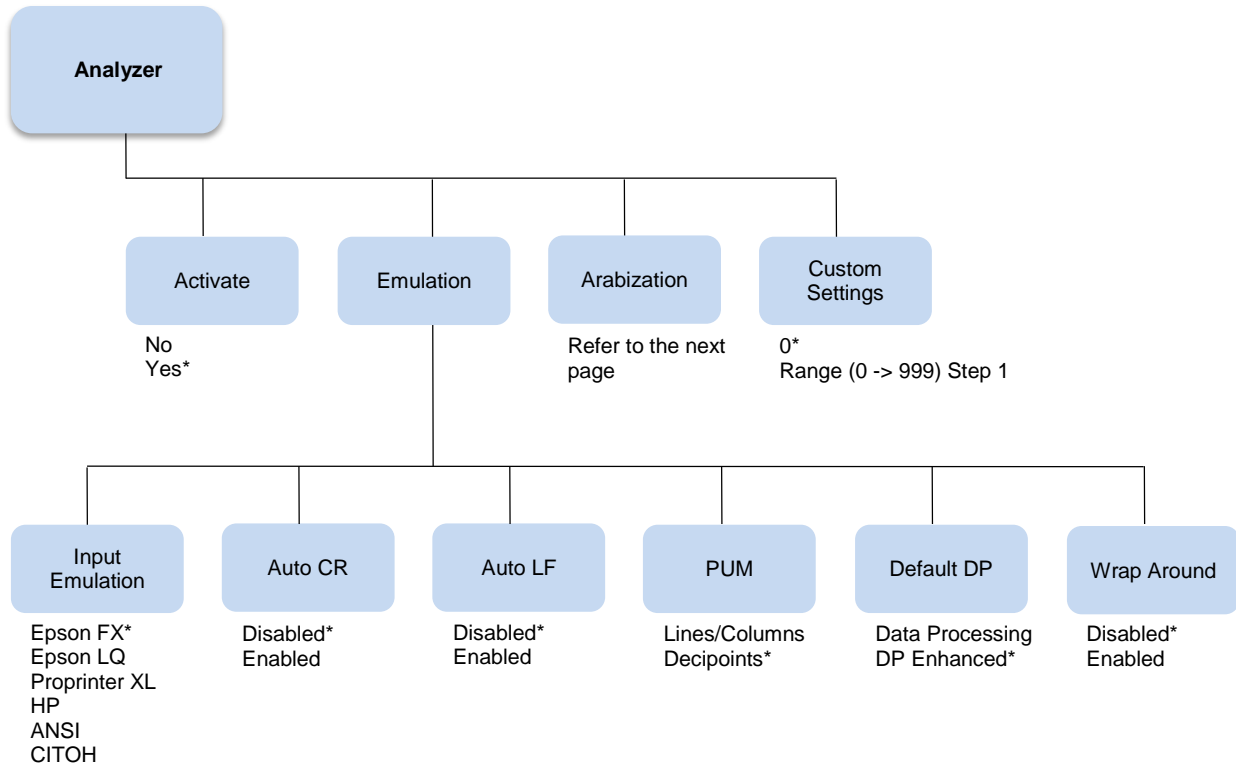

### Analyzer Activate

When the analyzer is deactivated all incoming data from the host is passed directly through the Analyzer to the LinePrinter Plus printer emulation without any processing. The Analyzer only responds to the command: activate analyzer.

- **Yes** (factory default). The emulations under the Analyzer menu are active.
- **No**. The data is passed down to the LinePrinter Plus printer emulation without any modification.

### Input Emulation

Set the input emulation according to the application you are using.

- **Epson FX** (factory default). The Epson-FX emulation.
- **Epson LQ, Proprinter XL, HP, ANSI, CITOH**. Other available emulations.

### Automatic Carriage Return

When Auto CR is enabled, the analyzer sends the printer a Carriage Return each time it receives a Line Feed. The default is Disabled.

**NOTE:** You have to use this item to enable the Auto Carriage Return instead of the menu under the LinePrinter Plus menu as long as the analyzer is active.

### Automatic Line Feed

When Auto LF is enabled, the analyzer sends the printer a Line Feed each time it receives a Carriage Return. The default is Disabled.

**NOTE:** When you want to enable the Auto Line Feed (Auto LF), use the item under the analyzer menu not the one under the LinePrinter Plus menu as long as the analyzer is active.

### **PUM (Position Unit Mode)**

This menu only has an effect when the Analyzer emulation is set to ANSI. It has two different possible values:

- **Decipoints** (factory default). The printer interprets ANSI escape sequence parameters as decipoint values.
- **Lines/Columns**. The printer interprets ANSI escape sequence parameters as line or column counts.

### **Default Data Processing**

Your printer has two “Data Process” typefaces: Normal & Enhanced. This menu item is effective when using the Arabic Windows Driver:

- **Data Processing**. The normal typeface used for Data Processing.
- **Enhanced DP** (factory default). This version of Data Processing typeface is printed at a lower speed than the normal “Data Process” typeface. However, the “Enhanced DP” is a better quality than the normal “Data Process” typeface.

**NOTE:** When using SEDCO Windows printer driver, all menu items under the analyzer are ignored except for this menu item. If the “Printer Font Name” in the driver properties under “Device Settings” is set to “Data Process”, then the value of “Default DP” menu item selects between the “Data Processing” and “DP Enhanced” typefaces.

### **Wrap Around**

When the user sends a long line (longer than what the printer expects) to the printer, the remaining characters will be printed on the next line if the Wrap Around menu item is enabled. If this item is disabled the printer will not print the rest of the line. The default is Disabled.

### **Form Feed Absorb**

When Form Feed Absorb is enabled and a form feed character (0C hex) is received, it will not have an effect. If Form Feed Absorb is disabled, then a form feed character will advance the paper to the next top of form, and move the logical print position to the first character column. The default is Disabled.

### **Custom Settings**

This menu item should be set to zero for normal behavior. To use UTF-8 as your Right Code Set, set the “Custom Settings” to three. The default is Zero.

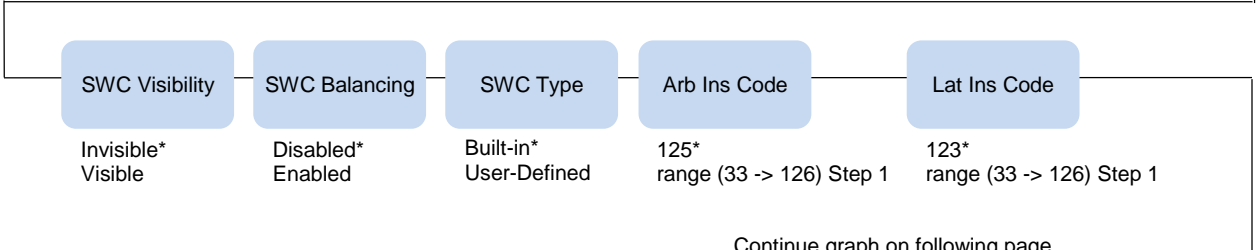
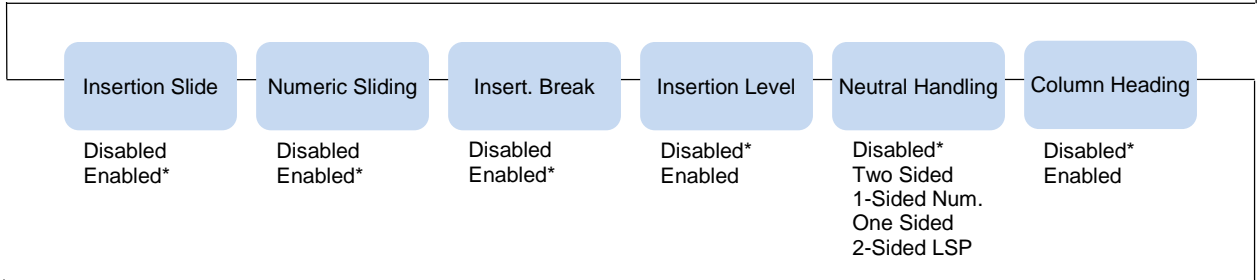
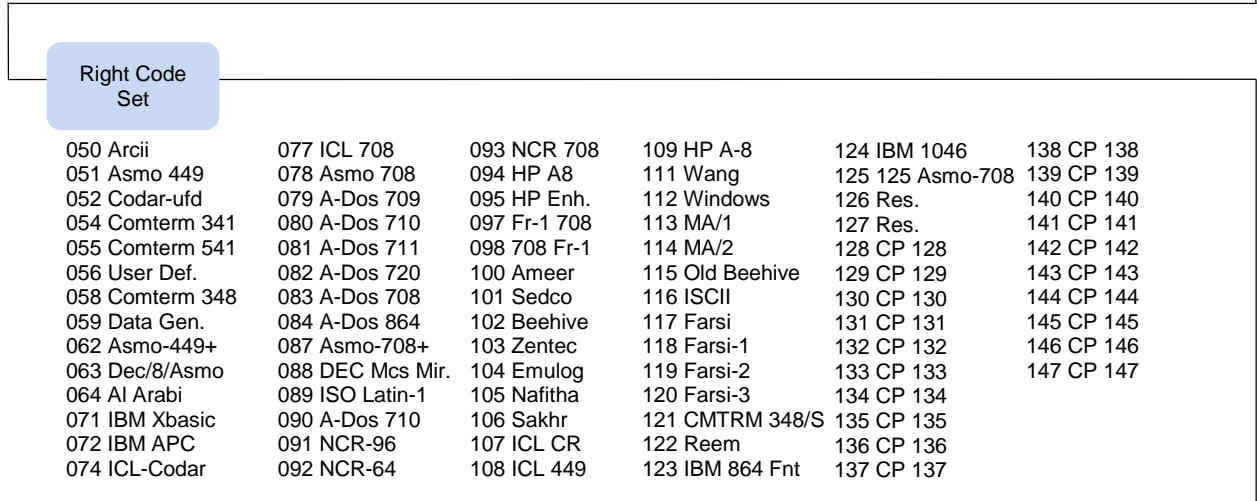
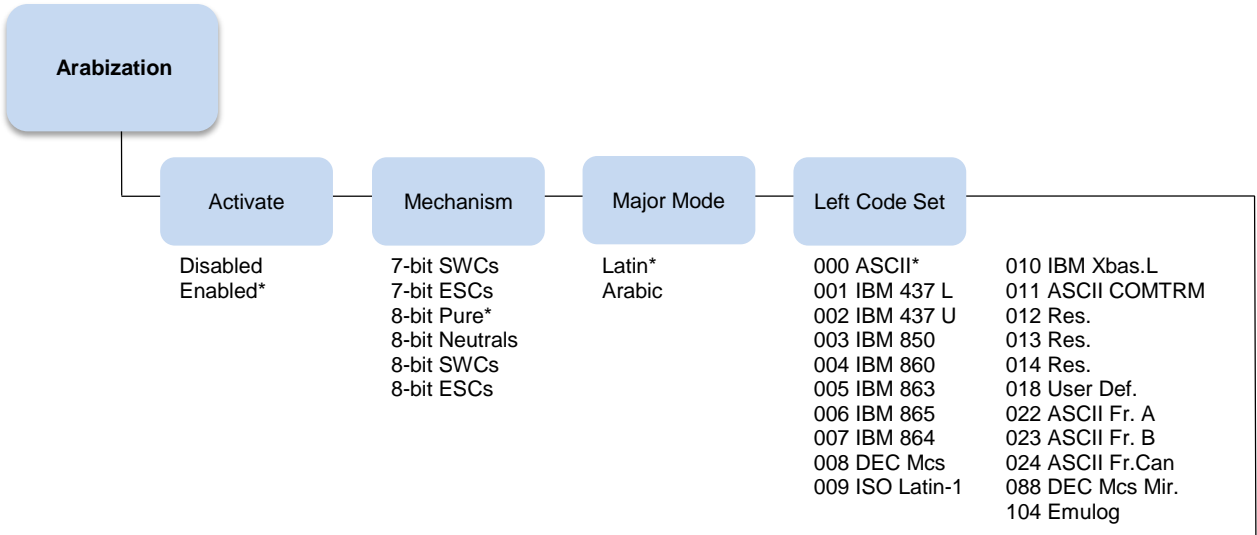





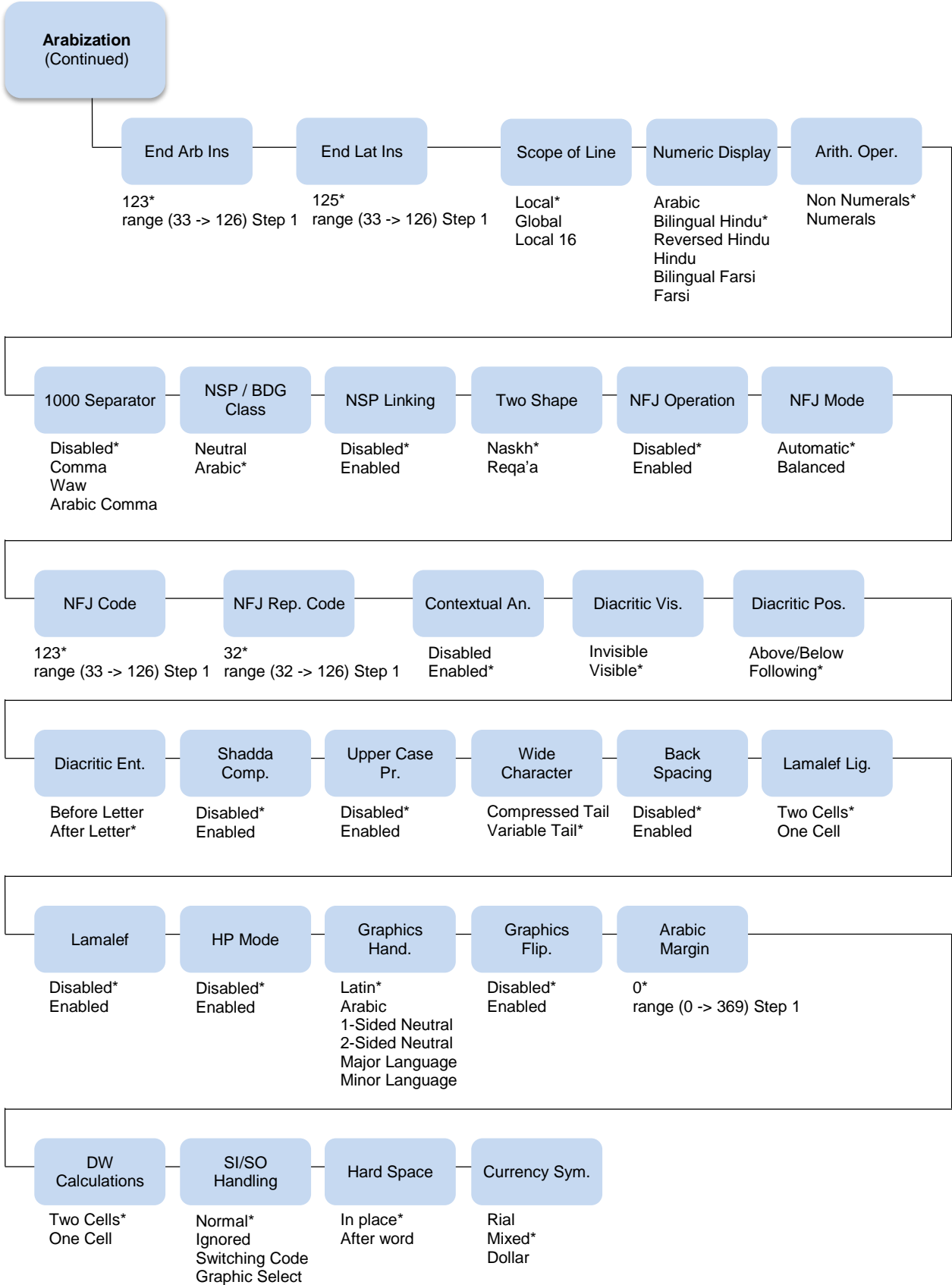



## Arabization Menus

The menus in the Arabization section are equivalent to ESC commands and their options as described in the *Arabic Programmer's Reference Manual*.

## OpenPrint POSTSCRIPT/PDF Emulation

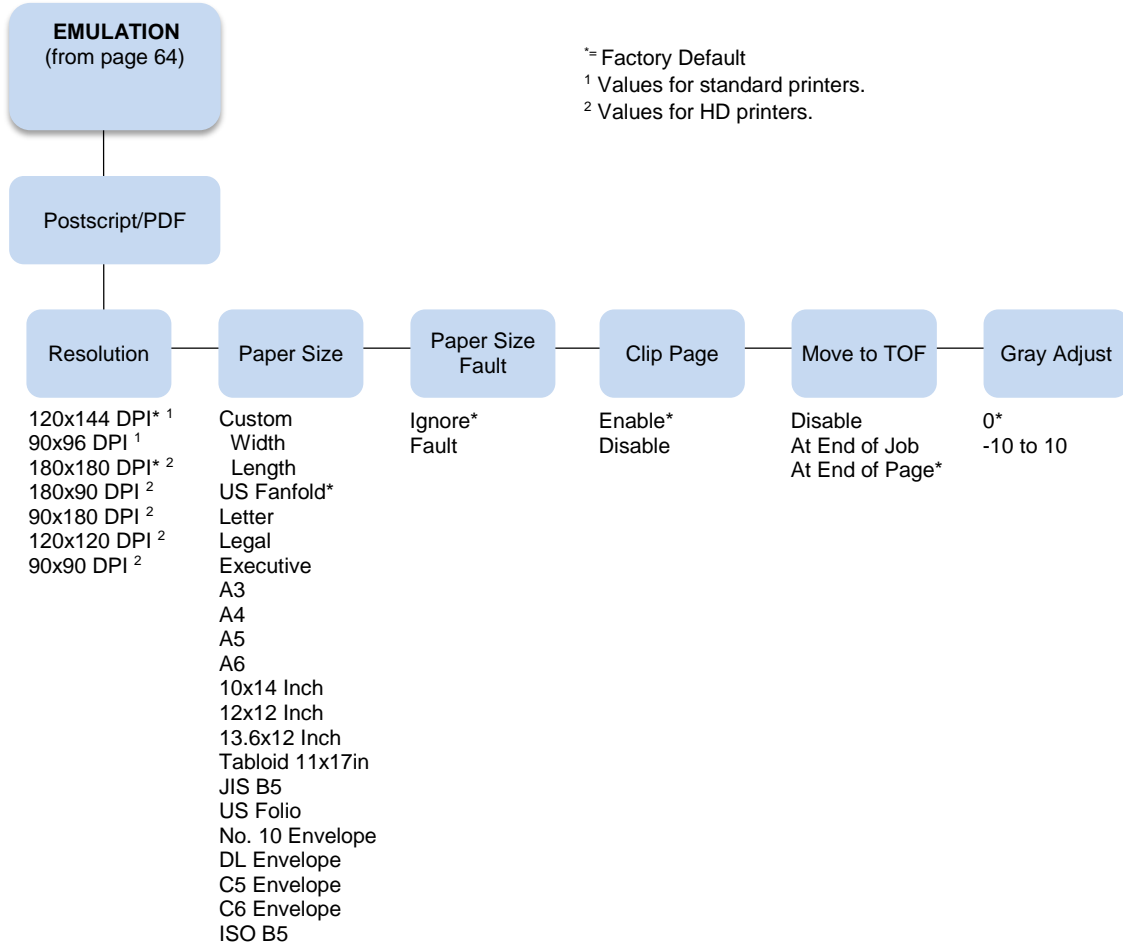

## Postscript/PDF Interpreter

The Postscript/PDF data is handled by Ghostscript by Artifex, an interpreter compatible with the following:

- Portable Document Format (“PDF”) 1.0, 1.1, 1.2, 1.4, 1.5, and 1.6 as defined in the Portable Document Format Reference Manual, distributed by Adobe Systems Incorporated.
- PostScript (TM) Language Level 3, as defined in the PostScript Language Reference Third Edition (ISBN 0-201-37922-8), published by Addison- Wesley in mid-1999.

Ghostscript includes a set of 35 scalable outline fonts in PostScript Type 1 format, compatible in appearance and metrics with the fonts commonly distributed under the following names:

- Bookman (demi, demi italic, light, light italic)
- Courier ((plain, oblique, bold, bold oblique)
- Avant Garde (book, book oblique, demi, demi oblique)
- Helvetica (plain, oblique, bold, bld oblique narrow, narrow oblique, narrow bold, narrow bold oblique)
- Palatino (roman, italic, bold, bold italic)
- New Century Schoolbook (roman, italic, bold, bold italic)
- Times (roman, italic, bold, bold italic)
- Symbol
- Zapf Chancery (medium italic)
- Zapf Dingbats

The Ghostscript version used in the P8000 is 8.71.

## Resolution

This parameter defines the default print resolution. This selection is used when either the print resolution is not defined by the data stream or if the print resolution defined by the data stream is not supported.

The following resolutions are available on OpenPrint P8000 Standard products:

- **120x144 DPI** (factory default)
- **90x96 DPI**

The following resolutions are available on OpenPrint P8000 HD products:

- **180x180 DPI** (factory default)
- **180x90 DPI**
- **90x180 DPI**

- 120x120 DPI
- 90x90 DPI

### Paper Size

This parameter allows selection of available paper sizes. This parameter should be set according to the dimensions of the physical paper installed in the printer. This parameter will be used to determine the TOF and is expected to change when new media is installed. Available options include:

- **Custom.** Sets a user-defined paper size.
  - **Width.** Defines the paper width. The range is 1" to 15" in 0.1 inch increments. The default is 13.6 inches.
  - **Length.** Defines the paper length. The default is 11 inches. Three length options are available:
    - Inches.** Defines the length in inches. The range is 1" to 24" in 0.1 inch increments.
    - 1/6 Inch Lines.** Defines the length in 1/6 inch lines. The range is 6 to 144 lines.
    - 1/8 Inch Lines.** Defines the length in 1/8 inch lines. The range is 8 to 192 lines.

To set a custom length, use the appropriate menu that allows for selection of the exact paper length to avoid loss of top-of-form (i.e., if using a 12" paper, select either the "Inches" menu set to 12" or the "1/6 Inch Lines" menu set to 72. However, if using a 11 2/3 inch paper length, the "1/6 Inch Lines" menu must be used (set to 70) since that is exactly 11 2/3 inches. If the "Inches" menu is used, the closest values would be 11.6 or 11.7 inches which are not exact.

The printer will indicate which of the three length menus was used by showing that submenu first when entering the "Length" menu. The configuration printout will also show the length menu used.

- See Table 5 for paper size options and actual sizes.

**Table 14 Paper Size Options and Actual Size**

Paper Size	Actual Size
US Fanfold	13.6 x 11 in
Letter	8.5 x 11 in
Legal	8.5 x 14 in
Executive	7.3 x 10.5 in
A3	11.7 x 16.5 in
A4	8.3 x 11 2/3 in
A5	5.8 x 8.3 in
A6	4.1 x 5.8 in
10x14 Inch	10 x 14 in
12x12 Inch	12 x 12 in
13.6x12 Inch	13.6 x 12 in
Tabloid 11x17in	11 x 17 in
JIS B5	7.2 x 10.1 in

US Folio	8.5 x 13 in
No. 10 Envelope	4.1 x 9.5 in
DL Envelope	4.3 x 8.7 in
C5 Envelope	6.4 x 9 in
C6 Envelope	4.5 x 6.4 in
ISO B5	6.9 x 9.8 in

**NOTE:** When host jobs have page sizes that do not match the Paper Size parameter, the printer will behave based on the Paper Size Fault, Clip Page, and Move to TOF parameters.

### Paper Size Fault

If a page is sent to the printer with dimensions that do not match the printer, then the following will happen based on the Paper Size Fault menu selected.

- **Ignore** (factory default). The page will print and the paper size length will be ignored. However, the width will be clipped according to the front panel width setting.
- **Fault**. The printer enters a fault state and goes offline. The user will need to either clear the fault and continue, or load new media and change the Paper Size menu selection. Once the printer is back online, printing will resume.

### Clip Page

This menu defines the action when a page is sent to the printer with a length that is longer than the selected paper size length.

- **Enable** (factory default). The page will be clipped at the paper size length. In cases where the sent page is longer than the paper size length, the “Move to TOF” menu setting has no effect since the page is clipped at the TOF position.
- **Disable**. The page will not be clipped and printing continues on the next page. The action taken by the printer when printing of the page completes is determined by the Move to TOF menu.

**NOTE:** Page clipping at paper size width is always enabled to protect against printing on the platen.

### Move to TOF

When the page length given does not match the printer, the printer driver will have to determine how the TOF is kept relative to each page printed. The following menu options are available through the front panel and the driver:

- **Disable**. Only when the FF key is pressed.
- **At End of Job**. After the Current Job.
- **At End of Page** (factory default). After each Page Printed.

### Gray Adjust

This menu adjusts the darkness of the gray elements on the page by gradually reducing or increasing the amount of dots that are placed in the halftone patterns. Pure white and black colors are not affected by setting.

The menu ranges from -10 to +10. The default value is 0.

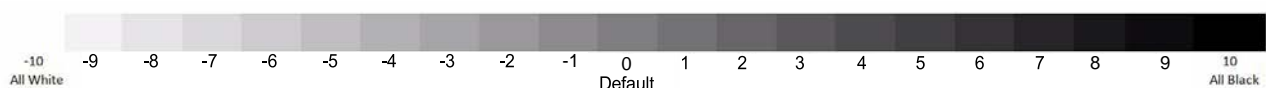



# PRINTER CONTROL Menu

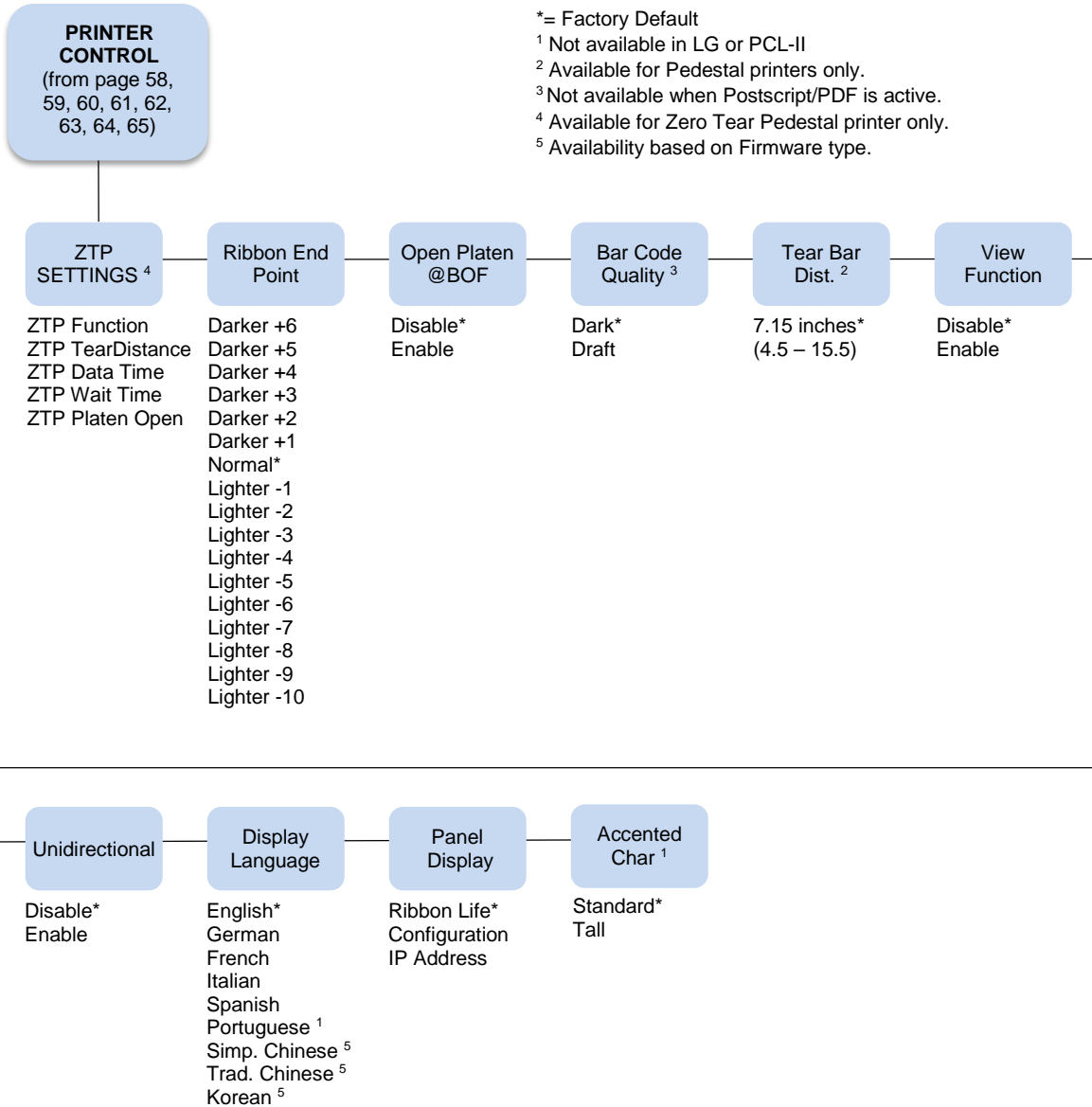

## ZTP SETTINGS

Refer to the ZTP SETTINGS Menu section in Appendix C, page 305. This menu only appears for Zero Tear Pedestal printers.

### Ribbon End Point

This parameter adjusts the point at which the system will declare the ribbon as being expended. The life count will always be from 100% to 0%, but if a darker setting is selected 0% will be reached more quickly. If a lighter setting is selected, the system will extend the time it takes to reach 0%. The range of values are as follows:

- **Normal** (factory default)
- **Darker +1 through Darker +6**
- **Lighter -1 through Lighter -10**

**NOTE:** This value can be adjusted at any time and the display will automatically adjust to show the correct percentage relative to the new end point.

### Open Platen @ BOF (Bottom of Form)

Some special forms have perforation areas that are too thick to pass through the print station. This parameter, when enabled, opens and closes the platen when the perforations move across the platen. When enabling this parameter, you must set the forms length to match the physical distance between perforations.

### Bar Code Quality

Determines the bar code resolution for all emulations, except IPDS. (See IPDS Emulation on page 166 to set the bar code quality for IPDS.)

- **Dark** (factory default). Bar code resolution is set at 120 x 72.
- **Draft**. Bar code resolution is set at 60 x 72.

### Tear Bar Dist. (Distance)

Allows fine and course adjustment of the tear bar position. For printers using the top paper exit, the default (7.15 inches) is used. You can specify 4.5 to 15.5 inches in .01 inch increments to accommodate variations in cover and form design.

### View Function

- **Disable** (factory default for pedestal printers). The View key functionality is Eject only. When the View key is pressed the paper is ejected based on the value of the currently set Tear Bar Distance. When the key is pressed again the top of the next available form moves to the print station. This movement can be either forward or backward depending on the currently set form length.
- **Enable** (factory default for cabinet printers). Enables the View Function in addition to the Eject. When the key is pressed for a short period of time (less than 1/2 second) the functionality is View. The paper moves from the print station to the tractor area for viewing. When the key is pressed again the paper moves back to the print station. When the key is pressed for a longer period of time (more than 1/2 second) the functionality is Eject. When the View key is pressed the paper is ejected based on the value of the currently set Tear Bar Distance. When the key is pressed again the top of the next available form is moved to the print station. This movement can be either forward or backward depending on the currently set form length.

**NOTE:** Default setting is Enable for Indian language printers.

## Unidirectional

The Unidirectional feature affects both print quality and printing speed. By setting this feature, you can configure the printer to print in both directions of the shuttle sweep (bidirectional), or to print in one direction only (unidirectional).

- **Disable** (factory default). The printer will print all data in both directions of the shuttle sweep (bidirectional printing). This choice produces higher printing speed.
- **Enable**. The printer will print all data in only one direction of the shuttle sweep (unidirectional printing). Although enabling this feature reduces print speed, it enhances the vertical alignment of dots and produces cleaner, sharper barcodes and text.

## Display Language

This parameter chooses the language that will appear on the LCD: English, German, French, Italian, Spanish, Portuguese, Simp. Chinese, Trad. Chinese, or Korean. The factory default is English.

**NOTE:** Simp. Chinese, Trad. Chinese, and/or Korean are not available on all firmware versions.

## Panel Display

This menu allows the user to customize the type of information that will display on the panel LCD when the printer is in online mode.

- **Ribbon Life** (factory default). The LCD displays the ribbon life for the current cartridge installed.
- **Configuration**. The LCD displays the configuration that was last loaded.
- **IP Address**. The LCD displays the printer IP Address for networked printers.

## Accented Char

Selects whether the accented characters are standard or tall. See Figure 20 for an example. Selecting tall will slow print speed and may cause the printer to back up during printing.

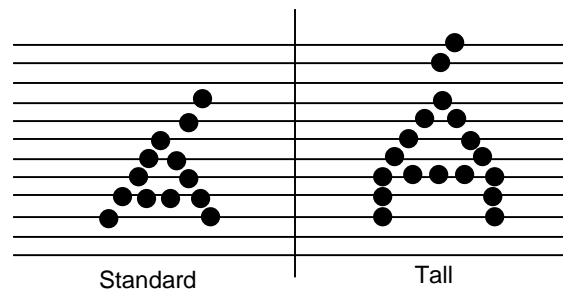

**Figure 20 Accented Characters**

## Slick Paper

Can improve print quality on some slippery media.

- **Disable** (factory default). The printer slews normally.
- **Enable**. Certain slews are slowed to prevent slippage.

**NOTE:** Enabling this menu may slow throughput.



### **Heavy Forms (6H, 8H, and OpenPrint HD Shuttles only)**

Can improve print quality and maintain top of form on certain thick or heavy media.

- **Disable** (factory default). The printer slews normally
- **Heavy 1, 2, 3, 4, 5.** Increasing the Heavy number increasingly slows certain movements to maintain top of form with heavy media.

**NOTE:** The heavy settings may slow throughput.

# ADVANCED USER Menu

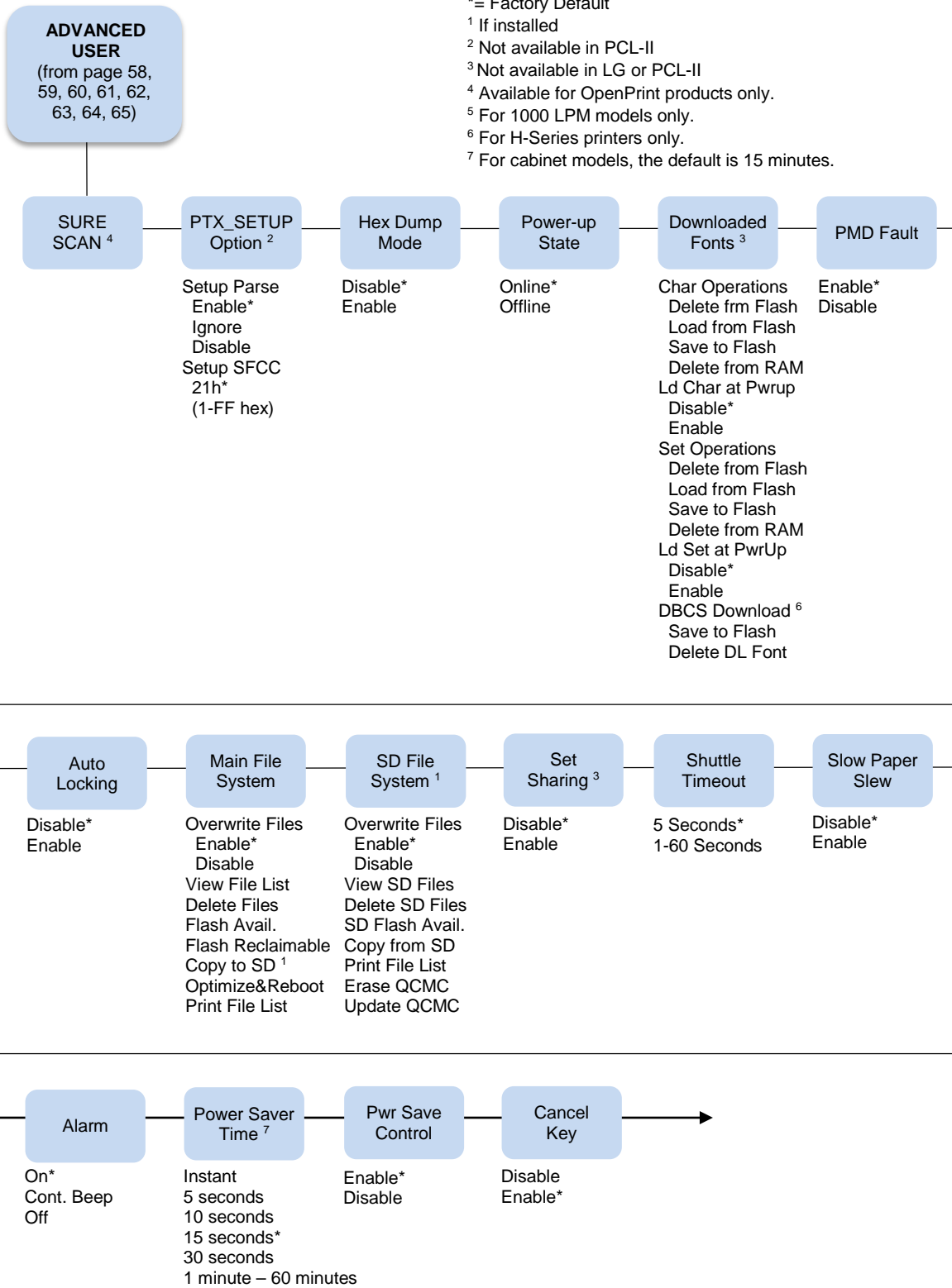

**ADVANCED USER**  
(continued from page 194)

- \*= Factory Default
- <sup>1</sup> If installed
- <sup>2</sup> Not available in PCL-II
- <sup>3</sup> Not available in LG or PCL-II
- <sup>4</sup> Available for OpenPrint products only.
- <sup>5</sup> For 1000 LPM models only.
- <sup>6</sup> For H-Series printers only.
- <sup>7</sup> Available for the ASCII bundle firmware only.

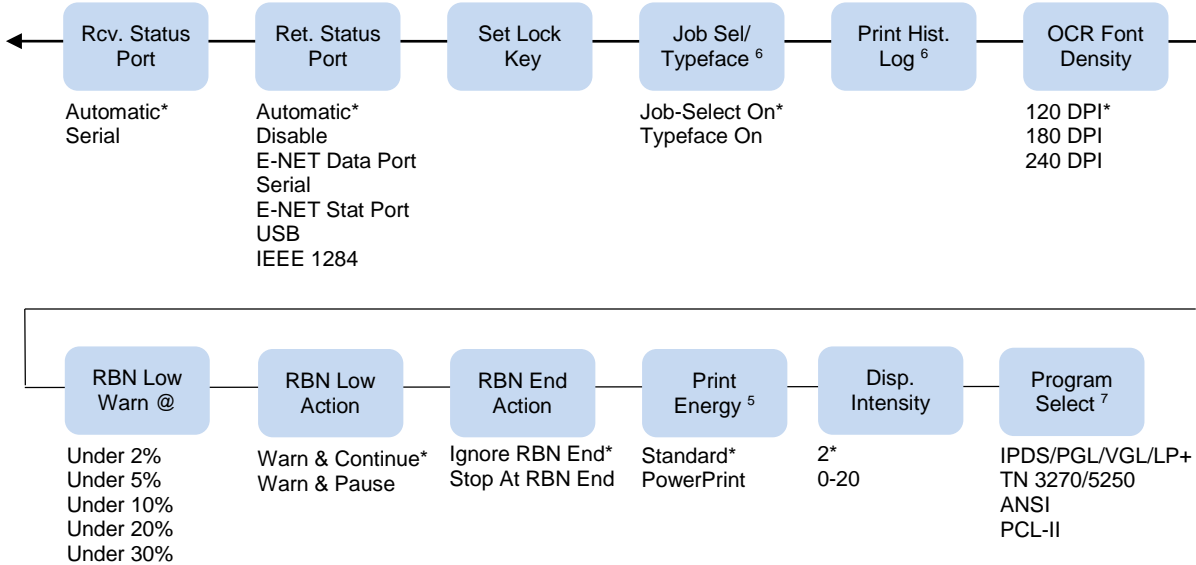

**SURE SCAN Submenu**

**NOTE:** Available for OpenPrint products only. For OpenPrint P8000 Standard Postscript/PDF and OpenPrint P8000 HD Postscript/PDF firmware, the SURE SCAN menu is under the ADVANCED USER Menu (see page 194).

**SURE SCAN <sup>1,2</sup>**  
(from page 64)

- \*= Factory Default
- <sup>1</sup> If installed
- <sup>2</sup> Not available in PCL-II
- <sup>3</sup> Not available in LG or PCL-II
- <sup>4</sup> Available for OpenPrint products only.
- <sup>5</sup> For 1000 LPM models only.
- <sup>6</sup> For H-Series printers only.

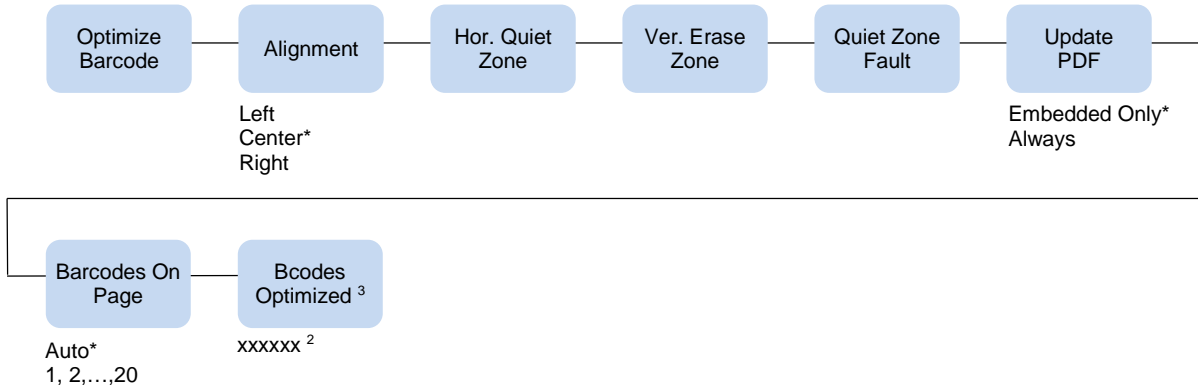

## Optimize Barcode

Defines whether the barcode optimization feature is active.

- **Yes** (factory default). Activates the barcode optimization feature.
- **No**. Deactivates the barcode optimization feature.
- **Test**. Boxes will print around all barcodes that are detected and replaced. This provides a simple method to confirm that the software correctly detects and replaces all the barcodes on any given form.

## Alignment

Defines how the optimized replacement barcode will be positioned with regard to the original barcode position if no obstacles exist to this placement. It defines the first attempted position of the replacement barcode. If the first attempted position causes a replacement barcode to interfere with any other form elements (text, graphics, or dots), the replacement barcode automatically adjusts away from these interfering elements until requested horizontal quiet zones are observed. Selections for this menu are as follows:

- **Left**. The first attempted position of the leftmost bar of the replacement barcode will be the same position as the leftmost bar of the original barcode. For instance, if the replacement barcode is smaller than the original barcode, it will be placed as follows:

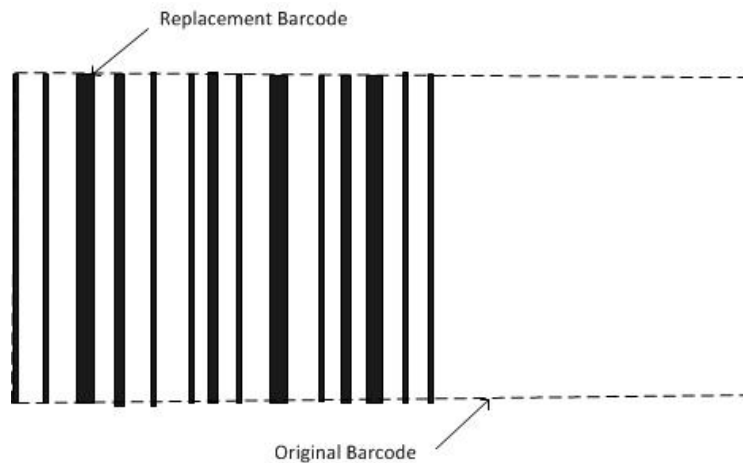

If the replacement barcode is larger than the original barcode, the replacement barcode will begin at the left edge of the original barcode and expand beyond the right edge.

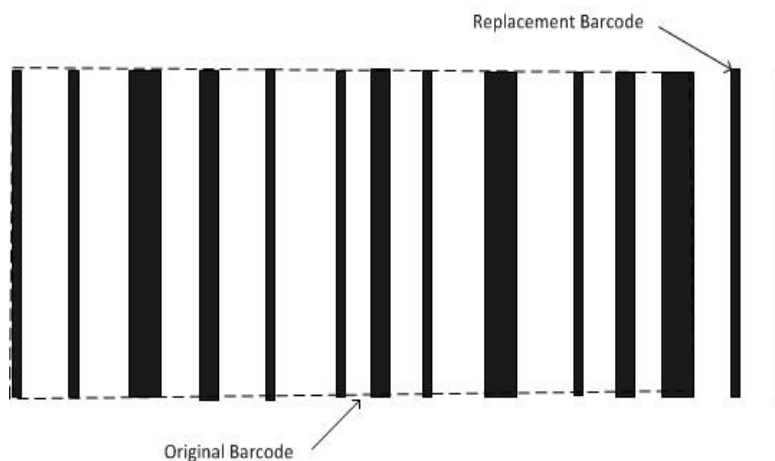

Any form elements (text, graphics, or dots) immediately to the right of the original barcode can force this first attempted placement to be modified. The replacement barcode will shift left to avoid obstacles on the right provided that there are also no obstacles on the left.

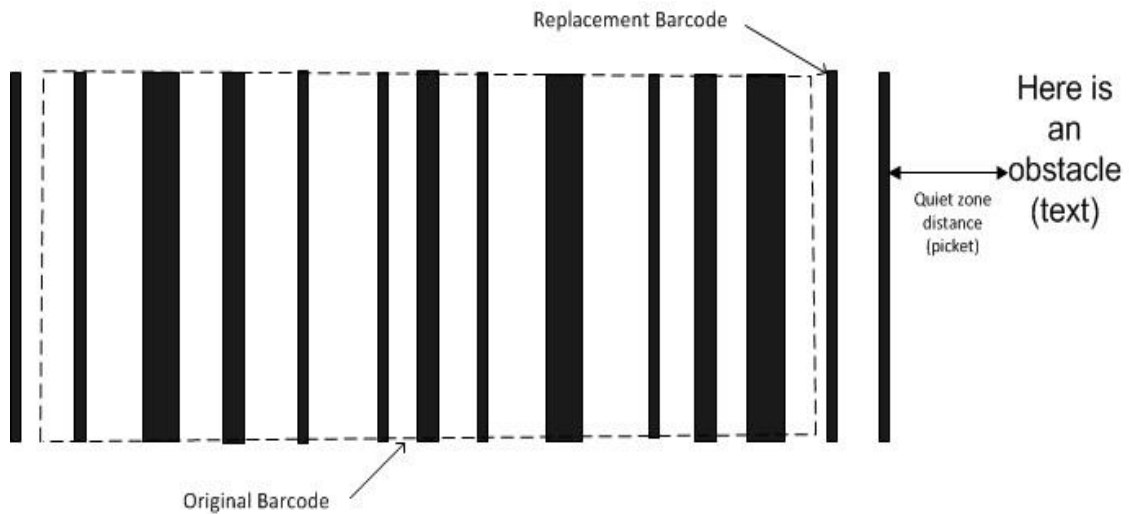

- **Center** (factory default). The first attempted position of the center bar of the replacement barcode will be the same position as the center bar of the original barcode.

If the replacement barcode is smaller than the original barcode, it will be replaced as follows:



If the replacement barcode is longer than the original barcode, it will still be centered, but it will extend beyond the end of the original barcode on both the left and the right.

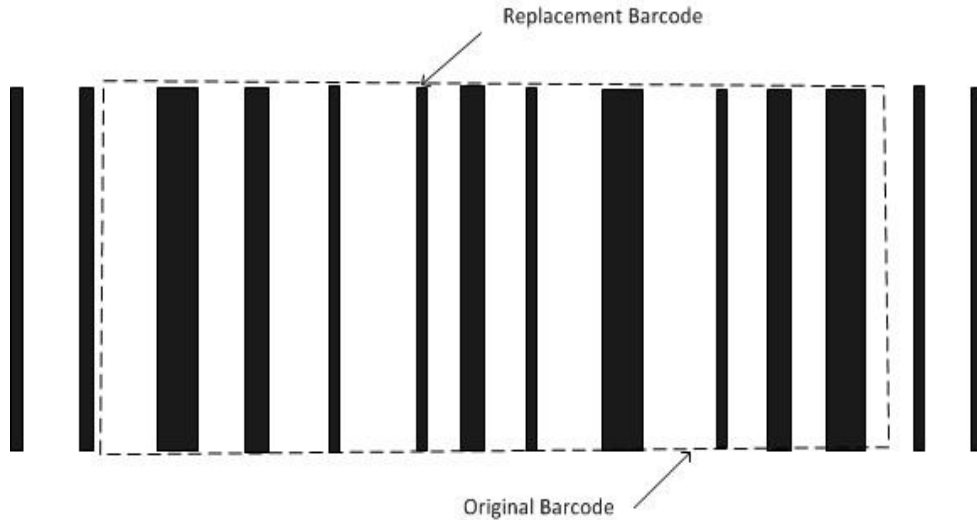

If form elements interfere with this placement on the right or the left, the barcode will automatically adjust away from these obstacles. Form obstacles may force a center-aligned barcode to look left or right aligned. For instance, in the below picture, a center-aligned barcode has text 0.2 inches away from the right edge of the original barcode. With a horizontal quiet zone of 0.2 inches, the resulting replacement barcode position is exactly the same regardless of whether center, right, or left alignment is chosen. Regardless of the first attempted position, the barcode will need to shift to the left until the horizontal quiet zone can be observed.

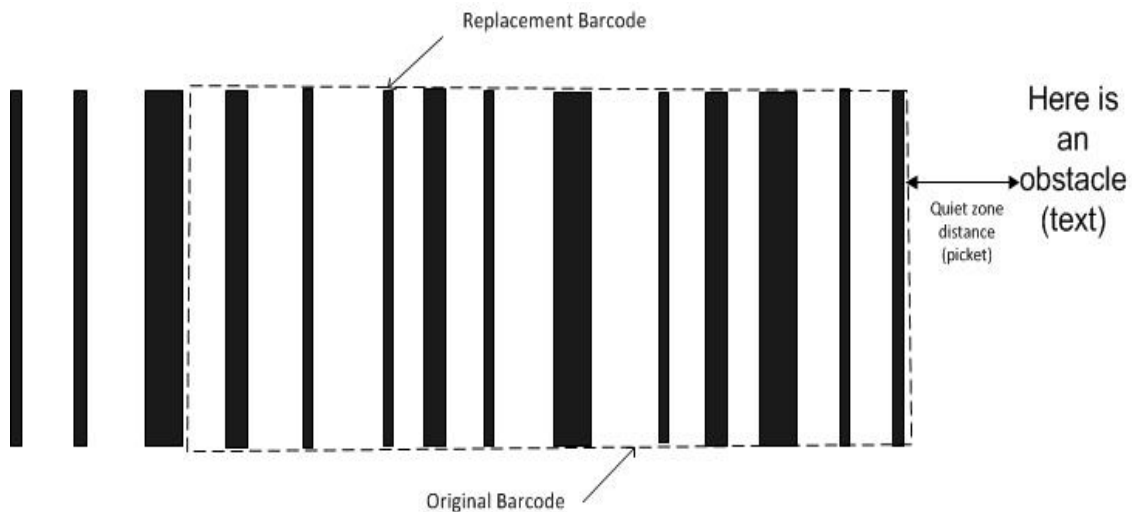

- **Right.** The first attempted position of the rightmost bar of the replacement barcode will be the same position as the rightmost bar of the original barcode.

For instance, if the replacement barcode is shorter than the original barcode it will be placed as follows:

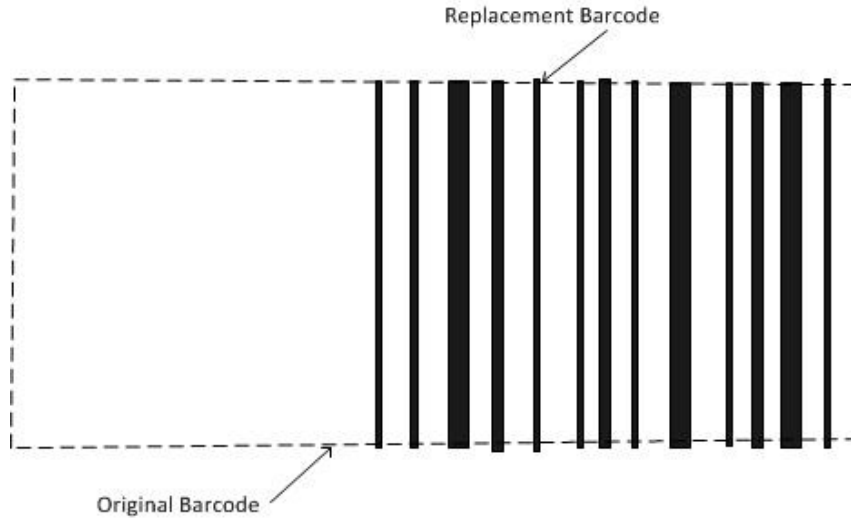

If the replacement barcode is larger than the original barcode, the replacement barcode will end at the right edge of the original barcode and extend past the left edge. Any form elements (text, graphics, or dots) immediately to the left of the original barcode, however, can force this first attempted placement to be modified. The replacement barcode will shift right to avoid obstacles on the left provided that there are also no obstacles on the right.

### Hor. Quiet Zone

This menu defines the quiet zones (empty areas) width before and after the start/stop codes regardless of picket fence or ladder orientation. When positioning the barcode, the quiet zone is taken into account when detecting collisions with other elements (dots) on the form. If one of the horizontal quiet zones is violated, the barcode will automatically shift to the left or right (for picket fence orientation) or up or down (for ladder orientation) to remove the quiet zone violation.

The width of the area can be defined between 0 and 0.99 inches in 0.01 inch increments. The default is 0.20 inches. This feature ensures that the replacement barcodes will be properly scanned.

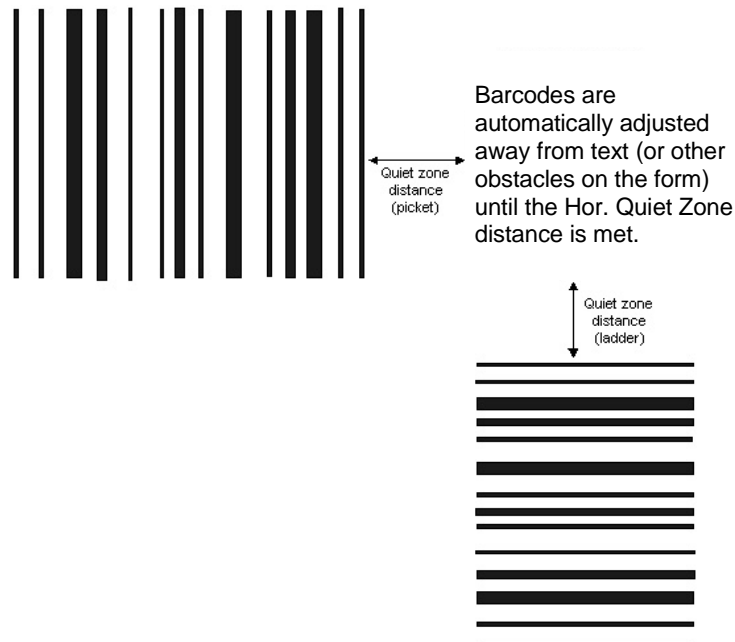

## Ver. Erase Zone

This menu defines the area above and below the bars that will be erased, regardless of picket fence or ladder orientation. It is used when the barcode has extraneous data beyond the bars that need to be deleted as it is being replaced.

The height of the area can be defined between 0 and 0.99 inches in 0.01 inch increments. The default is 0 inches (no empty space). This feature can be used to remove special attributes remainders of the original barcode such as a guard bar or line that borders the top and bottom of the bars. It can also be used to erase the original PDF if the user wants to force all PDFs to be replaced (see Update PDF on page 200). The PDF occupies more than 1/6 of an inch.

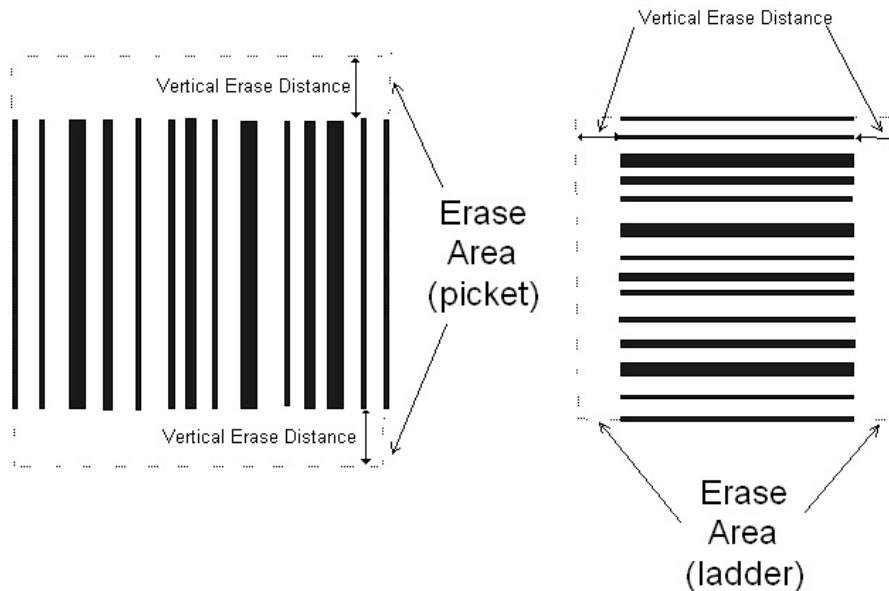

## Quiet Zone Fault

This menu defines whether a fault must be reported on the front panel LCD if the BCDOPT feature cannot print the replacement barcode without violating the quiet zone as defined in the "Hor. Quiet Zone" menu, where the width of the replacement barcode plus quiet zones is too large to fit the available white space on the page.

- **Enable** (factory default). If this fault occurs, reduce the quiet zone to see if the barcode fits.
- **Disable**. Quiet zone violations are not reported, but adjacent page elements could be drawn too close to replacement barcodes and possibly overlap.

## Update PDF

There are two distinct cases with barcode PDFs. In the first case, the PDF is partially embedded in the barcode such that erasing the bars also erases the PDF. In the second case, the PDF is printed entirely above or below the barcode and is not disturbed by the barcode replacement.

Whenever the PDF is embedded in the barcode such that erasing the bars also erases the PDF, the embedded PDF will be automatically detected and replaced. An area surrounding the barcode will be erased to remove the portions of the former PDF that extended beyond the bounds of the original barcode. The erase area is shown in the figure below. Since embedded PDFs are automatically replaced, the Update PDF menu option has no effect on this type of PDF.



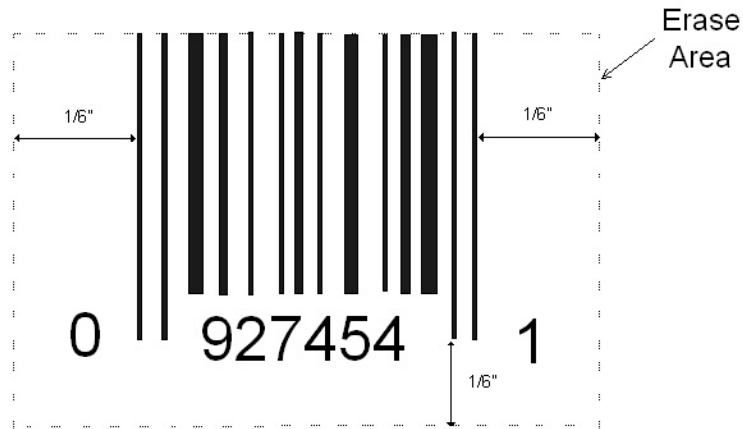

When the PDF is printed above or below the barcode, the behavior will depend on the Update PDF menu setting.

- **Embedded Only** (factory default). Embedded PDFs will not be replaced. This allows the user to keep the present PDF data and its font, etc.
- **Always**. PDFs will always reprint. For instance, since the original PDF will not be centered with respect to the replaced barcode, the user may want to always replace the PDF. When set to Always, an extra 1/8" is erased to remove the original PDF. If the original PDF is not fully erased, it is up to the user to increase the Ver. Erase Zone setting such that the original PDF will be completely erased prior to the replacement being printed.



### Barcodes on Page

This setting defines the number of barcodes that must be detected on the form. If the value is set to "Auto" (factory default), no particular number of barcodes are required to be detected. If the value is set to a number between 1 to 20, then the number of barcodes set is required to be detected on each form. If the printer detects fewer barcodes than the value set, the fault "x/y BARCODES / Not Found" is declared. x represents the number of barcodes not found, and y represents the Barcodes on Page value. Printing will not continue until the user clears this fault.

### Bcodes Optimized

This is a display menu that continuously counts the number of barcodes that have been optimized since power-up. This statistic only resets to zero when the printer is powered off. This menu can be used as a diagnostic to check the number of barcodes optimized over a period of time or over a batch file.

## PTX\_SETUP Option

Selects the Special Function Control Code for the PTX\_SETUP command and functions.

- **Setup Parse.** Disables or enables the PTX\_SETUP command.
- **Setup SFCC.** Allows you to choose the hex value of the ASCII character you wish to use as the SFCC for the PTX\_SETUP command. Valid hex values are 01-FF. The default value is hex 21, which corresponds to the “!” character.

## Hex Dump Mode

A hex code printout (or hex dump) translates all incoming data to hexadecimal equivalents. A hex dump lists each ASCII data character received from the host computer, together with its corresponding two-digit hexadecimal code. Hex dumps can be used to troubleshoot some types of printer data reception problems. The options include:

- **Disable** (factory default)
- **Enable**

Figure 44 on page 250. shows a hex dump sample.

## Power-Up State

- **Online** (factory default). The printer powers up in the online state.
- **Offline.** The printer powers up in the offline state.

**NOTE:** This option is not available in the PCL-II or LG emulation.

## Downloaded Fonts

Allows you to download a substitution table to replace any character in the current character set with a different character in the same font. The Downloaded Fonts menu applies to both LP+ Bitmaps and IGP Block downloaded characters. For example, performing a Delete from Flash option deletes both Bitmap and Block downloaded characters from flash memory.

- **Char Operations.** Allows you to delete a character from flash, load a character from flash, save a character to flash, and delete a character from RAM.
- **Ld Char at Pwrup.** Allows you to disable or enable loading a character at power up.
- **Set Operations.** Allows you to delete a character set from flash, load a character set from flash, save a character set to flash, and delete a character set from RAM.
- **Ld Set at PwrUp.** Allows you to disable or enable loading a character set at power up.

**NOTE:** This option is not available in the PCL-II or LG emulation.

- **DBCS Download.** Allows you to save and delete downloadable DBCS characters from flash.
- **Save to Flash.** Saves the downloaded characters from the DRAM to FLASH memory. These characters can be automatically reloaded when the printer powers on. The saved file name is “dbcswdn”. The characters need to be in the DRAM prior to saving into FLASH memory by using any download commands.
- **Delete DL. Font.** Deletes the “dbcswdn” file. The downloaded characters will no longer reside in FLASH memory on subsequent power-ups.

## PMD (Paper Motion Detection) Fault

- **Enable** (factory default). In the event of a paper jam, an audible alarm beeps, “CLEAR PAPER JAM” appears on the message display, and the printer stops printing.
- **Disable.** You should disable PMD only if special paper requires it.

**CAUTION** Once PMD is disabled, paper motion is not monitored. If a paper jam occurs, the printer ignores the condition and continues to print, possibly causing damage to the printer.

### Auto Locking

- **Disable** (factory default). The ENTER key must be locked manually.
- **Enable**. The printer automatically locks the ENTER key five minutes after the last front panel key press.

### Main File System

The Main File System refers to the flash resident on the P8000 controller.

- **Overwrite Files**. Allows you to prevent flash files from being overwritten by disabling the overwrite function.
- **View File List**. Displays the list of flash files in the main file system. Press the ENTER key to go into the submenu. Then press the UP or DOWN keys to view the different file names and size.
- **Delete Files**. Displays the list of flash files in the main file system. Press the LEFT or RIGHT keys to select the desired file to delete. Pressing the ENTER key deletes the file displayed on the control panel.
- **Flash Avail**. The amount of flash available for the user to save or download files into the main file system.
- **Flash Reclaimable**. The amount of flash marked deleted, but cannot be used until the Optimize&Reboot operation is performed.
- **Copy To SD**. If the SD card is inserted, the section will allow the user to copy selected files from the main file system to the SD card (root directory).
- **Optimize&Reboot**. Reclaims flash space from deleted flash files within the main file system. After pressing ENTER, wait for the printer to reboot.

**NOTE:** When the Optimize&Reboot option is executed, the message, "Optimizing Flash Files" does not display before printer rebooting takes place.

- **Print File List**. Prints a summary of the flash files stored in flash memory and several statistics on Main File System usage.

**IMPORTANT** Do not turn the printer off until it has completely rebooted and is either back online or offline.

### SD File System

The SD File System menu appears if an SD card is inserted in the printer before power-up. The SD File System applies only the SD card's root directory.

**IMPORTANT** If you remove or insert the SD card after the printer is powered on, an error will occur.

- **Overwrite Files**. Prevents SD files from being overwritten by disabling the overwrite function.
- **View SD Files**. Displays the list of files on the SD card (root directory). Press the ENTER key to go into the submenu, then press the UP or DOWN keys to view the different SD file names and size.
- **Delete SD Files**. Displays the list of SD files on the SD card (root directory). Press the LEFT or RIGHT keys to select the desired file to delete. Pressing the ENTER key deletes the file displayed on the control panel.
- **SD Flash Avail**. The amount of SD memory available for the user to save or download files into the SD card.

- **Copy From SD.** Copies selected files from the SD card (root directory) to the Main File System.
- **Print File List.** Prints a summary of the files stored on the SD card (root directory) and several statistics on the SD File System usage.
- **Update QCMC.** This menu can be used to update the configuration within the QCMC image stored on the SD card (see Appendix D, Quick Change Memory Card (QCMC)).
- **Erase QCMC.** This menu can be used to erase the QCMC image stored on the SD card (see Appendix D, Quick Change Memory Card (QCMC)).

### Set Sharing

This option allows character sets to be shared between the active LP+ protocol and the active IGP emulation.

Changing characters sets in LP+ causes the active IGP to change to the same character set if the selected set exists in IGP. If the active IGP has no access to the selected set, no changes are made. Selecting a new character set in the active IGP causes the LP+ to change to the same character set if the selected character set exists in the active LP+ protocol. Not all sets are shared between emulations in the Standard group of character sets. As a result, selecting a set in the Standard group of LP+ or IGP emulation may or may not cause the other emulation to have the same set.

**NOTE:** The Set Sharing front panel option has no effect on the LP+ build.

The option only applies to the builds with IGP.

This option is not available in the PCL-II or LG emulation.

### Shuttle Timeout

The amount of time the shuttle continues moving after no data is received. If your host is slow, setting the number to a higher value will prevent the printer from spending time shuttling up and down between data bursts.

### Slow Paper Slew

- **Disable** (factory default). The paper will slew and stack paper at maximum speed.
- **Enable.** Causes the paper to stack at a slower rate. This ensures that certain forms will stack neatly.

### Alarm

- **On** (factory default). An audible alarm sounds (3 beeps) when a fault occurs, such as a paper jam.
- **Cont. Beep.** A continuous audible alarm sounds when a fault occurs, which can be stopped by pressing CLEAR.
- **Off.** No audible alarm will sound.

### Power Saver Time

The time interval you specify for this parameter sets the amount of idle time before the printer goes into Power Saver mode. When Instant is chosen, the printer goes into Power Saver mode as soon as it is able to stop the shuttle properly. The time allotted to perform this function depends upon the shuttle timeout value which can be set in the menu.

**NOTE:** Power Saver Mode will not be shown on the control panel even though the function still exists. Sending a print job to the printer will turn off Power Saver mode.

### **Pwr Save Control**

Allows you to enable or disable the Power Save mode.

- **Enable** (factory default). Allows you to enable the Power Save mode.
- **Disable**. Allows you to disable the Power Save mode.

### **Cancel Key**

- **Disable**
- **Enable** (factory default). The CANCEL key may be used to clear all data in the print buffer without printing any of the data.

### **Rcv. Status Port**

This option defines the interface being used to receive the emulation status command.

- **Automatic** (factory default). When selected, the status command is sent to the printer with the print data through the active host interface.
- **Serial**. When selected, the status command is sent to the printer through the serial interface regardless of the active host interface.

### **Ret. Status Port**

This option selects the port for the Return Status Commands (i.e., ~STATUS for PGL) to send the status data back to the Host.

The options are Automatic (factory default), Serial, USB, E-NET Stat Port, IEEE 1284, Disable, and E-NET Data Port.

### **Set Lock Key**

Normally, to lock or unlock the printer menu, the UP and DOWN keys are pressed at the same time. The Set Lock Key parameter lets you choose different keys to lock or unlock the printer menu. You may choose almost any group of keys as the new lock and unlock keys. You cannot use the ENTER key or any key combinations which are already used for another function. There is no limit to how many keys you can select.

To set the new lock key, follow these steps:

1. Work your way through the configuration menu until the display reads "Set Lock Key" (follow the menu structure on page 194).
2. Press ENTER. The display reads, "Select a new lock key."
3. Press the combination of keys you want to be the new lock key. Make sure you press all keys selected at the same time.
4. If the selection is valid, the display will read, "Enter the new lock key again." If the selection is invalid, the display will read, "Invalid key selection." Return to step 2 and start over.
5. Press the same combination of keys a second time. If the new lock key combination is entered again correctly, the display will read, "Lock key has been changed." If it was entered incorrectly, the display will read "Verification failed." Start over at step 2.
6. After entering the new lock combination successfully, press the **ONLINE** key to put the printer back online.

**NOTE:** The new lock combination will remain even if the printer is powered off and back on.

### **Job Sel/Typeface**

**NOTE:** For H-Series printers only.

This option allows the user to change the printer's active configuration or typeface in Offline mode.

- **Job-Select On** (factory default). Allows the user to change the printer's active configuration.
- **Typeface On**. Allows the user to change the printer's typeface.

### Print Hist. Log

**NOTE:** For H-Series printers only.

Checks the status of user downloaded font files in the build.

### OCR Font Density

Determines the horizontal print density for OCR-A and OCR-B fonts. A higher density will print higher quality OCR fonts at the cost of a lower print speed. The vertical density is always 144 DPI.

- 120 DPI (Factory default)
- 180 DPI
- 240 DPI

**NOTE:** The maximum density for the IPDS emulation is 180 DPI.

### RBN Low Warn @

This option allows the user to select the Ribbon Life value at which point the printer will declare a ribbon low condition and display the "RIBBON UNDER XX% / Change RBN Soon" warning message. The default is Under 2%. See RBN Low Action below for details of how the printer behaves once a ribbon low condition is reached.

The values are Under 2% (factory default), Under 5%, Under 10%, Under 20%, and Under 30%.

### RBN Low Action

This menu determines how the printer behaves once a ribbon low condition is reached.

- **Warn & Continue** (factory default). Once a ribbon low condition is reached the printer beeps and displays the "RIBBON UNDER XX% / Change RBN Soon" warning message. Printing will continue without interruption. The warning message can be cleared by pressing the ONLINE/Clear button, however the message will persist again in two minutes. This action will continue until a ribbon out (ribbon life reaches 0%) condition occurs.
- **Warn & Pause**. This setting is similar to the Warn & Continue selection with one exception. When a ribbon low condition is reached the printer will still display the "RIBBON UNDER XX%/Change RBN Soon" warning message, however the printer will stop printing. This is meant to get the user's attention. To resume printing the user must press the ONLINE/ Clear key.

**NOTE:** Printing will only stop on the first occurrence of a ribbon low condition. Once the user clears the warning message, subsequent warnings will display the warning message but printing will continue.

### RBN End Action

This menu allows the user to override the normal ribbon low warning and ribbon out conditions.

- **Stop At RBN End** (factory default). When this factory default option is selected, the printer displays a warning message when a ribbon low condition is reached and display a ribbon out fault when ribbon life reaches 0%.
- **Ignore RBN End**. When this menu option is selected, it overrides the ribbon low and ribbon out conditions, i.e. no warning or fault messages is displayed and printing continues even after ribbon life reaches 0%. However, once the ribbon life reaches an excess wear condition as indicated by the fault

message "EXCESS RBN WEAR / Install New RBN", printing will stop and the user must install a new ribbon before printing can resume.

**NOTE:** The excess ribbon wear is set below the "Lighter -10" Ribbon End Point setting.

### **Print Energy (1000 lpm only)**

This menu allows the user to optimize energy or impact of the hammers when printing single or multipart forms.

- **Standard** (factory default). When this factory default option is selected, the printing energy is optimized for normal jobs.
- **PowerPrint**. When this option is enabled, printing is optimized for multi-part forms.

### **Disp. Intensity**

This menu controls the intensity of the LCD display. The range is 0-20 and the default setting is 2.

### **Program select**

This menu is available only with the ASCII bundle firmware and allows the selection of the active program. Choosing an active program will require the printer to reload its firmware causing all saved configurations to be lost. The process will take three to five minutes. Program Files are stored in the Flash Files System and can be deleted if more space is need in the Flash File System. Once the file has been deleted, the program will no longer appear in the Program Select menu. If all of the Program Files are deleted this menu will no longer be shown. The programs in the ASCII bundle firmware:

- IPDS/PGL/VGL/LP+
- TN 3270/5250
- ANSI
- PCL-II

# DIAGNOSTICS Menu

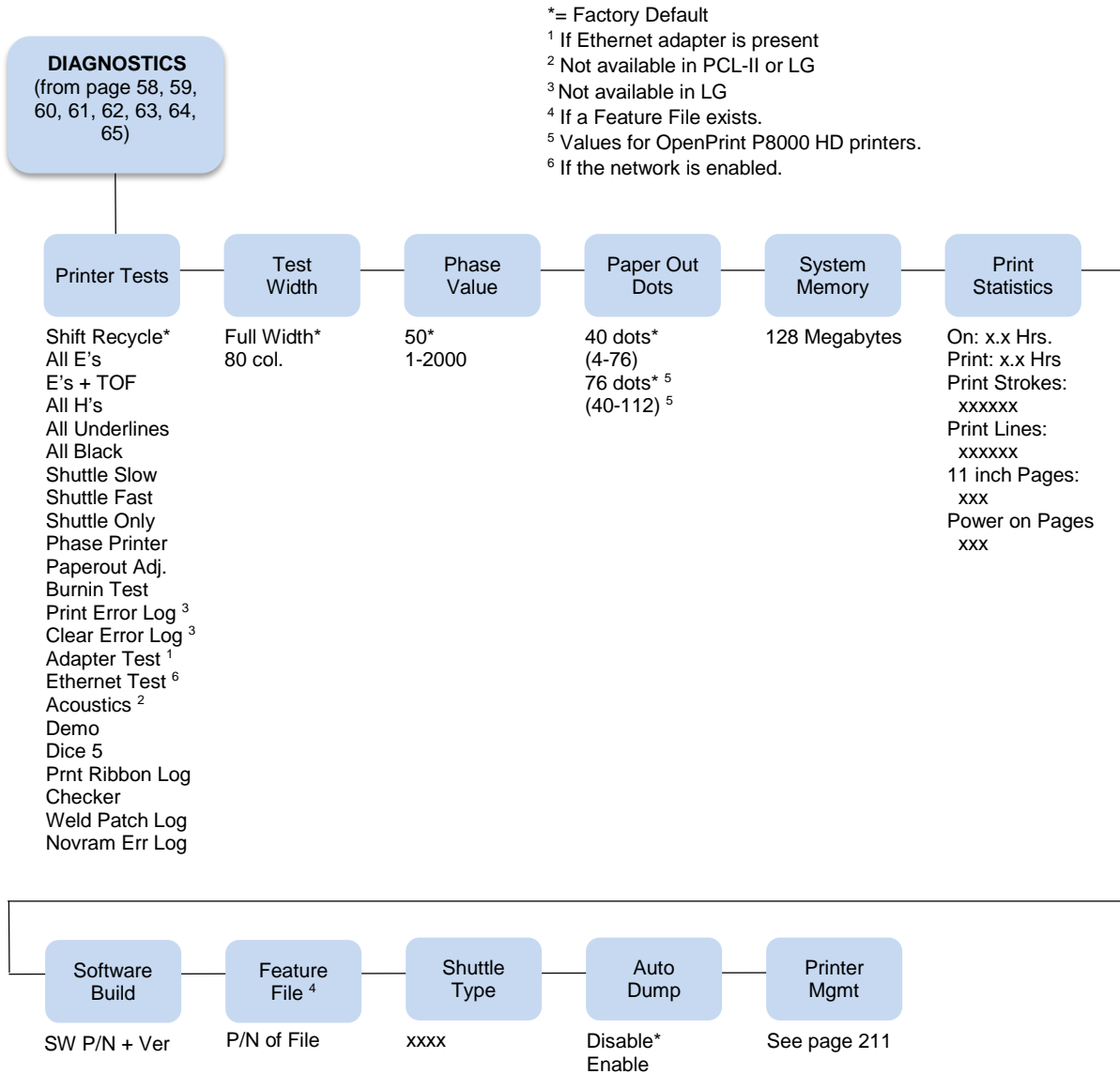



## Printer Tests

These tests are used to check the print quality and operation of the printer.

**NOTE:** Your authorized service representative will typically run the tests. They are described in more detail in the *Maintenance Manual*.

- **Shift Recycle.** A sliding alphanumeric pattern which identifies missing or malformed characters, improper vertical alignment, or vertical compression.
- **All E's.** A pattern of all uppercase E's which identifies missing characters, misplaced dots, smeared characters, improper phasing problems, or light/ dark character variations.
- **E's + TOF.** A pattern of all E's followed by a form feed to the next page top-of-form, which identifies paper motion or feeding problems.
- **All H's.** A pattern of all uppercase H's used to detect missing characters, misplaced dots, smeared characters, or improper phasing.
- **All Underlines.** An underline pattern useful for identifying hammer bank misalignment.
- **All Black.** A condition where all dot positions are printed, creating a solid black band.
- **Shuttle Slow.** Verifies proper operation by exercising shuttle and ribbon motion at low speed.
- **Shuttle Fast.** Verifies proper operation by exercising shuttle and ribbon motion at fast speed.
- **Shuttle Only.** Exercises only the shuttle at fast speed.
- **Phase Printer.** Checks for wavy print. The initial phase value is set in the factory. Run the test and check the quality. (The phase value prints on the left margin.) If the print looks too wavy, change the Phase Value parameter while the test is running. While the phase printer test runs, press the DOWN key. To change the value, press the PREV or NEXT key until the desired value displays and then press ENTER.
- **Paperout Adj..** Verifies the current Paper Out Dots setting, which determines where the last line of text will print when there is a paper out condition. Setting this parameter correctly prevents printing on the platen.
- **Burnin Test.** Reserved for factory use.
- **Print Error Log.** Prints the current log of errors. Most non-routine faults (ribbon stall, voltage faults) are stored in the error log.
- **Clear Error Log.** Clears entries in the error log.
- **Ethernet Test.** Prints the Ethernet statistics stored on the Ethernet (if present).
- **Acoustics.** A particular test pattern that is used to measure acoustics.
- **Demo.** Demonstration of various print attributes.
- **Dice 5.** Pattern used to measure print density.
- **Prnt Ribbon Log.** Prints log of cartridge installed in the printer.
- **Checker.** For factory use. This pattern helps identify marginal printhead elements, quality of edge sharpness, and uneven print quality.
- **Weld Patch Log.** Prints log times for ribbon starts, welds, and ribbon stops.
- **Novram Err Log.** Prints detailed information about the most recent Novram related failure that has occurred. It is useful when the front panel reports "BAD NVM" or "ILL NVM" error types. Contact the Customer Solutions Center and provide this information if such an error occurs.

## Test Width

Set this parameter to run the self-tests at full width or 80 columns.

## Phase Value

During the Phasing Test, this value changes until printing is phased. The range is between 1-2000.

## Paper Out Dots

**CAUTION** Only authorized service representatives should set this parameter.

This parameter is used to adjust the paper out distance from the perforation; you can specify where the last line on the page will print when there is a paper out condition. Setting this parameter correctly prevents printing on the platen.

## System Memory

Displays the amount of RAM installed.

## Print Statistics

You can view various printer statistics and refer to them for preventive maintenance purposes. Printer statistics accumulate continuously; they do not reset when you turn off the printer. All of the printer statistics are set to zero at the factory after burn-in testing.

- **On.** The cumulative time in hours the printer has been powered on. The range is 0 to 2,386,092 hours.
- **Print.** The cumulative time in hours the printer has actually been printing. The range is 0 to 2,386,092 hours.
- **Print Strokes.** The cumulative number of back-and-forth shuttle strokes the printer has printed during normal printer operation. The range is 0 to 2,147,483,647 shuttle strokes.
- **Print Lines.** The cumulative number of lines the printer has printed. The range is 0 to 2,147,483,647 print lines.
- **11 inch Pages.** The cumulative number of pages the printer has printed. The range in print pages is 0 to 2,147,483,647 total inches of paper movement divided by 11.
- **Poweron Pages.** The number of pages the printer has printed since power-up.

## Software Build

Displays the part number and version of the printer firmware.

## Feature File

Displays the part number of the file if one has been downloaded to the printer.

## Shuttle Type

Displays the type of shuttle installed, i.e. 2000s, 1500, 1000, 500, or high definition.

## Auto Dump

- **Disable** (factory default).
- **Enable.** When a printer get 'E03x' type of message on the operator panel, a dump file will be automatically created and store in flash as file "autodbg1.dbg" or "autodbg2.dbg" in the printer file system. This file can be uploaded to the host using the PrintNet Enterprise Suite application. Upon receipt of this file, it should be sent to Printronix Customer Support for review and evaluation.

## Printer Mgmt

Refer to the Printer Mgmt Menu on page 211.

# Printer Mgmt Menu

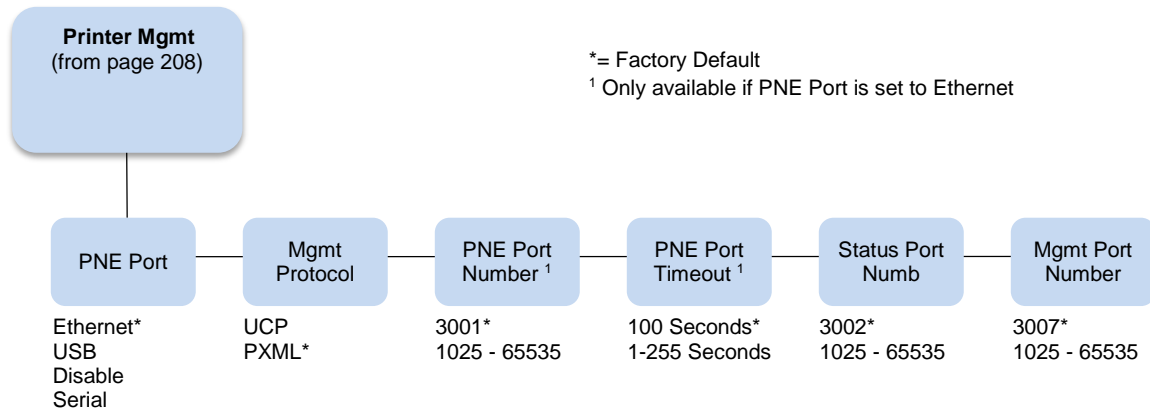

### PNE Port

This menu selects which port the printer expects PNE to connect to, via Ethernet or USB. The factory default is Ethernet. If the network is not enabled, the default is Disable.

### Mgmt Protocol

Since PXML and UCP management protocols share the same Ethernet Port, only one can be active at a time. This menu selects the active Management Protocol Interface, either PXML or UCP. The factory default is PXML.

### PNE Port Number

This menu selects the port number the printer expects the PNE to connect through. The factory default is 3001 and the range is from 1025 to 65535.

### PNE Port Timeout

If the PNE has not communicated to the printer within a timeout period, the PNE session closes. The factory default is 100 seconds. The range is from 1 to 255 seconds.

### Status Port Numb

This menu selects the port number the printer sends the emulation status. The factory default is 3001 and the range is from 1025 to 65535.

### Mgmt Port Number

This menu selects the port number the printer expects the PXML or UCP to connect through. The factory default is 3007 and the range is from 1025 to 65535.



# 5 Interfaces

## Overview

This chapter describes the host interfaces provided with the printer. The printer interface is the point where the data line from the host computer plugs into the printer. The interface processes all communications signals and data to and from the host computer. Plus, with the Auto Switching feature, you can configure the printer to accept several interfaces at the same time (see Auto Switching Submenu on page 78).

**IMPORTANT** To comply with Electromagnetic Compatibility (EMC) regulatory requirements all electrical signal interface cables connected to this printer must be of a minimal quality level, be of the correct length, and be properly installed.

The RS-232 port and parallel port interface cables must meet the following specifications:

- The cable design must be double shielded with a copper braid over an aluminum mylar foil and not just a conductive foil spiral wrapped around a drain wire.
- The shield must terminate coaxially (360 degrees) to a metal connector housing and not be terminated by just a simple wire lead.
- The cable length, including connectors, must be 3 meters or less.
- The cable connector anchor screws must be securely seated into the printer receptor hardware.

For reference purposes only, two specific Centronics parallel port cables that have been tested and found to comply with these requirements are Belkin® part number F2A046-10 and Primelogic® part number PLU 2823224. Other electrically equivalent cables are acceptable.

This chapter describes the interfaces provided with the printer.

### Standard Host Interfaces:

- High Speed Serial Port (RS-232)
- USB 2.0 Universal Serial Bus

### Optional Host Interfaces:

- Centronics Parallel
- IEEE 1284 parallel bidirectional
- Ethernet 10/100BaseT

In addition to descriptions for the multi-line interfaces, this chapter also provides instructions for configuration of terminating resistors for the parallel interfaces.

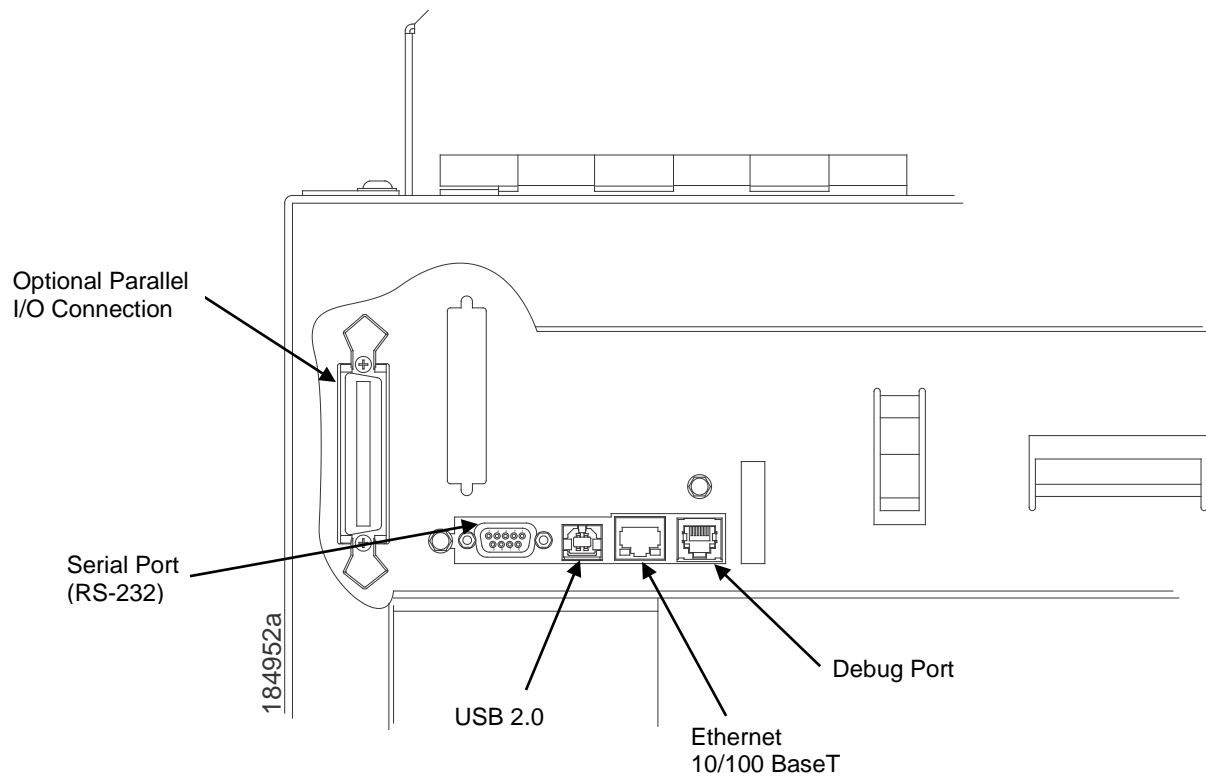

**Figure 21 Cabinet Model Interface Connectors**

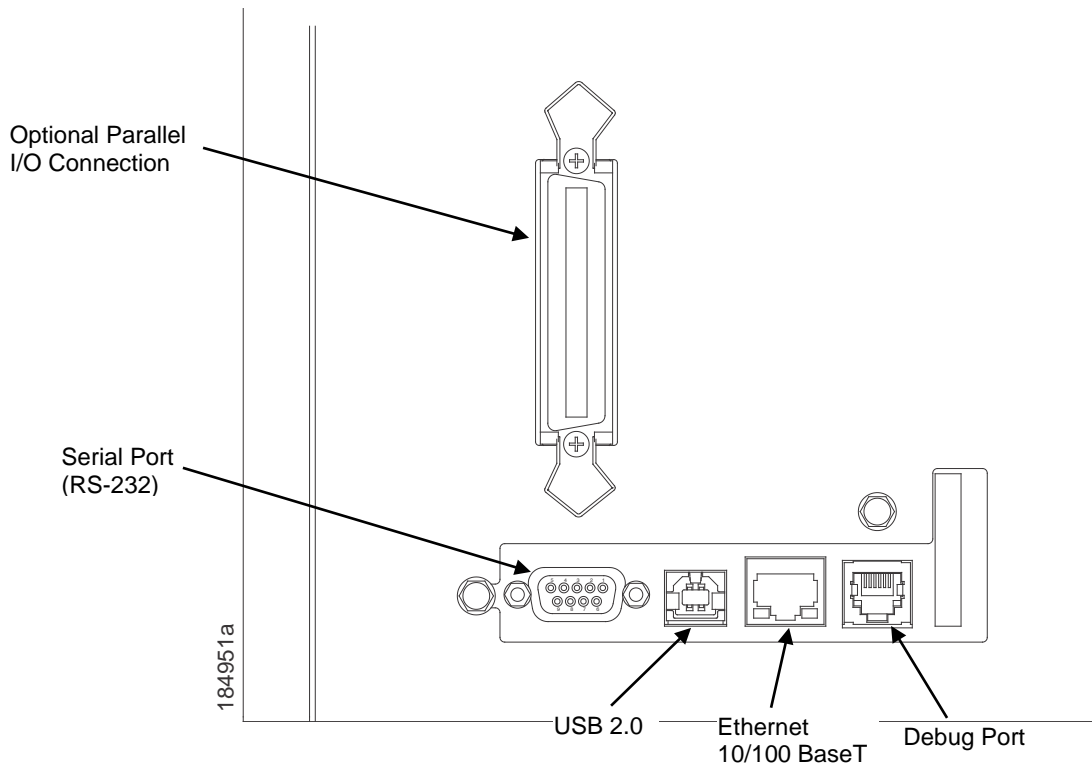

**Figure 22 Pedestal Model Interface Connectors**

# RS-232 Serial Interface

**NOTE:** The RS-232 serial interface circuit characteristics are compatible with the Electronic Industry Association Specifications EIA-232-E and EIA-422-B.

The RS-232 serial interface enables the printer to operate with bit serial devices that are compatible with an RS-232 controller. The input serial data transfer rate (in baud) is selectable from the printer's control panel. Baud rates of 600, 1200, 2400, 4800, 9600, 19200, 38400, 57600, and 115200 baud rates are available.

The length of the data cable from the host computer to the printer must not exceed 50 feet (15 meters) for RS-232.

**Table 15 Standard 500, 1000, 1500 and 2000 lpm Models  
RS-232 Serial Interface Connector Pin Assignments**

Input Signals		Output Signals		Miscellaneous	
Signal	Pin	Signal	Pin	Signal	Pin
Receive Data (RD)	3	Transmit Status & Control Data (TD)	2	Chassis Ground	1
Clear To Send (CTS)	5	Request To Send (RTS)	4	Signal Ground	7
Data Set Ready (DSR)	6	Data Terminal Ready (DTR)	20		
Data Carrier Detect (DCD)	8				

**Table 16 RS-232 Serial Interface Connector Pin Assignments**

Input Signals		Output Signals		Miscellaneous	
Signal	Pin	Signal	Pin	Signal	Pin
Receive Data (RD)	2	Transmit Status & Control Data (TD)	3	Chassis/Signal Ground	5
Clear To Send (CTS)	8	Request To Send (RTS)	7		
Data Set Ready (DSR)	6	Data Terminal Ready (DTR)	4		
Data Carrier Detect (DCD)	1				

**Receive Data (RD).** Serial data stream to the printer.

**Transmit Data (TD).** Serial data stream from the printer for transmitting status and control information to the host. Subject to protocol selection.

**Request To Send (RTS).** Control signal from the printer. Subject to configuration.

**Clear To Send (CTS).** Status signal to the printer indicating the host is ready to receive data/status signals from the printer.

**Data Set Ready (DSR).** Status signal to the printer indicating the host is in a ready condition.

**Data Carrier Detect (DCD).** Status signal to the printer. The ON condition is required for the printer to receive data.

**Data Terminal Ready (DTR).** Control signal from the printer. Subject to configuration.

# USB

## Menus

The Universal Serial Bus (USB) port is part of Auto Switching and is active when the Host Interface menu is set to Auto Switching. It can also be selected as the only Host Interface under the Host Interface menu by selecting USB.

A top level USB Port menu with two submenus is also available:

- **Buffer Size in K.** The input buffer size used by the USB port. The range is from 1 to 16. The default is 16.
- **Timeout.** The Hotport Timeout value used to determine when the port is inactive. The range is from 1 to 60 seconds. The default is 10 seconds.

## Centronics Parallel Interface

**Table 17 Centronics Interface Connector Pin Assignments**

Input Signals		Output Signals		Miscellaneous	
Signal	Pin	Signal	Pin	Signal	Pin
DATA LINE 1 Return	2 20	ACKNOWLEDGE Return	10 28	CHASSIS GROUND	17
DATA LINE 2 Return	3 21	ONLINE Return	13 28	GROUND	30
DATA LINE 3 Return	4 22	FAULT Return	32 29	Spares	14
DATA LINE 4 Return	5 23	PAPER EMPTY Return	12 28	No Connection	34,35, 36
DATA LINE 5 Return	6 24	BUSY Return	11 29	+5 Volts	18
DATA LINE 6 Return	7 25				
DATA LINE 7 Return	8 26				
DATA LINE 8 Return	9 27				
DATA STROBE Return	1 19				
PAPER INSTRUCTION Return	15 29				
PRIME Return	31 30				

The length of the data cable from the host computer to the printer must not exceed 15 feet (5 meters).



## Centronics Parallel Interface Signals

**Data Lines 1 through 8.** Provides eight standard or inverted levels from the host that specify character data, plot data, or a control code. Data Line 8 allows access to the extended ASCII character set. You may enable or disable this line via the Data Bit 8 parameter on the Centronics submenu (see page 81).

**Data Strobe.** Carries a low true, 100 ns minimum pulse from the host that clocks data into the printer.

**Acknowledge.** A low true pulse from the printer indicating the character or function code has been received and the printer is ready for the next data transfer.

**Online.** A high true level from the printer to indicate the printer is ready for data transfer and the ONLINE key on the control panel has been activated. When the printer is in online mode, it may accept data from the host.

**Paper Empty (PE).** A high true level from the printer to indicate the printer is in a paper empty or paper jam fault.

**Busy.** A high true level from the printer to indicate the printer cannot receive data.

**Prime.** A high true level from the host to indicate the printer should perform a warm start (printer is reset to the power-up configuration values).

**Paper Instruction (PI).** Carries a CVFU signal from the host with the same timing and polarity as the data line.

**Fault.** A low true level from the printer indicates a printer fault.

## IEEE 1284 Parallel Interface

The 1284 supports three operating modes, which are determined by negotiation between the printer and the host.

### Compatibility Mode

This mode provides compatibility with Centronics-like host I/O (see Table 18). Data is transferred from the host to the printer in 8-bit bytes over the data lines.

Compatibility Mode can be combined with Nibble and Byte Modes to provide bidirectional communication.

### Nibble Mode

Eight bits equals one byte. When a byte of data is sent to the printer, the eight bits are sent over eight data lines.

Some devices cannot send data over their eight data lines. To bypass this, the 1284 permits data to be sent as half a byte over four status lines. (Half a byte equals one nibble.) Two sequential four-bit nibbles are sent over the lines.

Data is transferred from printer to host in four-bit nibbles over the status lines, and the host controls the transmission.

### Byte Mode

The printer and host send data to each other along eight data lines (one bit per line).

If bidirectional communication is supported by the printer and the host, the host will take control of the data transfer.

### Signals

Table 18 lists each of the signals associated with the corresponding pins on the 1284 interface. Descriptions of the signals follow.

**Table 18 1284 Signals**

Pin	Source of Data	Type of Mode		
		Compatible	Nibble	Byte
1	Host	nStrobe	HostClk	Host/Clk
2	Host/Printer	Data 1 (LSB)		
3	Host/Printer	Data 2		
4	Host/Printer	Data 3		
5	Host/Printer	Data 4		
6	Host/Printer	Data 5		
7	Host/Printer	Data 6		
8	Host/Printer	Data 7		
9	Host/Printer	Data 8 (MSB)		
10	Printer	nAck	PtrClk	PtrClk
11	Printer	Busy	PtrBusy	PtrBusy
12	Printer	PError	AckDataReq	AckDataReq
13	Printer	Select	Xflag	Xflag
14	Host	nAutoFd	Host Busy	HostAck
15		Not Defined		
16		Logic Grid		
17		Chassis Grid		
18	Printer	Peripheral Logic High		
19		Signal Ground (nStrobe)		
20		Signal Ground (Data 1)		
21		Signal Ground (Data 2)		
22		Signal Ground (Data 3)		
23		Signal Ground (Data 4)		
24		Signal Ground (Data 5)		
25		Signal Ground (Data 6)		
26		Signal Ground (Data 7)		
27		Signal Ground (Data 8)		
28		Signal Ground (PError, Select, nAck)		
29		Signal Ground (Busy, nFault)		
30		Signal Ground (nAutoFd, nSelectIn, nInIt)		

**Table 18 1284 Signals**

Pin	Source of Data	Type of Mode		
		Compatible	Nibble	Byte
31	Host	nInit		
32	Printer	NFault	nDataAvail	aDataAvail
33		Not Defined		
34		Not Defined		
35		Not Defined		
36	Host	nSelectIn	1284 Active	1284 Active

**NOTE:** The length of the data cable from the host computer to the printer should not exceed 32 feet (10 meters).

**Host Clock / nWrite.** Driven by host. Data transferred from host to printer. When printer sends data, two types are available. If Nibble mode, signal is set high. If Byte mode, signal is set low.

**Data 1 through Data 8.** These pins are host-driven in Compatibility mode and bidirectional in Byte mode. They are not used in Nibble mode. Data 1 is the least significant bit; Data 8 is the most significant bit.

**Printer Clock / Peripheral Clock / Interrupt.** Driven by the printer. A signal from the printer indicating the character or function code has been received and the printer is ready for the next data transfer.

**Printer Busy / Peripheral Acknowledge / nWait.** Driven by the printer. Indicates the printer cannot receive data. (Data bits 4 and 8 in Nibble mode.)

**Acknowledge Data Request / nAcknowledge Reverse.** Driven by the printer. Indicates the printer is in a fault condition. (Data bits 3 and 7 in Nibble mode.)

**Xflag.** Driven by the printer. A high true level indicating the printer is ready for data transfer and the printer is on line. (Data bits 2 and 6 in Nibble mode.)

**Host Busy / Host Acknowledge / NDStrobe.** Driven by the host. Activates auto-line feed mode.

**Peripheral Logic High.** Driven by the printer. When the line is high, the printer indicates all of its signals are in a valid state. When the line is low, the printer indicates its power is off or its signals are in an invalid state.

**nReverse Request.** Driven by the host. Resets the interface and forces a return to Compatibility mode idle phase.

**nData Available / nPeripheral Request.** Driven by the printer. Indicates the printer has encountered an error. (Data bits 1 and 5 in Nibble mode.)

**1284 Active / nAStrobe.** Driven by the host. A peripheral device is selected.

**Host Logic High**—Driven by the host. When set to high, the host indicates all of its signals are in a valid state. When set to low, the host indicates its power is off or its signals are in an invalid state.

**nInit** —Resets init interface from the host.

## Ethernet

Refer to the *Integrated Network Interface User's Manual* for detailed information on the ethernet interface.



# 6 *Reprogramming the Security Key*

## Reprogramming the Security Key

The security key on the PSA3 controller board can be reprogrammed with a Software Program Exchange (SPX) module. The SPX is an intelligent module that plugs into the debug port on the back of the P8000. The SPX is used only once; it automatically overwrites itself after successfully reprogramming a security key. This allows the end user or a service technician to enable features such as new emulations without having to remove covers and install a new security key on the controller board.

The SPX is used at power-up only and is not left in the printer during normal operation. Because it is a single-use disposable item the user is not required to return it to the vendor or manufacturer.

### How to Program the Security Key

1. Power off the printer.
2. On cabinet models, open the rear door. On pedestal models, refer to Figure 23 to locate the debug port at the rear of the printer.
3. Insert the SPX into the debug port as shown.

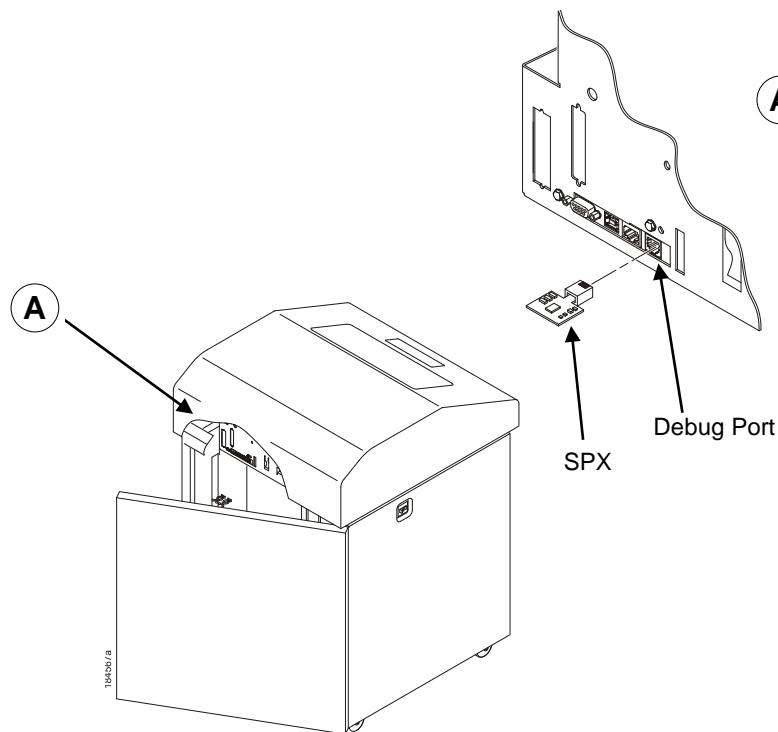

Figure 23 Inserting The SPX into the Debug Port

4. Power on the printer. The printer will begin its boot-up sequence.
5. When the printer detects a valid SPX, the control panel displays:  
"NEW SPX DETECTED PRESS ENTER"

**NOTE:** If an error message displays, find the message in the Message List in Chapter 8 and follow the troubleshooting instructions.

6. Press the **ENTER** key to activate the reprogramming sequence. The display will read:  
"PROGRAMMING. PLEASE WAIT."
7. When the security key is reprogrammed, the display will read:  
"UPGRADED - REMOVE SPX Downld code if needed"
8. Remove the SPX from the debug port at the rear of the printer.
9. Press the **ENTER** key. The printer will reboot itself and you may resume normal printing.
10. You may need to download a new program file to use the new feature.
11. You may need to set additional menu parameters for any new features that have been added or enabled.

# 7 *Downloading Firmware*

There is 256 MB of FLASH memory on the controller board. The printer firmware which includes printer control languages (the “emulations”), the engine control, and printer operating system software are loaded into FLASH memory at the factory, but there are occasions when you may have to load this software:

- Firmware upgrade to a newer level
- Changing to a different firmware (emulation) type
- Replacing a controller or reloading firmware if FLASH becomes corrupt.

Different firmware types may be included on a CD-ROM for printer upgrades. The target firmware type should be copied to a computer’s hard disk. From there, you can employ one of the various download methods presented in this section. Downloading firmware can be accomplished through any host IO installed on the printer, but may not be valid for all methods.

**NOTE:** The target firmware must be consistent with the options present in the controller Security Key. Otherwise, the firmware download will be prevented.

With exception to the manual two-key and manual three-key power- up sequences, downloading new firmware does not require the user to put the printer into any special mode. Rather, most downloading methods are employed when the printer is ONLINE and ready to receive data. This makes the download procedure easy.

FLASH is used to store the firmware, but it also contains a file system that holds System and User Flash Files. User Flash Files consist of downloaded fonts, logos, forms, setup files, feature files, CST files, and files that are specific to the user’s setup or application. These files are either preserved or deleted based on the download method used as shown in Table 19 on page 224.

**IMPORTANT** **Regardless of download method, any saved configurations will be erased. Before starting a download procedure, be sure that you have printed or saved configurations on your host computer so they can be restored after the download process is complete.**

**Table 19 Firmware Download Methods**

Firmware Download Method	File Type(s)	User FLASH Files
<b>Web Page (Ethernet only).</b> User needs the network option installed, a browser, and know the IP address.	FILENAME.prg	Preserved
<b>Windows Driver (any host IO).</b> When the Windows Driver is installed, downloading firmware can be done easily through the About/Help tab.	FILENAME.prg	Preserved
<b>Automatic download (any host IO).</b> Using the FILENAME.exe, firmware can be downloaded from a Windows Command Prompt without having to manually put the printer into download mode.	FILENAME.exe	Preserved
<b>Manual two-key download (any host IO).</b> This two-key (ADVANCE+CANCEL) power-up sequence puts the printer into download mode. Firmware can be loaded through any host IO port.	FILENAME.prg FILENAME.exe	Preserved
<b>Manual three-key download (USB or Parallel).</b> This three-key power-up sequence should be used in situations in which a new controller is installed, the program in FLASH is corrupt, or a different firmware type will be installed. Firmware must be loaded via USB or parallel (if installed).	FILENAME.prg FILENAME.exe	Deleted
<b>PrintNet Enterprise (Ethernet only).</b> User must install the PrintNet Enterprise application from the PrintNet CD. This is the most versatile and powerful method to upgrade printers but requires your computer can run Java™ programs.	For a detailed description, refer to the <i>PrintNet Ethernet User's Manual</i> .	

## Firmware File Types (.prg) and (.exe)

Using firmware with an .exe extension **FILENAME.exe** is convenient. However, firmware with the .exe extension may not be available in all situations. Download methods described in Table 19 which require the .prg extension, **FILENAME.prg**, is required (e.g., Windows Drivers and Web Page).

The **FILENAME.prg** file can be extracted from the **FILENAME.exe** file by executing the command in a Windows Command Prompt session:

```
FILENAME<Enter>
```

This will extract the **FILENAME.prg** file in the same directory where **FILENAME.exe** was executed. For example, executing **123456.exe** in the directory C:\download will generate a file C:\download\123456.prg.

**IMPORTANT** Be sure to copy the **FILENAME.exe** file to your computer's local drive before executing commands in the Windows Command Prompt.



# Web Page Download

**NOTE:** This download method requires firmware with the .prg extension

**FILENAME.prg.**

1. Make sure the printer is powered up, in ONLINE mode, and that the Ethernet cable is connected.
2. Get the IP address from the front panel (under Network Setup in the menus).
3. Enter the printer's IP address in your browser (e.g., http://10.224.5.21).
4. When prompted for a user name and password, enter "root" for user name and click OK.
5. Click "System" in the Configuration box.

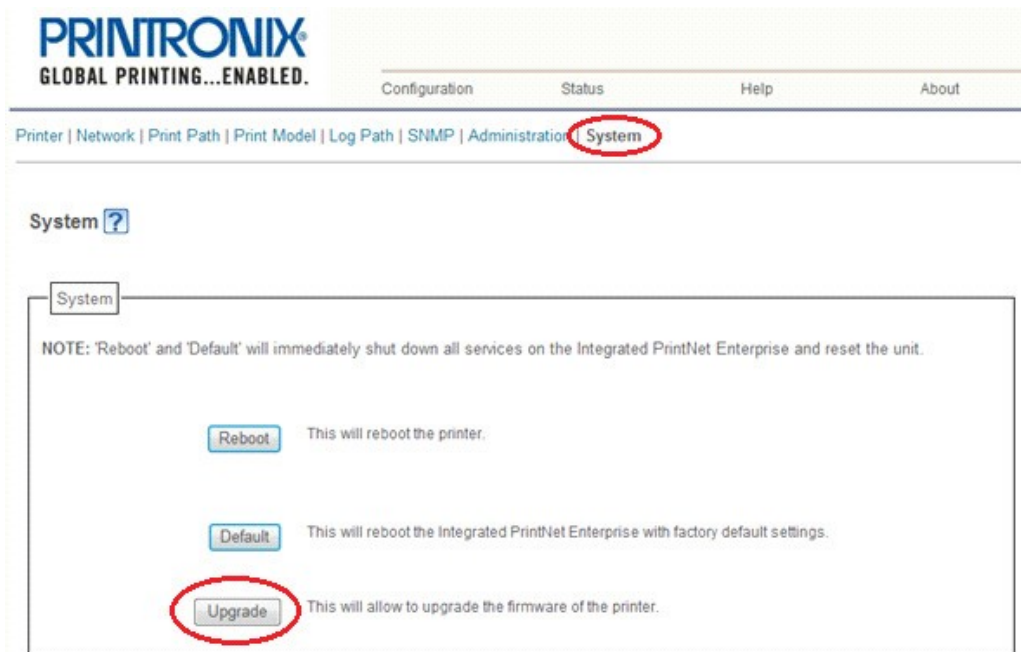

**Figure 24 System Configuration Upgrade**

6. Click the "Upgrade" button.
7. Browse to the directory or enter **FILENAME.prg** in the "File to upload" field and click "Upgrade". A Warning message opens.

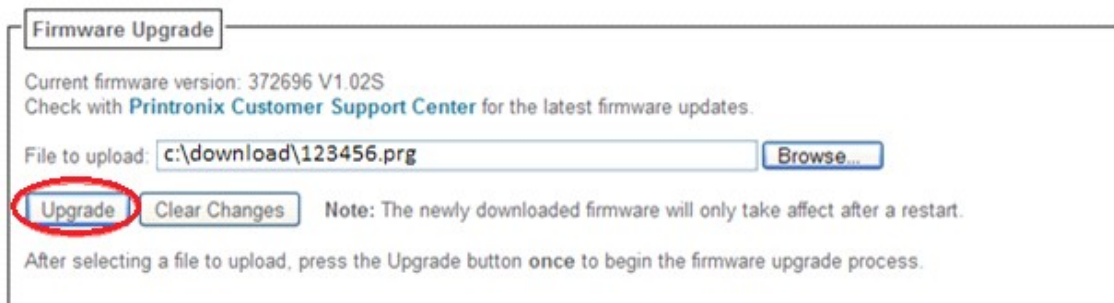

**Figure 25 Uploading Firmware File for Upgrade**

- Click "Ok" to continue. After a few minutes, you are prompted to reboot.
- Click "Yes".

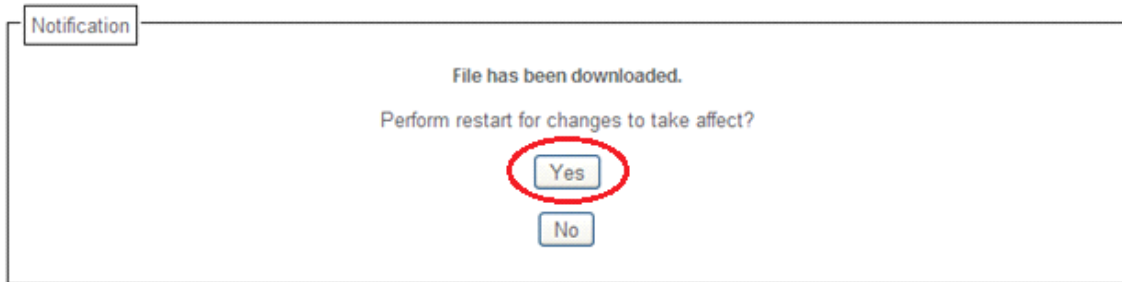

**Figure 26 Confirm Reboot**

- Wait until the printer is finished upgrading firmware.



**Figure 27 Waiting for Firmware Upgrade Completion**

- When the Web Page is redirected, the download process is complete.

# Windows Driver Download

**NOTE:** This download method requires firmware in the form **FILENAME.prg**.

1. Make sure the printer is powered up, in the ONLINE mode and that desired host IO cables are connected.
2. Install the Windows Driver 2000/XP/Server 2003/Server 2008/Vista/ Windows 7/Windows 8 on the Starter Kit CD before continuing. Alternatively, drivers can be found on the <http://www.primtronix.com/products/drivers.aspx> website.
3. Once the Windows Driver is installed on the PC, right-click the printer driver and select **Properties**.
4. Click the **About/Help** tab to access the software download option.
5. Click the **Firmware Update** button as in Figure 28.

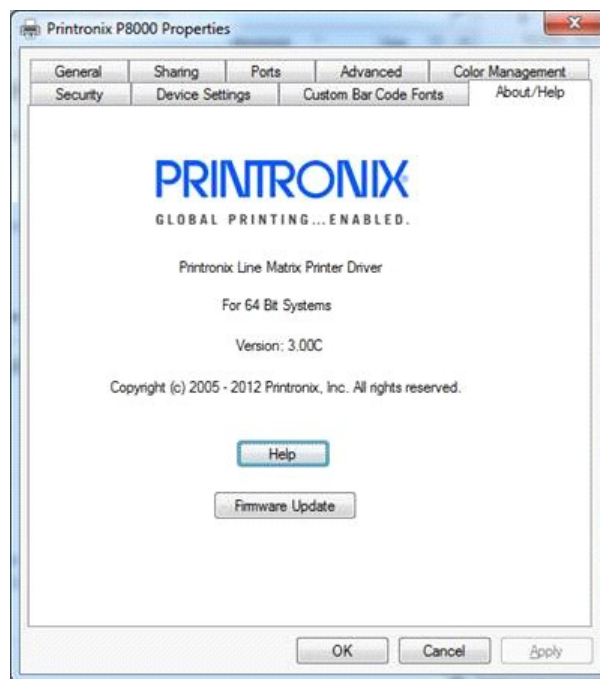

**Figure 28 Updating Firmware**

6. Enter the full path and location to the printer software. For example, **c:\download\FILENAME.prg** where c:\download is the directory where **FILENAME.prg** resides.
7. Click **OK** to send the software to the printer. To abort this operation, click **Cancel**.
8. When the new software has successfully loaded into flash memory and the printer has reset itself, the process is complete.

## Automatic Download (.exe)

**NOTE:** This download method requires firmware in the form **FILENAME.exe**. The firmware can be downloaded without requiring the user to manually put the printer into download mode.

1. Make sure the printer is powered up, in ONLINE mode, and that the applicable host IO cables are connected.
2. Navigate to the directory where the target firmware resides. If the target firmware is on the CD, insert the printer emulation software CD into your computer's CD drive.

**NOTE:** The target firmware must be in the format **FILENAME.exe** where the FILENAME is a six digit number with the **.exe** extension (e.g., **123456.exe**).

**IMPORTANT** For USB connections, the Windows Driver must be installed.

3. Install the Windows Driver 2000/XP/Server 2003/Server 2008/Vista/ Windows 7/Windows 8 on the Starter Kit CD before continuing. Alternatively, drivers can be found on the <http://www.printronix.com/products/drivers.aspx> website. During the installation, make sure to share the printer when prompted and record the "Share name".

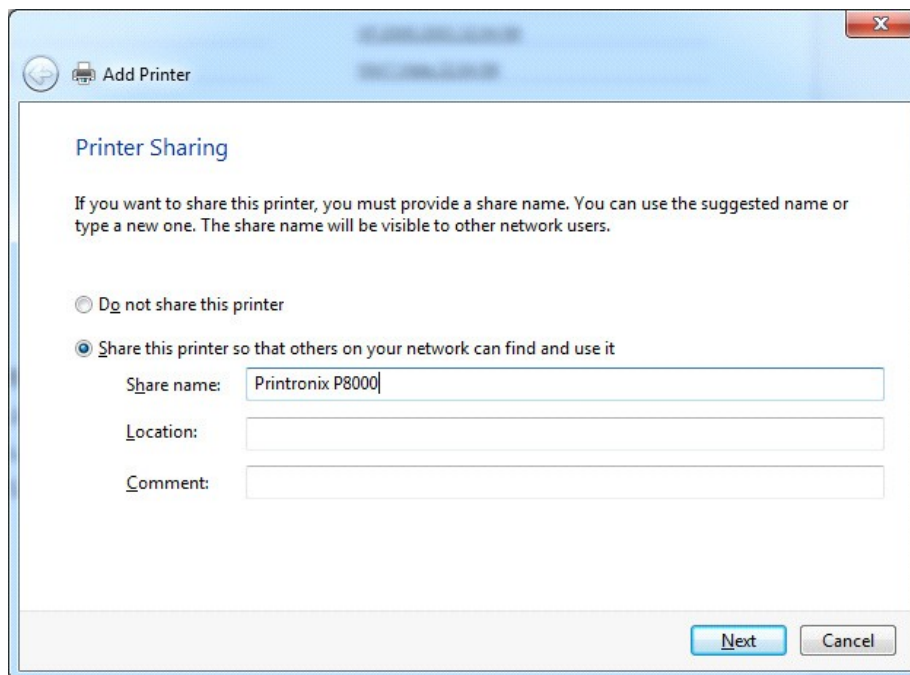
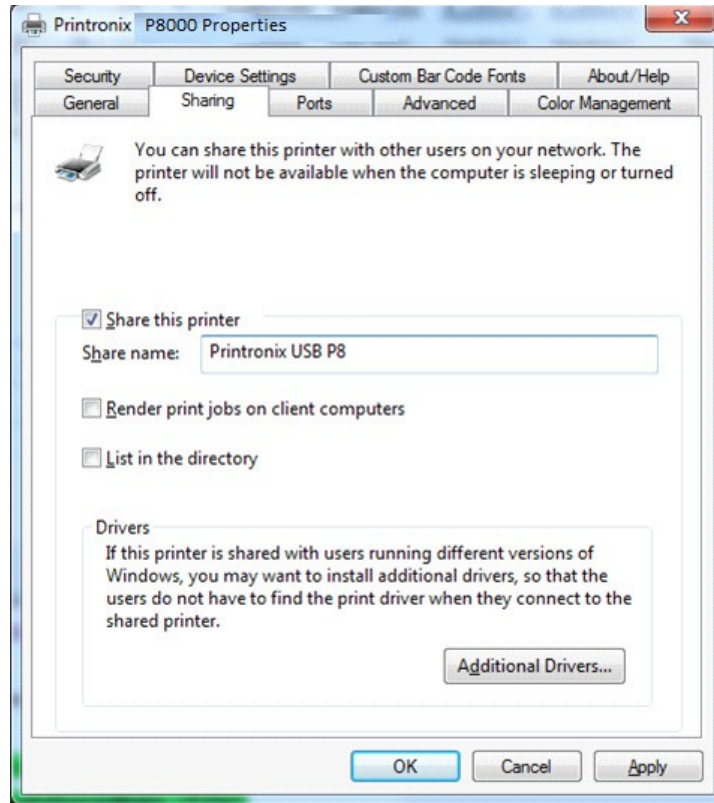

Figure 29 Selecting to Share the Printer

**IMPORTANT** For USB connections, the printer must have a "Share name" established.

4. The "Share name" will be needed when executing the **FILENAME.exe** command. This should be accomplished during installation, but can be verified at any time. Select the driver, right-click the mouse button and select "Printer Properties". Click the "Sharing" tab, make sure the "Share this printer" box is checkmarked, and enter the "Share name".



**Figure 30 Setting Printer Properties Sharing Options**

5. Start a Windows Command Prompt session.
6. Navigate to the directory with the target firmware (e.g., c:\download).
7. Execute **FILENAME.exe** as follows:

Connection Type	Enter Command
Parallel	<b>FILENAME -a -pb</b> <Enter>
Serial	<b>mode COM1:9600,N,8,1</b> <Enter> <b>mode LPT1=COM1</b> <Enter> <b>FILENAME -a -pb</b> <Enter>
USB	<b>FILENAME -a -pbSharedName</b> <Enter> where <i>SharedName</i> of the printer is the 'Share name' entered during installation.
Ethernet	<b>FILENAME -n xxx.xxx.xxx.xxx</b> <Enter> where <i>xxx.xxx.xxx.xxx</i> represents the IP address.

**IMPORTANT** DO NOT interrupt the downloading process once it has started. Interrupting a download will leave the flash memory on the controller PCBA incompletely loaded, and the printer may not boot up.

8. When the new software has successfully loaded into flash memory and the printer has reset itself, the process is complete.

## Manual Two-Key Download Sequence

**NOTE:** This download method can be completed with firmware in the form of *FILENAME.prg* or *FILENAME.exe*.

The following steps prepare the printer for download. When the printer is in the download mode, any host IO can be used to download the firmware.

1. Set the printer power switch to O (Off).
2. Connect the Ethernet cable to the printer interface.
3. Press and hold down the **ADVANCE** and **CANCEL** keys on the printer's control panel.
4. Set the printer power switch to I (On).
5. After five seconds, release the front panel keys.

The printer must power-up so this may take to 1-2 minutes. Wait until "PROGRAM DOWNLOAD" displays on the top line of the LCD before proceeding.

6. Start a Windows Command Prompt session.
7. Navigate to the directory with the target firmware (e.g., c:\download).
8. Send the firmware to the printer as described for various host IO options:
  - Sending Firmware via Ethernet (LPR) on page 231.
  - Sending Firmware via USB on page 231.
  - Sending Firmware via Parallel on page 237.
  - Sending Firmware via Serial on page 237.

## Manual Three-Key Download Sequence

**NOTE:** If the flash memory contains only boot code (e.g., if it is new), or if flash memory is corrupt, or you want to delete all Flash User Files, you must download software using the manual three-key download method. This can be completed with firmware in the form *FILENAME.exe* or *FILENAME.prg*. When the printer is in the download mode, only USB or parallel can be used to download the firmware.

1. Set the printer power switch to O (Off).
2. Connect the Ethernet cable to the printer interface.
3. **USB Download:**  
Press and hold down the **ADVANCE**, **CANCEL**, and **DOWN** control panel keys.

**Parallel Download:**

Press and hold down the **TOF**, **CONFIG**, and **UP** control panel keys.

**NOTE:** If the parallel option is not installed, the printer reverts to a USB download.

4. Set the printer power switch to I (On).
5. After five seconds, release the control panel keys.
6. The printer must power-up so this may take up to 1-2 minutes. Wait until "DOWNLOAD MODE USB" displays on the top line of the LCD before proceeding.

7. Start a Windows Command Prompt session.
8. Navigate to the directory with the target firmware (e.g., c:\download).
9. Send the firmware to the printer as described for various host IO options:
  - Sending Firmware via USB on page 231.
  - Sending Firmware via Parallel on page 237.

## Sending Firmware in Download Mode

This section describes how to send the firmware data to the printer using the desired host IO.

**NOTE:** The three-key download sequence only allows download through USB or Parallel.

Although the program file *FILENAME.prg* is used in the examples, any file with a Printronix header can be substituted in this process to download flash files.

### Sending Firmware via Ethernet (LPR)

**NOTE:** You will need the IP Address of the printer.

1. Enter the following to start the LPR program:

```
lpr -S xxx.xxx.xxx.xxx -P d1prn FILENAME.prg
where xxx.xxx.xxx.xxx is the IP Address of the printer.
```

**IMPORTANT** DO NOT interrupt the downloading process once it has started.

**Interrupting a download will leave the flash memory on the controller PCBA and NIC incompletely loaded, and the printer may not boot up.**

2. The process is complete when the new software has successfully loaded into flash memory and the printer has reset itself.

### Sending Firmware via USB

This section explains how to download firmware through USB by remapping LPT1 to the USB port. This can be completed with firmware in the form *FILENAME.exe* or *FILENAME.prg*.

If the PC or laptop you are using is connected to a network or the Microsoft Loopback Adapter is installed, then proceed as shown. If not, you must first complete the section Installing a Microsoft Loopback Adapter on page 232.

1. Remap the LPT1 port to USB by entering the following commands at the command prompt:

```
NET USE LPT1\\Comp_Name\Shared_Name/Persistent:YES <Enter>
```

where

*Comp\_Name* is the computer name found in System Properties\Computer Name tab

*Shared\_Name* is the printer's shared name found in the printer's Properties\ Sharing tab.

2. To check status of connection type, enter the following commands at the command prompt:

```
Net View \\Comp_Name <Enter>
```

where *Comp\_Name* is the computer name found in System Properties\ Computer Name tab.

Now the computer system is ready to send the firmware through USB.

3. Navigate to the directory with the target firmware (e.g., c:\download).
4. Copy the file to the printer by entering these commands at the command prompt:

```
copy /b FILENAME.prg lpt1: <Enter>
```

where *FILENAME.prg* is the target firmware or

**FILENAME -pb** <Enter>

where *FILENAME.exe* is the target firmware.

**IMPORTANT DO NOT interrupt the downloading process once it has started.**



**Interrupting a download will leave the flash memory on the controller PCBA incompletely loaded, and the printer may not boot up.**

5. The process is complete when the new software has successfully loaded into flash memory and the printer has reset itself.
6. To unmap LPT1 from USB, enter the following in the command prompt:  
**NET USE LPT1 /DELETE**<Enter>



## Installing a Microsoft Loopback Adapter

Use this section if USB is required for the download when the laptop or PC is not network connected. If your laptop or PC is already network connected, go to Sending Firmware via USB on page 231.

### 1. For Windows XP:

- a. Go to the “Start” menu 
- b. Select “Control Panel” 
- c. Open the “Add Hardware Wizard” 

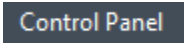
### For Windows 7:

- a. Go to the “Start” menu 
- b. Select “Control Panel” 
- c. Open the “Device Manager”  **Device Manager**
- d. Start the “Add legacy hardware” process from the “Action” menu as shown in Figure 31.

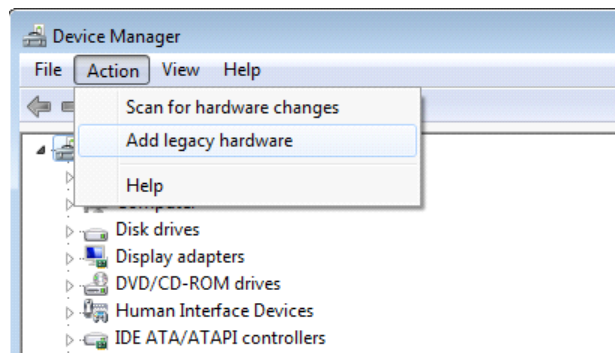

**Figure 31 Adding Legacy Hardware**

2. Click “Next” in the initial “Welcome to the Add Hardware Wizard” screen. The second screen will ask if you have already connected the hardware to your computer.
3. Select “Yes,...hardware” and then click “Next”.





**Figure 32 Hardware Connection Options**

4. Select "Add a new hardware device" (typically at the bottom of the installed hardware list) and then click "Next".

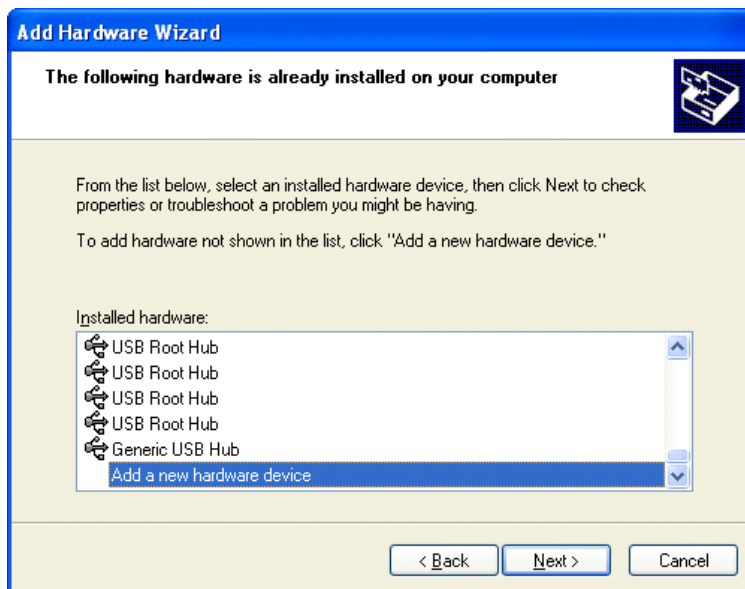

**Figure 33 Adding a New Hardware Device**

5. When asked how you would like to have the hardware installed, select the "Advanced" option that allows you to select the hardware from a list. Then click "Next".

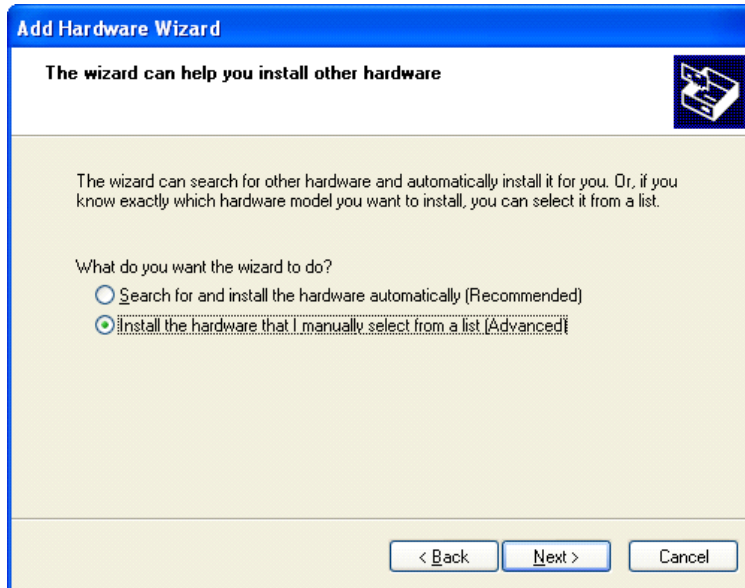

**Figure 34 Selecting the Advanced Installation Method**

6. Select "Network adaptor", then click "Next".

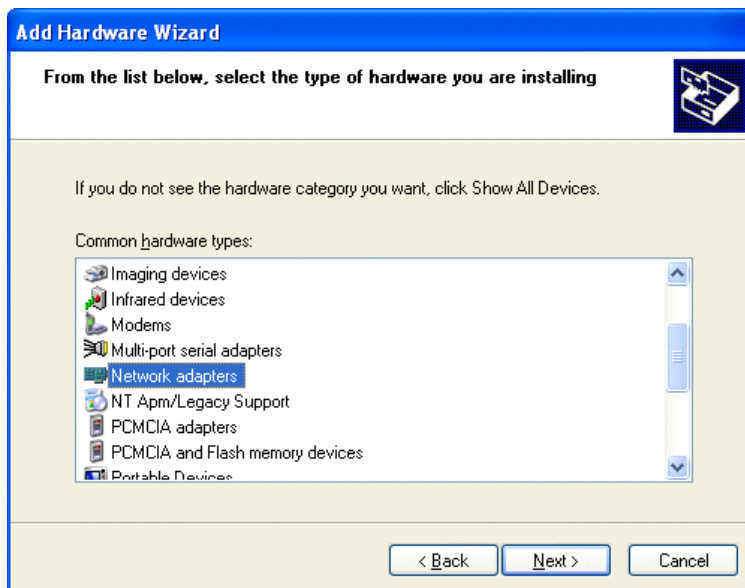

**Figure 35 Selecting Network Adapter Hardware**

7. Select "Microsoft Loopback Adapter", then click "Next".

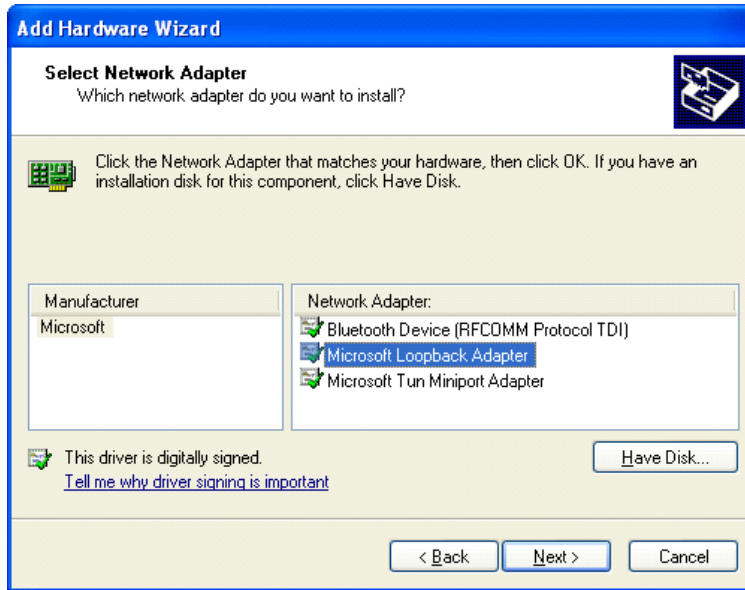

**Figure 36 Selecting Microsoft Loopback Adapter as the Network Adapter Type**

8. Click "Next" to start installation.

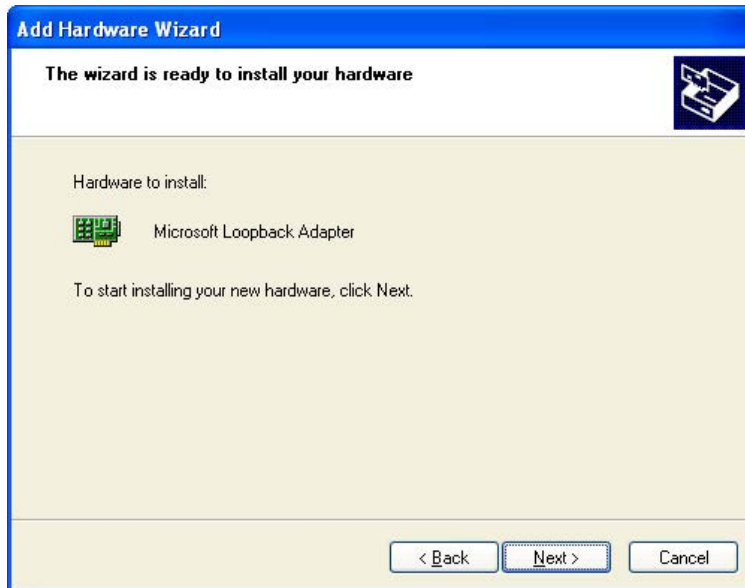

**Figure 37 Starting the Installation**

9. After installation is complete, click "Finish" to close the wizard.

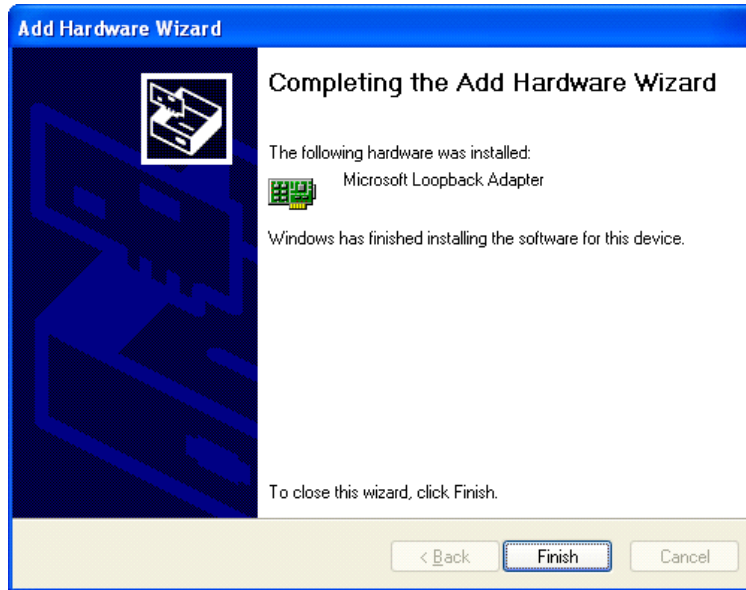

**Figure 38 Complete Hardware Installation**

10. To verify installation, go back to the Control Panel and select “System” for WinXP. Under the “Hardware” tab, select “Device Manager”. For Windows 7, select “Device Manager” directly from Control Panel.
11. Select the “Network Adaptors” and expand the selection if necessary. You should see “Microsoft Loopback Adaptor” listed. Leave all default settings.

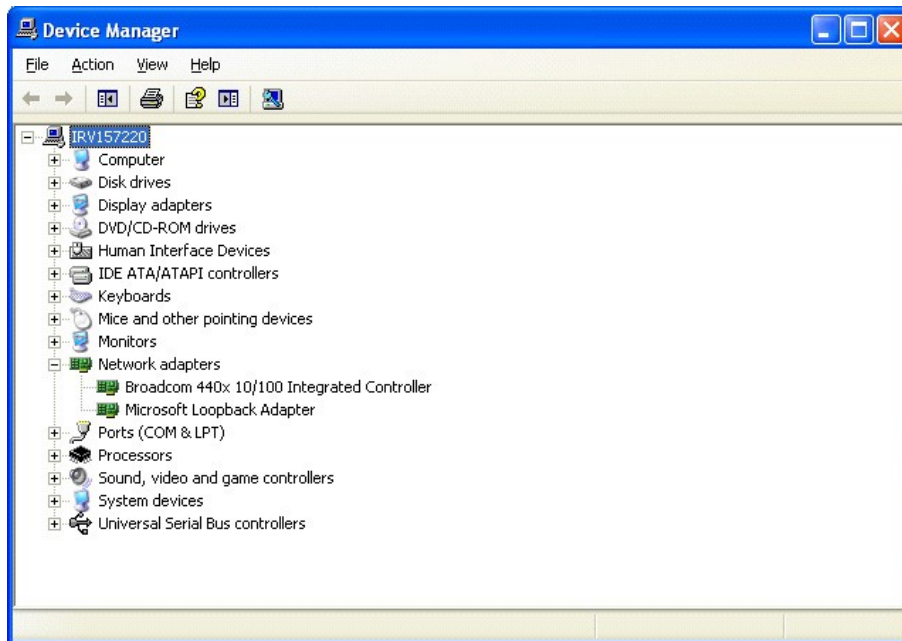

**Figure 39 Utilizing the Device Manager to Verify Installation**

12. Upon verification, go to Sending Firmware via USB on page 231.

## Sending Firmware via Parallel

This download method can be completed with firmware in the form

**FILENAME.exe** or **FILENAME.prg**.

**NOTE:** The parallel option must be installed.

1. Copy the firmware to the printer by issuing these commands at the Command prompt:

```
copy /b FILENAME.prg lpt1: <Enter>
```

where *FILENAME.prg* is the target firmware

or

```
FILENAME -pb <Enter>
```

where *FILENAME.exe* is the target firmware

**IMPORTANT** DO NOT interrupt the downloading process once it has started. Interrupting a download will leave the flash memory on the controller PCBA and NIC incompletely loaded, and the printer may not boot up.

2. The process is complete when the new software has successfully loaded into flash memory and the printer has reset itself.

## Sending Firmware via Serial

Downloading firmware using serial RS-232 is not recommended due to the size of the firmware and significant wait time required to complete the process. Downloading through serial requires firmware in the form **FILENAME.prg** only.

1. Copy the firmware to the printer by issuing these commands at the Command prompt:

```
mode COM1:9600,N,8,1,P <Enter>
```

```
copy /b FILENAME.prg com1 <Enter>
```

where *FILENAME.prg* is the target firmware.

**NOTE:** Some systems can only use the 9600 baud rate. The baud rate information entered in the above commands must match the Baud Rate setting saved in the Power-Up Config.

**IMPORTANT** DO NOT interrupt the downloading process once it has started. Interrupting a download will leave the flash memory on the controller PCBA and NIC incompletely loaded, and the printer may not boot up.

2. The process is complete when the new software has successfully loaded into flash memory and the printer has reset itself.

## Downloading Files to the Main File System

User Files can be downloaded into the Main File System (onboard PCB Flash) in a various ways as discussed in this section. This section does not cover specific methods used by the emulations but rather general ways of downloading files as shown in Table 20. Font download is discussed in a later section.

**Table 20 File Download Methods**

File Download Method	File Preparation
<b>Web Page (Ethernet only).</b> User needs to know the IP address and have a browser.	None required.
<b>PTX_SETUP (any host IO).</b> User can employ PTX_SETUP commands around the file data to store the file into the Main File System.	Binary (raw) data of the file is embedded within PTX_SETUP commands.
<b>Manual two-key download (any host IO).</b> This two-key ( <b>ADVANCE + CANCEL</b> ) power-up sequence puts the printer into download mode. Files can then be downloaded.	Run <code>cnvt2fls.exe</code> to add the proper header to the file
<b>PrintNet Enterprise (Ethernet only).</b> User must install the PrintNet Enterprise application from the PrintNet CD. This is the most versatile and powerful method to download files but requires your computer can run Java™ programs.	For a detailed description, refer to the <i>PrintNet Ethernet User's Manual</i> .

**NOTE:** Depending on the file download method, the file itself may need to be modified so that when it is downloaded to the printer, the printer stores the file with the correct Main File System name and file type.

## Filename Extensions Not Shown in Menus

Files with the one of the filename extensions below (upper or lower case) are considered system files and are not shown in the View File List or Delete Files menu.

**NOTE:** DO NOT download any user files with the extensions shown in Table 21.

**Table 21 Filename Extensions Not Shown In Menus**

Extensions		
*.bin	*.inf	*.ras
*.cpg	*.lfi	*.rfv
*.eng	*.map	*.sec
*.fon	*.pat	
*.gz	*.qsm	

# File Properties Not Shown in Menus

Files with one of the properties listed below (case sensitive) are considered system files and are not shown in the View File List within the Delete Files menu.

**NOTE:** DO NOT download any user files with the one of the properties shown in Table 22.

**Table 22 File Properties Not Shown In Menus**

Properties		
Prot	NetC	NGif
Rmap	Rfnt	Rmnu
Rprg	Eprg	VERS
ASIC	FPGA	UMCA
Rval	XHEX	RULE
CRft	Rver	Rsec
SORT		

## Web Page Download

1. Make sure the printer is powered up, in ONLINE mode, and the Ethernet cable is connected.
2. Obtain the IP address from the front panel (under Network Setup in the menus).
3. Enter the IP address of the printer in your browser (e.g., <http://10.224.5.21>).
4. Enter "root" for the user name when prompted, and click OK.
5. Click "Printer" in the Configuration box. The following webpage will display. Click "File Management" to download the file.



**Figure 40 Downloading Files using the File Management Webpage**

6. Click "Browse" to navigate the directory and find the download file, then click "Download File".

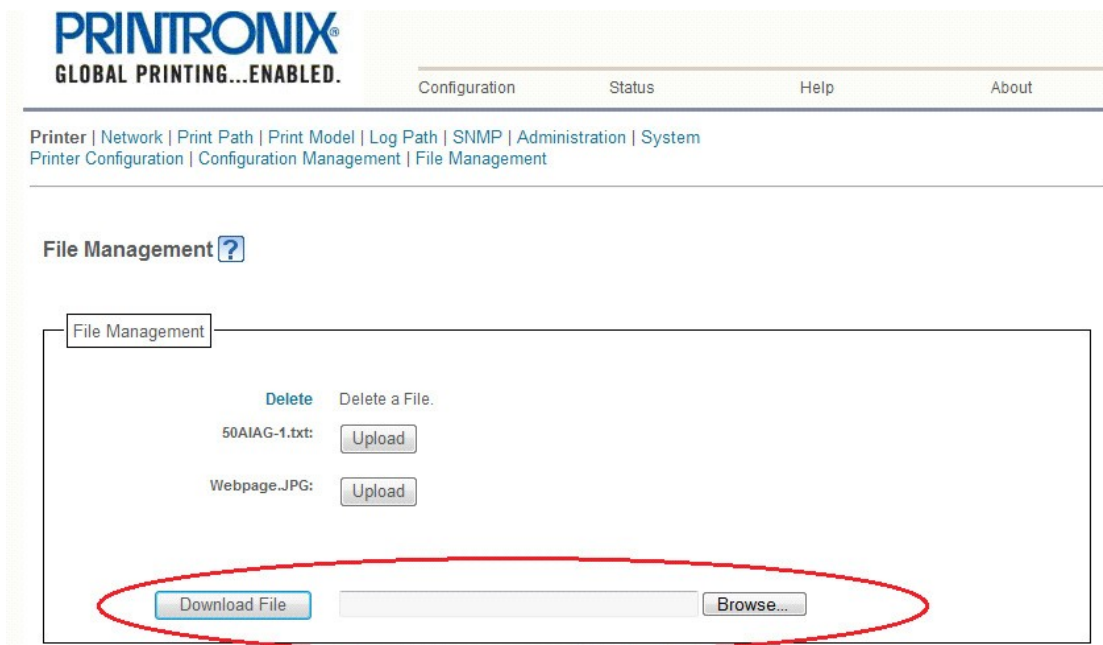

**Figure 41 Navigating to Download a File**



A notification displays indicating that the web page will refresh upon download completion.

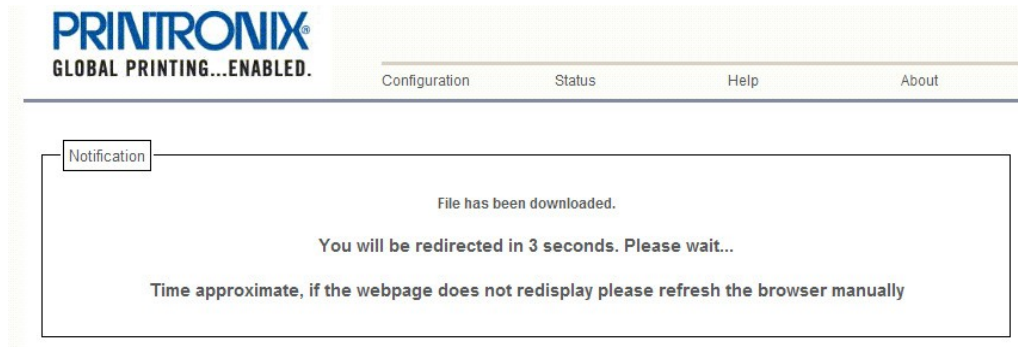

Figure 42 File Download Notification

## PTX\_SETUP Download

Use PTX\_SETUP to load files into the Main File System. Refer to the PTX\_SETUP Chapter in the *PGL Programmer's Reference Manual* for details.

Example loading a font named ARIAL.TTF:

```
!PTX_SETUP
FILE_IO-CAPTURE;"ARIAL.TTF" PTX_END
Arial TrueType font binary data.
```

**NOTE:** DO NOT add LF/FF to the end of the binary data.

```
!PTX_SETUP
FILE_IO-CAPTURE;" " PTX_END
```

## Manual Two-Key Download

1. Start a Windows Command Prompt session.
2. Navigate to the directory with the target file (e.g., c:\download).
3. Copy `cnvt2fls.exe` from your Starter Kit CD to the directory with the target file.
4. Convert the file to a downloadable format using the following command at the command prompt:

```
cnvt2fls file_name1 file_name2 file_name3 A FONT <Enter>
```

where

- `file_name1` is the name of the file to be converted into the downloadable format.
- `file_name2` is the name of the file of the output file that will be downloaded into the printer.
- `file_name3` is the name of the file within the Main File System.

**NOTE:** The FONT parameter should only be used with fonts; otherwise, omit this parameter

**Example:**

```
cnvt2fls arial.ttf arial.dwn ARIAL.TTF A FONT <Enter>
```

This example creates the file "arial.dwn" that will place "ARIAL.TTF" into the Main File System.

5. Place the printer in download mode as described in Manual Two-Key Download Sequence on page 230.
6. Send the file as described in Sending Firmware in Download Mode on page 231. Substitute *file\_name2* in place of the firmware **FILENAME.prg**.

The process is complete when the file successfully loads into flash memory and the printer resets.

7. Verify that the file is recognized and downloaded, go to the ADVANCED USER menu, in the Main File System submenu. One of the files displayed should include *file\_name3*.

## Downloading Files to the SD Card

SD files can be utilized by the printer and certain emulations such as PGL. Since the SD file format is an industry standard, downloading files and fonts to the SD card does not require special facilities within the printer. This allows the user to copy files from their PC or laptop to the SD card as well as copy printer files on the SD card to their PC or laptop.

**NOTE:** The printer will only locate files stored on the root directory of the SD card. The name of the file within the SD card root directory is the name shown in the SD File System submenu.

Alternatively, users can copy files from the Main File System to the SD card by using the “Copy to SD” selection within the Main File System menu. Users can also copy files from the SD card to the Main File System by using the “Copy from SD” selection within the SD File System menu.

PGL forms, fonts, and logos can all be read from and stored onto SD cards as described in the *PGL Programmer’s Reference Manual*.

**IMPORTANT** The SD card must be installed at the time of power-up and cannot be removed until the printer is powered off.

## Using TrueType Fonts

TrueType fonts allow you to customize the look of your forms and labels. You can download TrueType fonts purchased from various sources into your printer. The fonts are available for purchase on websites such as [www.fonts.com](http://www.fonts.com) and [www.myfonts.com](http://www.myfonts.com).

The following sections discuss how to:

- download TrueType fonts (page 242)
- select and print downloaded TrueType fonts (page 244)
- use TrueType fonts to print DBCS using UTF-8 (page 244)

**IMPORTANT** Line Matrix printers use bitmap fonts for smaller characters (less than or equal to 2x2). Since TrueType fonts are scalable fonts, use these fonts for sizes greater than 2x2.

### Downloading TrueType Fonts

You can download TrueType fonts to your printer by using any of the following methods:

- PTX\_SETUP (page 241)
- Web Page (page 239)
- PGL Emulation (see below)
- Adding a Font Header/Manual Two-Key Download (page 243).
- Labeling Applications (page 244).

Once a TrueType font is downloaded, it is stored in the Main File System or SD File System as a resident font. Regardless of printer power cycles, the downloaded font will stay in the printer until the user deletes it. The user can find a list of all printer resident fonts within the Main File System or SD File System submenus under ADVANCED USER. User downloaded fonts can be deleted from these same submenus. If within the Main File System, the user is recommended to perform an Optimize & Reboot function.

### PGL Emulation

A TrueType font can be loaded by creating a file that appends a PGL command to the font and then sending that file to the printer. Use the PGL FONTLOAD command:

```
~FONTLOAD;FontName;FontSize;Location
```

where

FontName TrueType font name, e.g. arial.ttf

FontSize TrueType font size, e.g. file size for arial.ttf

Location The download location. By default, "DISK" represents the Main File System (Flash), while "EMC" designates the SD card. The PGL menu "Storage Select" can be changed to force "DISK" to store fonts and other PGL elements to the SD card.

### Example:

```
~FONTLOAD;arial.ttf;60548;DISK
```

(Insert binary data of arial.ttf here.)

END

After the file is created, it can be copied to the appropriate printer I/O port while the printer is online, similar to other print files.

Example:

```
copy/b filename.ext lpt1 or LPT1
```

### Adding a Header/Manual Two-Key Download

To download a TrueType font to the printer through the manual two-key download mode, first add a header to the font, then place the printer in Download mode and download the font. A TrueType font can be converted to a downloadable format by appending a header to the font file using the `cnvt2fls.exe` utility and a batch file as described in this section.

#### Header for Main File System

1. Start a Command prompt window.
2. Copy (or unzip) `cnvt2fls.exe` and `addtthdr.bat` from your Starter Kit CD to your working directory (e.g., `c:\download`).
3. Copy the target TrueType font (.ttf) file to your working directory.
4. Start a Windows Command Prompt session.
5. Convert the TrueType font file .ttf (e.g., `arial.ttf`) to a downloadable format .dwn with the following command:

```
addtthdr filename <Enter>
```

where *filename* is the font name without an extension (e.g., `addtthdr arial`).

This creates the file `arial.dwn`.

6. Place the printer in download mode as described in Manual Two-Key Download Sequence on page 230.
7. Send the file as described in Sending Firmware in Download Mode on page 231. Substitute the file \*.dwn (e.g., arial.dwn) in place of the firmware **FILENAME.prg**.

The process is complete when the file has successfully loaded into flash memory and the printer resets itself.

8. Verify that the file is recognized and downloaded under the ADVANCED USER -> Main File System submenu. One of the files shown should include the original true type font name (e.g., arial.ttf).

### Header for SD Card

As discussed in Downloading Files to the SD Card on page 242, the process to copy TrueType fonts to the SD card can be employed from a PC or laptop by copying the target font file (\*.ttf) onto the SD card root directory. The SD card can then be placed in the printer and used accordingly.

### Labeling Applications

A TrueType font can be downloaded through several labeling applications, such as Codesoft, Loftware, and Bartender. Contact the appropriate company for more details.

### Select and Print Downloaded TrueType Fonts

After downloading the TrueType font using any of the following methods, you can access the downloaded TrueType font by using the command as described in the *PGL Programmer's Reference Manual*.

#### To Print ASCII Characters

You can print characters from your font using the currently selected character set. You can also select a new character set using the ISET command.

#### Example:

```
~CREATE;FORM
FONT;NAME ARIAL.TTF
ALPHA
10;10;3;3;$01234$
STOP
END
~EXECUTE;FORM;1
```

#### To Print All Characters

You can print all of the characters in your font using UTF-8. You must have a UTF-8 datastream to print.

#### Example:

```
~CREATE;FORM
ISET;'UTF8'
FONT;NAME ARIAL.TTF
ALPHA
10;10;3;3;$UTF-8 data$
STOP
END
~EXECUTE;FORM;1
```

# Demo Facility

To exercise the function of a Printronix printer in an environment where there is no host computer system available, you may need to execute a demo test file from the menu system. When executed, the demo test file will run through the emulations as if the host computer sent the file. Once completed, it will run the file again until terminated.

This section describes how to download, configure, execute, and terminate the demo. Demo files are treated as other User Flash Files and therefore are preserved across downloads by default.

## Downloading a Demo File

1. Start a Windows Command Prompt session.
2. Navigate to the directory with the target demo file (e.g., c:\download).
3. Copy (or unzip) demo2fls.exe from your Starter Kit CD to the directory with the target file.
4. Convert the file to a downloadable format with the following command at the command prompt:

```
demo2fls file_name <Enter>
```

where *file\_name* is the name of the file to be converted into the downloadable format.

The output file for download replaces the *file\_name* extension with “.fls”.

**Example:** demo2fls demo.txt <Enter>

This creates the file “demo.fls” that will place “demo.txt” into the Main File System when downloaded.

5. Place the printer in download mode as described in Manual Two-Key Download Sequence on page 230.
6. Send the file as described in Sending Firmware in Download Mode on page 231. Substitute the file \*.fls (e.g., demo.fls) in place of the firmware **FILENAME.prg**.

The process is complete when the file has successfully loaded into flash memory and the printer resets itself.

7. Verify that the file is recognized and downloaded under the DIAGNOSTICS -> Printer Tests submenu. One of the printer tests shown should include *file\_name*.

## Configuring the Printer to Run a Demo File

This facility does not attempt to identify which emulation a particular demo file is designed for. The user must configure the printer for the appropriate emulation before invoking the demo. The demo will inherit all menu configuration parameters when executed. The user is responsible to properly configure the forms size, typeface, orientation, etc. This facility will not restore any configuration settings when the demo file is finished printing.

## Starting a Demo File

The demo file is initiated by selecting its Flash File name and pressing ENTER within the DIAGNOSTICS -> Printer Tests submenu. This causes the printer to go online and print the demo file. Once the demo file starts, it will repeat automatically until the demo file sequence is stopped.

**IMPORTANT DO NOT run a demo file if the printer is in the middle of another test or host job. This will cause unexpected results. Similarly, do not send host jobs when running demo tests.**

## Pausing a Demo File

Pause the demo by placing the printer OFFLINE (press the ONLINE button). To resume printing, go back ONLINE.

**Stopping a Demo File**

Stop the demo by executing a soft reset on the printer (press the LEFT and RIGHT keys simultaneously). This will resume normal operation.

**Deleting a Demo File**

Delete demo files similar to any other file in the Main File System. Once deleted, the file will no longer appear as a selection in the Printer Tests submenu.

# 8 *Troubleshooting*

## **Cleaning Requirements**

Clean the printer every six months or after every 1000 hours of operation, whichever occurs first. If the printer is located in a dusty area or is used for heavy duty printing, clean it more often.

- WARNING**     **Disconnect the power source before cleaning the printer.**  
**Vor dem Säubern des Druckers ist die Netzverbindung zu unterbrechen.**  
**Débranchez l'alimentation avant de nettoyer l'imprimante.**  
**Desconecte la fuente de energía antes de limpiar la impresora.**  
**Staccare la fonte di energia prima della pulitura della stampante.**

### **Exterior Cleaning**

Clean the outside of the cabinet with a soft, lint-free cloth and mild detergent soap. (Dishwashing liquid works well.) Do not use abrasive powders or chemical solvents. Clean the windows with plain water or mild window cleaner. Always apply the cleaning solution to the cloth; never pour cleaning solution directly onto the printer.

### **Interior Cleaning**

Over time, particles of paper and ink accumulate inside the printer. This is normal. Paper dust and ink build-up must be periodically removed to avoid degraded print quality. Most paper dust accumulates around the ends of the platen and ribbon path.

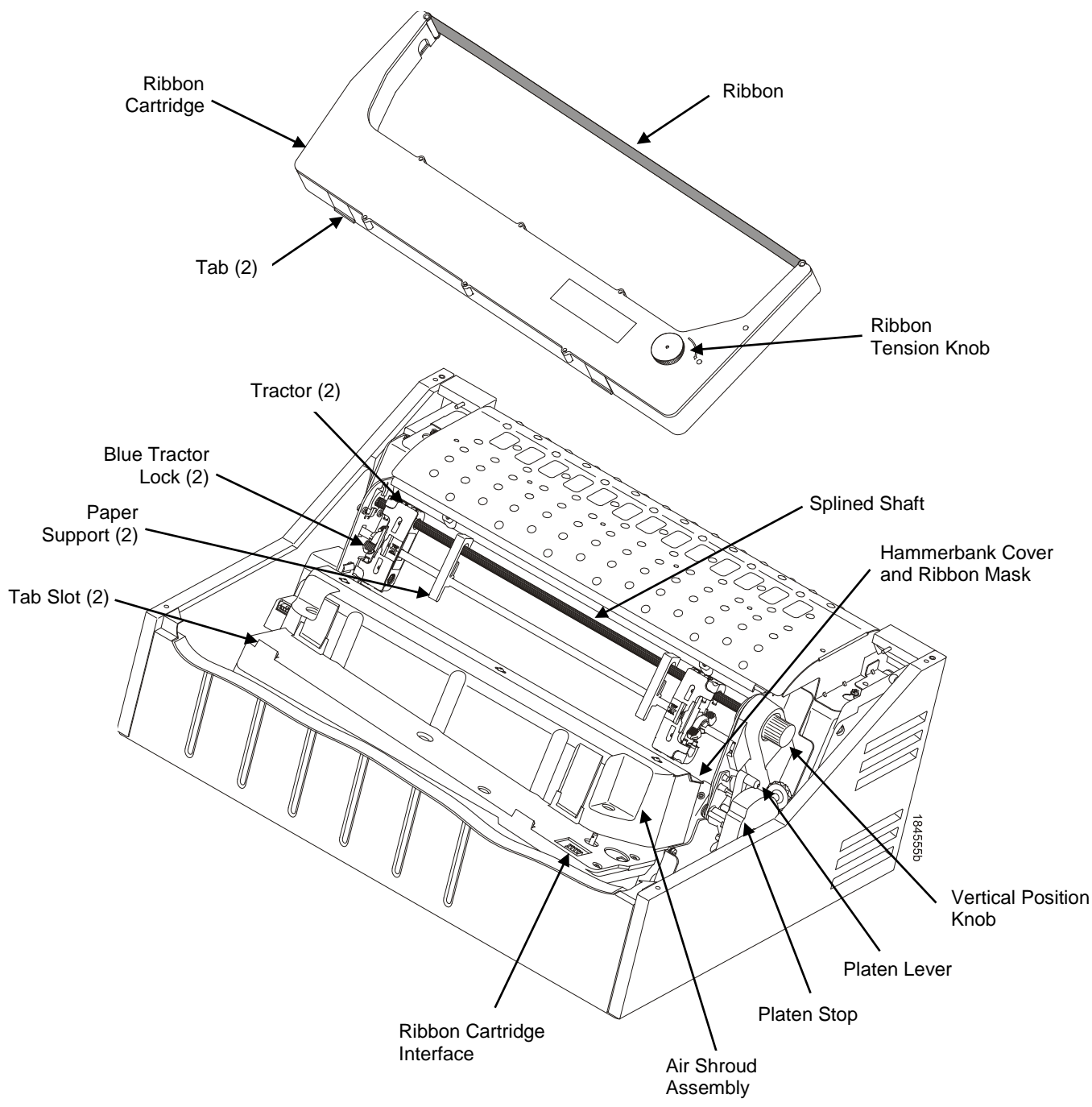

**Figure 43 Interior Printer Components**



To clean the interior of the printer perform the following steps.

1. Power off the printer and unplug the printer power cord.
2. Open the printer cover.
3. Fully raise the platen lever.
4. Unload the paper.
5. Remove the ribbon cartridge.
6. Lift the ribbon out of the ribbon path.
7. Brush the paper dust and ribbon lint off the tractors, shuttle cover assembly, and base casting with a soft-bristled, non-metallic brush (such as a toothbrush). Vacuum up the residue.

**CAUTION**      **Vacuum carefully around the hammer bank and surrounding area to avoid damage. To avoid corrosion damage, use only alcohol when cleaning the printer mechanical elements. Solutions used to clean mechanical elements must contain no water.**

8. Wipe the splined shaft with a soft cloth.
9. Check the ribbon mask and hammer bank cover for bits of torn paper or ribbon lint.
10. Remove dust and ink from the platen using a soft cloth lightly moistened with anhydrous alcohol. (The platen is the thick silver bar behind the hammer bank cover that rotates when the platen lever is rotated.)

**CAUTION**      **When cleaning the platen, be very careful not to get any alcohol in the hammer bank, because alcohol will cause severe damage to the hammer bank. Only a trained service technician should clean the shuttle assembly.**

11. Brush and vacuum the accumulated dust or residue inside the lower cabinet.
12. Wipe the lower cabinet interior with a clean, lint-free cloth dampened (not wet) with water and mild detergent or window cleaning solution. Dry the lower cabinet interior by wiping it down with a clean, lint-free cloth.
13. Install the ribbon and load paper.

## Diagnosing Problems

This section is designed to help you fix problems which may arise with normal printer operation.

### Bar Code Verification

The most important consideration when printing a bar code is to ensure that the bar code will be scanned properly. Incorporating a bar code quality procedure in the printing process is the best way to ensure that bar codes are being printed correctly. A properly implemented verification procedure will increase overall bar code quality, reduce waste from misprinted bar codes, and achieve high first-time read rates. A high first-time read rate is an increasingly important factor in newer, more efficient systems where manually entered data is not acceptable as a backup function. Verification also minimizes the costs of returned products due to poor reading or unaccountable bar codes.

## Printing a Hex Dump

A hex code printout (or hex dump) is a translation of all host interface data to its hexadecimal equivalent, listing all ASCII character data received from the host computer with their corresponding two-digit hexadecimal codes. Hex dumps are used to troubleshoot printer data reception problems.

Printable characters print as the assigned symbol; nonprintable characters are indicated by a period (.).

Figure 44 shows an example of a hex dump.

```

!##%&'()*+,-./ 20 21 22 23 24 25 26 27 28 29 2A 2B 2C 2D 2E 2F
0123456789:;<=>? 30 31 32 33 34 35 36 37 38 39 3A 3B 3C 3D 3E 3F
@ABCDEFGHIJKLMNO 40 41 42 43 44 45 46 47 48 49 4A 4B 4C 4D 4E 4F
PQRSTUVWXYZ[\]^_ 50 51 52 53 54 55 56 57 58 59 5A 5B 5C 5D 5E 5F
`abcdefgijklmno 60 61 62 63 64 65 66 67 68 69 6A 6B 6C 6D 6E 6F
pqrstuvwxyz{|}~ 70 71 72 73 74 75 76 77 78 79 7A 7B 7C 7D 7E 20
!##%&'()*+,-./O 21 22 23 24 25 26 27 28 29 2A 2B 2C 2D 2E 2F 30
123456789:;<=>@ 31 32 33 34 35 36 37 38 39 3A 3B 3C 3D 3E 3F 40
ABCDEFGHI..!##%& 41 42 43 44 45 46 47 48 0D 0A 21 22 23 24 25 26
'()*+,-./0123456 27 28 29 2A 2B 2C 2D 2E 2F 30 31 32 33 34 35 36
789:;<=>?@ABCDE 37 38 39 3A 3B 3C 3D 3E 3F 40 41 42 43 44 45 46
GHIJKLMNPOQRSTU 47 48 49 4A 4B 4C 4D 4E 4F 50 51 52 53 54 55 56
WXYZ[\]^_`abcd 57 58 59 5A 5B 5C 5D 5E 5F 60 61 62 63 64 65 66
ghijklmnopqrstu 67 68 69 6A 6B 6C 6D 6E 6F 70 71 72 73 74 75 76
vwxyz{|}~ !##%&' 77 78 79 7A 7B 7C 7D 7E 20 21 22 23 24 25 26 27
()*+,-./0123456 28 29 2A 2B 2C 2D 2E 2F 30 31 32 33 34 35 36 37
89:;<=>?@BCDEF 38 39 3A 3B 3C 3D 3E 3F 40 41 42 43 44 45 46 47
HI..!##%&'()*+,- 48 49 0D 0A 22 23 24 25 26 27 28 29 2A 2B 2C 2D
./0123456789:;<= 2E 2F 30 31 32 33 34 35 36 37 38 39 3A 3B 3C 3D
>?@ABCDEFGHIJKLM 3E 3F 40 41 42 43 44 45 46 47 48 49 4A 4B 4C 4D
NOPQRSTUVWXYZ[\ 4E 4F 50 51 52 53 54 55 56 57 58 59 5A 5B 5C 5D
^_`abcdefgijklm 5E 5F 60 61 62 63 64 65 66 67 68 69 6A 6B 6C 6D
nopqrstuvwxyz{|} 6E 6F 70 71 72 73 74 75 76 77 78 79 7A 7B 7C 7D
~ !##%&'()*+,- 7E 20 21 22 23 24 25 26 27 28 29 2A 2B 2C 2D 2E
./0123456789:;<=> 2F 30 31 32 33 34 35 36 37 38 39 3A 3B 3C 3D 3E
?@ABCDEFGHIJ..## 3F 40 41 42 43 44 45 46 47 48 49 4A 0D 0A 23 24
%&'()*+,-./01234 25 26 27 28 29 2A 2B 2C 2D 2E 2F 30 31 32 33 34
56789:;<=>?@ABCD 35 36 37 38 39 3A 3B 3C 3D 3E 3F 40 41 42 43 44
EFGHIJKLMNQRST 45 46 47 48 49 4A 4B 4C 4D 4E 4F 50 51 52 53 54
UVWXYZ[\]^_`abcd 55 56 57 58 59 5A 5B 5C 5D 5E 5F 60 61 62 63 64
efghijklmnopqrst 65 66 67 68 69 6A 6B 6C 6D 6E 6F 70 71 72 73 74
uvwxyz{|}~ !##% 75 76 77 78 79 7A 7B 7C 7D 7E 20 21 22 23 24 25
&'()*+,-./012345 26 27 28 29 2A 2B 2C 2D 2E 2F 30 31 32 33 34 35
6789:;<=>?@ABCDE 36 37 38 39 3A 3B 3C 3D 3E 3F 40 41 42 43 44 45
FGHIJK..%&'()*+ 46 47 48 49 4A 4B 0D 0A 24 25 26 27 28 29 2A 2B
,-./0123456789: 2C 2D 2E 2F 30 31 32 33 34 35 36 37 38 39 3A 3B
<=>?@ABCDEFGHIJK 3C 3D 3E 3F 40 41 42 43 44 45 46 47 48 49 4A 4B
LMNOPQRSTUVWXYZ 4C 4D 4E 4F 50 51 52 53 54 55 56 57 58 59 5A 5B
\]^_`abcdefgijk 5C 5D 5E 5F 60 61 62 63 64 65 66 67 68 69 6A 6B
lmnopqrstuvwxyz{ 6C 6D 6E 6F 70 71 72 73 74 75 76 77 78 79 7A 7B
}|}~ !##%&'()*+ 7C 7D 7E 20 21 22 23 24 25 26 27 28 29 2A 2B 2C

```

Figure 44 Hex Dump Sample

The CD contains a utility called hexcode.exe. This utility can be run from a DOS window to convert an input file into a hexadecimal equivalent. The output from this utility can then be used to compare what is received when printing a hex dump.

Usage: **hexcode** <input file> <output file>

Sample output:

```
412068657820636F6465207072696E746F757420286F7220686578206475
6D70292069732061207472616E736C6174696F6E206F6620616C6C20686F
737420696E74657266616365206461746120746F20697473206865786164
6563696D616C206571756976616C656E742C206C697374696E6720616C6C
204153434949206368617261637465722064617461207265636569766564
2066726F6D2074686520686F737420636F6D707574657220776974682074
6865697220636F72726573706F6E64696E672074776F2D64696769742068
657861646563696D616C20636F6465732E204865782064756D7073206172
65207573656420746F2074726F75626C6573686F6F74207072696E746572
206461746120726563657074696F6E2070726F626C656D732E200D0A0D0A
5072696E7461626C652063686172616374657273207072696E7420617320
7468652061737369676E65642073796D626F6C3B206E6F6E7072696E7461
626C6520636861726163746572732061726520696E646963617465642062
79206120706572696F6420282E292E0D0A0D0A3C2050696374757265206F
66204865782044756D70203E0D0A0D0A54686520434420636F6E7461696E
732061207574696C6974792063616C6C656420686578636F64652E657865
2E2054686973207574696C6974792063616E2062652072756E2066726F6D
206120444F532077696E646F7720746F20636F6E7665727420616E20696E
7075742066696C6520696E746F20612068657861646563696D616C206571
756976616C656E742E20546865206F75747075742066726F6D2074686973
207574696C6974792063616E207468656E206265207573656420746F2063
6F6D706172652077686174206973207265636569766564207768656E2070
72696E74696E672061206865782064756D702E0D0A0D0A55736167653A20
686578636F6465203C696E7075742066696C653E203C6F75747075742066
696C653E2E0D0A
```

## Most Frequent Problems and Solutions

Problem	Corrective Action
Poor print quality <ul style="list-style-type: none"> <li>• dark print</li> <li>• light print</li> <li>• light print on half of the page</li> <li>• missing dots or characters</li> <li>• smeared print</li> <li>• wavy vertical lines</li> </ul>	<ul style="list-style-type: none"> <li>• Adjust the forms thickness lever setting. Print quality can be affected if it is too loose or too tight.</li> <li>• Adjust the paper tension horizontally by moving the right tractor. Print quality can be affected if it is too loose or too tight.</li> <li>• Make sure the ribbon threads between the hammerbank cover and ribbon mask, as shown on the ribbon path diagram on the pedestal models. Turn the ribbon cartridge knob clockwise to ensure that the ribbon tracks correctly in the ribbon path.</li> <li>• Be sure to use an approved ribbon.</li> </ul>
Torn or damaged forms	<ul style="list-style-type: none"> <li>• Reset the forms thickness lever for thicker paper.</li> <li>• Adjust the paper tension horizontally by moving the right tractor. Too high a paper tension can cause tearing of the tractor feed holes.</li> <li>• Check the paper slot for foreign material.</li> <li>• For thick, multipart forms, set the OPEN PLATEN @ BOF to enable. Refer to the Printer Control Menu in the Administrator's Manual.</li> </ul>
Loss of forms position	<ul style="list-style-type: none"> <li>• Set the forms thickness lever for thicker paper.</li> </ul>
Lost dots (incompletely formed characters) Horizontally or vertically misaligned character positions Erratic character height Vertically misaligned print	<ul style="list-style-type: none"> <li>• Lower the forms thickness lever.</li> <li>• Adjust the paper tension horizontally by moving the right tractor. Print quality can be affected if it is too loose or too tight.</li> <li>• Clear the paper path of any obstructions.</li> <li>• If problems persists, contact a service representative.</li> </ul>

## Diagnostics for EXX, BAD NVM, or ILL NVM Errors

If the printer displays LCD error messages such as 'E03E DSI CXIWX', "BAD NVM", or "ILL NVM", reboot the printer (turn power on and off) and continue. If the problem persists, then invoke a diagnostic option that will capture the failure dump in a flash file that can be later uploaded from PrintNet Enterprise Suite and sent to Printronix Customer Support Center for analysis (see Appendix F, page 323).

This diagnostic option must be enabled for the printer to capture the information. If you choose to perform this diagnostic perform the following procedure:

1. Within the DIAGNOSTICS section, set the Auto Dump menu to Enable.
2. When the failure happens, reboot the printer and wait for it to power up again.
3. Within the ADVANCED USER section, go to the Main File System submenu and then to View File List.

4. Verify that files 'autodmp1' or 'autodmp2' are present in the file list.
5. If present, use PrintNet Enterprise Suite to upload these files to your host computer.
6. Contact Printronix Customer Support Center and send them the files along with the printer's configuration printout. Refer to the *PrintNet Enterprise Suite User's Manual* on how to accomplish these tasks.

## Fault Messages (ASCII in Alphabetical Order)

If a fault condition occurs in the printer, the status indicator on the control panel flashes on and off, and the message display indicates the specific fault. Fault messages are summarized in alphabetical order in Table 23. These error messages are used in ASCII products.

Displayed faults fall into one of two categories:

- Operator correctable
- Field service required

For the operator-correctable faults, follow the suggested solution in Table 23. After correcting the displayed fault, press the **CANCEL** key to clear the error message and status indicator and resume printing. If the fault message reappears, contact your authorized service representative.

**NOTE:** The *Maintenance Manual* provides more detailed information and procedures for resolving fault conditions. However, many of the procedures described there must be performed only by your authorized service representative.

### Fault Messages Requiring Field Service Attention

If a fault is not correctable by the operator, the fault message is followed by an asterisk (\*). This usually indicates that an authorized service representative is needed. You may try two steps to clear the fault before calling your authorized service representative:

1. Set the printer power switch to O (Off), wait 15 seconds, then turn the printer on again. Run your print job again. If the message does not appear, it was a false indication and no further attention is required.
2. If the message reappears, press the **CANCEL** key. If the message disappears, it was a false indication and no further attention is required. If the message reappears, call your authorized service representative.

**Table 23 LCD Message Troubleshooting Table (ASCII)**

<b>Displayed Message</b>	<b>Can User Correct?</b>	<b>Explanation</b>	<b>Solution</b>
12 VOLT FAILED*	No	The power supply 12 volt output has failed.	Contact your authorized service representative. <sup>1</sup>
B12 ERROR: PROGRAM MISSING*	Yes	The printer does not see a program in flash memory.	There is no program in printer memory. Download printer firmware again.
B13 ERROR: NOT COMPATIBLE*	No	Attempting to download a program that is not compatible with the printer.	Cycle power to see if the message clears, if not, contact your authorized service representative. <sup>1</sup>
B20 STATUS :00% DOWNLOAD MODE	No	Status message informing the operator that software is being downloaded. Percentage figure indicates approximate amount loaded into the printer.	No action is required.
B21 STATUS: PRINTER RESET	No	Status message informing the operator that the printer is undergoing a system reset.	No action is required.
B22 ERROR: DECOMPRESS SIZE*	No	FLASH memory has not passed boot initialization tests.	Cycle power to see if the message clears, if not, contact your authorized service representative. <sup>1</sup>
B23 ERROR: DECOMPRESS CKSUM*	No	FLASH memory has not passed boot initialization tests.	Cycle power to see if the message clears, if not, contact your authorized service representative. <sup>1</sup>
B30 STATUS: INITIALIZING.. .	N/A	Status message: the printer is running its initialization routines after startup and successful memory tests.	No action is required.
B50 STATUS: PANEL CODE BAD	No	Saved version of Panel Code is corrupt.	Reload released Firmware.
B51 STATUS: XX% LOADING...	No	Status message: printer boot-up routines are loading printer system software into flash memory and SDRAM.	No action required.
Bxx ERROR: NO DOWNLOADER FOUND	No	No Downloader was found while downloading a file.	Reload released Firmware.

**Table 23 LCD Message Troubleshooting Table (ASCII)**

<b>Displayed Message</b>	<b>Can User Correct?</b>	<b>Explanation</b>	<b>Solution</b>
BAD NVM CALL 1 BAD NVM CALL 2 BAD NVM CALL 3 BAD NVM CALL 4 BAD NVM CALL A	Yes	Printer firmware code error with the Novram module that stores configurations and statistics.	<ol style="list-style-type: none"> <li>1. Cycle power. Run the print job again. If the message appears, load the latest emulation software.</li> <li>2. Cycle power. Run the print job again. If the message appears again, record the exact display message, follow the instructions on page 252, Diagnostics for EXX, BAD NVM, or ILL NVM Errors, and contact your authorized service representative.<sup>1</sup></li> </ol>
x/y BARCODES / Not Found	Yes	Printer detects fewer barcodes than the set value for "Barcodes on Page" menu option. x represents the number of barcodes not found, and y represents the "Barcodes on Page" value.	Press the ONLINE key.
BUFFER OVERRUN	Yes	The print buffer has overflowed on a serial interface. The printed output may contain random * (asterisk) characters. Make a configuration printout.	Verify that the printer matches the host serial interface configuration settings for Data Protocol, Baud Rate, Data Bits, Stop Bits, Parity, Data Terminal Ready, and Request to Send. Set printer serial interface parameters to match those of the host.
CARTRIDGE AT END POINT Change Cart	Yes	Integrated Print Management System software has determined that the cartridge ribbon is out of ink.	Install a new cartridge.
CLEAR PAPER JAM	Yes	No paper motion.	Clear jam and reload paper. If this message recurs, contact your authorized service representative. <sup>1</sup>

**Table 23 LCD Message Troubleshooting Table (ASCII)**

<b>Displayed Message</b>	<b>Can User Correct?</b>	<b>Explanation</b>	<b>Solution</b>
CLEARING PROGRAM FROM FLASH	No	Status message: emulation software successfully loaded into printer RAM and the checksum matched. The old program is now being deleted from flash memory.	No action is required.
CLOSE PLATEN	Yes	The platen lever is open.	Close the platen lever.
COIL HOT ERR 1 COIL HOT ERR 2	No	One or more hammer coils are overheating.	Contact your authorized service representative. <sup>1</sup>
COIL TEMP FAIL	Yes	The coil temperature was never set or the attempt to set it did not result in correct numbers.	Allow printer to cool completely, then set coil temperature. If message continues to display, contact your authorized service representative. <sup>1</sup>
CARTRIDGE CONNECTION ERROR See User Manual	No	The hardware cannot communicate properly with the cartridge.	<ol style="list-style-type: none"> <li>1. Make sure the ribbon cartridge is seated properly.</li> <li>2. Remove and replace the ribbon cartridge if necessary.</li> <li>3. Contact your authorized service representative.<sup>1</sup></li> </ol>
CARTRIDGE INCOMPATIBLE Use correct cart	Yes	An incompatible ribbon cartridge was installed in the printer.	Install a cartridge designed for this printer.
CARTRIDGE MISSING Install new cart Press ONLINE	Yes	The ribbon cartridge is missing or installed improperly.	<ol style="list-style-type: none"> <li>1. Make sure a ribbon cartridge is installed in the printer.</li> <li>2. Make sure the ribbon cartridge is seated properly.</li> <li>3. Remove and replace the cartridge if necessary.</li> <li>4. Contact your authorized customer service representative.<sup>1</sup></li> </ol>



**Table 23 LCD Message Troubleshooting Table (ASCII)**

<b>Displayed Message</b>	<b>Can User Correct?</b>	<b>Explanation</b>	<b>Solution</b>
CARTRIDGE NOT SEATED Re-install Cart	Yes	The ribbon cartridge is not properly positioned.	<ol style="list-style-type: none"> <li>1. Make sure a ribbon cartridge is installed in the printer.</li> <li>2. Make sure the ribbon cartridge is seated properly.</li> <li>3. Remove and replace the cartridge if necessary.</li> <li>4. Contact your authorized customer service representative.<sup>1</sup></li> </ol>
CARTRIDGE/REGION X MISMATCH Use Correct Cart	Yes	The incorrect cartridge type is being used for the printer. "X" indicates the region of the printer.	Install Region X ribbon cartridge in the printer. <b>NOTE:</b> Specify the region of the printer when ordering ribbons.
CARTRIDGE/ SHUTTLE MISMATCH Use Correct Cart	Yes	This message displays when an Extended Life Cartridge is mounted on a 500 lpm printer.	Install Standard Life Cartridge.
CARTRIDGE/TIPSIZE MISMATCH Use Correct Cart	Yes	The incorrect cartridge type is being used for the printer.	Install the correct ribbon cartridge type in the printer.
CATASTROPHIC ERROR	No	Fatal error in printer.	Contact your authorized customer service representative. <sup>1</sup>
D50 STATUS UPGRADING PANEL	No	Status message: The printer is upgrading the panel, where %XX represents the percentage completed.	No action is required.
D51 STATUS PROGRAMMING DONE	No	Status message: The printer is loading firmware, where %XX represents the percentage completed.	No action is required.
DIAGNOSTIC PASSED	No	Status message: the printer passed its memory and hardware initialization tests.	No action is required.
DO NOT POWER OFF	No	Status message: The printer is performing an operation that must be completed before you can cycle power.	No action is required, but do not power off the printer until the operation is complete.

**Table 23 LCD Message Troubleshooting Table (ASCII)**

Displayed Message	Can User Correct?	Explanation	Solution
DP FIFO Busy*	Yes	There is a timing problem in the Engine Controller firmware.	<ol style="list-style-type: none"> <li>1. Cycle power. Run the print job again. If the message appears, download the emulation software again.</li> <li>2. Cycle power. Run the print job again. If the message appears again, contact your authorized service representative.<sup>1</sup></li> </ol>

**Table 23 LCD Message Troubleshooting Table (ASCII)**

Displayed Message	Can User Correct?	Explanation	Solution
<p>E00 EXE @ ADDR0  E01A TYPE 0x40  E01B TYPE 0x60  E02 MACHINE CHK  E03A DSI HASH L  E03B DSI HASH S  E03C DSI BAT PL  E03D DSI BAT PS  E03E DSI CXIWX  E03F DSI CXOWX  E03G DSI ECXIWX  E03H DSI ECXOWX  E04A ISI NO TRA  E04B ISI DIRECT  E04C ISI PROTEC  E06 NOT ALIGNED  E07 ILLEGAL INS  E08 FLOATINGPNT  E12 SYSTEM CALL  E13 TRACE INT  E16 ITRANS MISS  E17 DLOAD MISS  E18 DSTORE MISS  E19 BREAKPOINT  E20 SYS MANAGE  E30 DEBUGGER  E31A EVENT 0 BP  E31B EVENT 1 BP  E31C EVENT 2 BP  E31D EVENT 3 BP  E31E EVENT 4 BP  E31F EVENT 5 BP  E31G EVENT 6 BP  E31H EVENT 7 BP  E32A CND 0 BP  E32B CND 1 BP  E32C CND 2 BP  E32D CND 3 BP  E32E CND 4 BP  E32F CND 5 BP  E32G CND 6 BP  E32H CND 7 BP  E33 WRITE BP  E34 TRACE CMPLT  E99 UNKNOWN INT</p> <p>See User Manual</p>	<p>Yes</p>	<p>An illegal or unsupported instruction was attempted in the application program.</p>	<ol style="list-style-type: none"> <li>1. Cycle Power. Run the print job again. If the message appears, load the latest emulation software.</li> <li>2. Cycle power. Run the print job again. If the message appears again, record the exact display message, follow the instructions on page 253, and contact your authorized service representative.<sup>1</sup></li> </ol>
<p>E-Net Test Unavailable</p>	<p>Yes</p>	<p>The ethernet did not initialize correctly.</p>	<p>Cycle power. Wait for “E-Net Ready” to display, then retry operation. If it still fails, contact your authorized service representative.<sup>1</sup></p>

**Table 23 LCD Message Troubleshooting Table (ASCII)**

<b>Displayed Message</b>	<b>Can User Correct?</b>	<b>Explanation</b>	<b>Solution</b>
ERROR OCCURRED FLUSHING QUEUES*	Yes	An interim message that displays while the printer discards host data it cannot use because a fault condition exists. While this message displays, the asterisk (*) rotates.	Wait. When the asterisk (*) stops rotating, a different fault message will appear: troubleshoot the final message.
ERROR NOR FLASHED WAS NOT CLEARED	No	Problem programming Boot Code.	Contact your authorized service representative. <sup>1</sup>
ERROR: DC PROGRAM NOT VALID	Yes	The printer cannot find the data controller program or the validation checksum is corrupt.	Download the program again. If the message appears, contact your authorized service representative. <sup>1</sup>
ERROR: LOCKED SN=nnnnnnnnnnnnnnnnnn n	No	nnnnnnnnnnnnnnnnnn n is the serial number of the printer's security key. The SPX serial number does not match the printer's serial number and cannot be used with the printer.	Contact your authorized service representative. <sup>1</sup>
ERROR: NVRAM FAILURE	No	The non-volatile SRAM on the controller board has failed.	Contact your authorized service representative. <sup>1</sup>
ERROR: PROGRAM NOT COMPATIBLE	Yes	The printer is not compatible with the downloaded program.	Use the correct emulation software options(s) for this printer model.
ERROR: PROGRAM NOT VALID	Yes	The printer does not see a program in flash memory.	There is no program in printer memory. Download the emulation.
ERROR: SECURITY KEY NOT DETECTED	No	The security key is not present or failed.	Contact your authorized service representative. <sup>1</sup>
ERROR: WRONG CHECKSUM	No	The printer received the complete program but the checksum did not match. The data may have been corrupted during downloading.	Contact your authorized service representative. <sup>1</sup>
ERROR: WRONG OEM	No	The SPX inserted in the debug port is not intended for this model printer or this OEM.	Contact your authorized service representative. <sup>1</sup>

**Table 23 LCD Message Troubleshooting Table (ASCII)**

<b>Displayed Message</b>	<b>Can User Correct?</b>	<b>Explanation</b>	<b>Solution</b>
ERROR: WRONG PRINTER TYPE	No	The SPX inserted in the debug port is not intended for this model printer or this OEM.	Contact your authorized service representative. <sup>1</sup>
ETHERNET DETECTED	N/A	Status message indicating that the Network Interface Card has established connection.	No action is required.
ETHERNET INITIALIZING	No	Status message: the internal Network Interface Card is processing the boot procedure. (May occur with older versions of microcode.)	No action is required.
EXCEPTION ERROR	No	An EXCEPTION INTERRUPT has occurred.	Contact your authorized service representative. <sup>1</sup>
EXCESS RIBBON WEAR Install New RBN	Yes	Status message that displays when ribbon reaches end of life, whether the Integrated Print Management System is enabled or not.	Install a new ribbon.
EXHAUST FAN FLT (Cabinet model only)	Yes	Sensor cannot detect current in fan circuit.	Power off the printer and remove the paper path (see <i>Maintenance Manual</i> ). Check that the fan cable connector is connected. Check for obstruction of vents and fan airway, and remove any obstructions. Check for items beneath the printer blocking cabinet vents. Power back on the printer. If this message appears again, contact your authorized service representative. <sup>1</sup>
FIRMWARE ERROR*	No	Application software tried to perform an illegal printer function or damaged memory detected on the controller board.	Contact your authorized service representative. <sup>1</sup>
FLASH: CHECK RETURN	No	Printer encountered an error while trying to program Flash memory.	Contact your authorized service representative. <sup>1</sup>

**Table 23 LCD Message Troubleshooting Table (ASCII)**

<b>Displayed Message</b>	<b>Can User Correct?</b>	<b>Explanation</b>	<b>Solution</b>
FLASH: WAS NOT CLEARED	No	Printer encountered an error while trying to program Flash memory.	Contact your authorized service representative. <sup>1</sup>
FLASH: WRITE ERROR # 2	No	Printer encountered an error while trying to program Flash memory.	Contact your authorized service representative. <sup>1</sup>
FM HEADER ERROR*	No	Frame Header Error. Application software has violated header parameters.	Contact your system administrator.
FRAMING ERROR	Yes	The printed output may contain random ! (exclamation point) characters.	Make a configuration printout. Set printer serial interface parameters to match host configuration settings for Data Protocol, Baud Rate, Data Bits, Stop Bits, Parity, Data Terminal Ready, and Request to Send.
GENERATING XX% NAND FLASH TABLE	No	NAND FLASH is being read and system tables are being initialized.	No action is required.
H00: PCI SLOT ? See User Manual	No	The controller board is not communicating with a PCI card. This could indicate a bad PCI card, poor connection, or problem in the PCI bus.	Contact your authorized service representative. <sup>1</sup>
H01: PCI J12 See User Manual	No	The controller board is not communicating with the PCI card in PCI slot J12. This could indicate a bad PCI card, poor connection, or problem in the PCI bus.	Contact your authorized service representative. <sup>1</sup>

**Table 23 LCD Message Troubleshooting Table (ASCII)**

<b>Displayed Message</b>	<b>Can User Correct?</b>	<b>Explanation</b>	<b>Solution</b>
<Online, etc...> Half Speed Mode	No	Status message: The controller samples the operating temperature of key components of the print mechanism. When higher than normal temperatures are sensed, the print speed is automatically reduced by 50% and the message sent the LCD. When the components cool down, the print speed returns to 100% and the message clears.	No action is required. If the message appears often, contact your authorized service representative. <sup>1</sup>
HAMMER COIL BAD* #, #, #, ...etc	No	Hammer coil # failed current test at power up.	Contact your authorized service representative. <sup>1</sup>
HAMMER DRIVER CIRCUIT BAD*	No	Driver Circuit Bad. The hammer coil count test failed.	Contact your authorized service representative. <sup>1</sup>
HAMMERBANK NOT INSTALLED*	No	Hammer Bank Not Installed. Self-test routines do not detect hammer coils at printer start-up.	Contact your authorized service representative. <sup>1</sup>
HMR BANK FAN FLT	Yes	Sensor cannot detect current in fan circuit.	Check that fan cable is connected. Check for obstruction of vents and fan airway; remove any obstructions. Check for items beneath the printer blocking cabinet vents. Power back on the printer. If this message recurs, contact your authorized service representative. <sup>1</sup>
ILL EXT BUS ACC*	No	Illegal External Bus Access. Firmware error on the controller board.	Contact your authorized service representative. <sup>1</sup>

**Table 23 LCD Message Troubleshooting Table (ASCII)**

<b>Displayed Message</b>	<b>Can User Correct?</b>	<b>Explanation</b>	<b>Solution</b>
ILL NVM VALUE 5 ILL NVM VALUE 6 ILL NVM VALUE 7	Yes	Illegal value was stored into the Novram module.	<ol style="list-style-type: none"> <li>1. Cycle power. Run the print job again. If the message appears, load the latest emulation software.</li> <li>2. Cycle power. Run the print job again. If the message appears again, record the exact display message, follow the instructions on page 252, Diagnostics for EXX, BAD NVM, or ILL NVM Errors, and contact your authorized service representative.<sup>1</sup></li> </ol>
ILLGL OPR ACCSS*	No	Illegal Operand Accessed. Firmware error on controller board.	Contact your authorized service representative. <sup>1</sup>
INITIALIZING...	Yes	This message indicates the printer is beginning its initialization process.	No action is required.
INTAKE FAN CHECK	Yes	Sensor cannot detect current in fan circuit.	Cycle power. If the message appears, press CLEAR. If the message does not clear, contact your authorized service representative. <sup>1</sup>
INTERRUPT UNUSED VECTOR 00	No	The controller board receives an interrupt it does not understand. The problem can be created by electrical noise, by a software problem, or by a hardware problem.	Cycle power. If this message occurred once and never again, you can ignore it. If the message reappears or appears consistently, contact your authorized service representative. <sup>1</sup>
LO DRV. SHORT *	No	Lower Driver Short. Circuit(s) on the hammer bank or in the hammer bank power cable shorted to ground.	Contact your authorized service representative. <sup>1</sup>
LOAD PAPER	Yes	Printer is out of paper.	Load paper and press CLEAR.
LOADING PROGRAM FROM PORT XX%	No	Status message: the new emulation program is loading into printer RAM. XX% indicates how much of the program has loaded.	No action is required.



**Table 23 LCD Message Troubleshooting Table (ASCII)**

<b>Displayed Message</b>	<b>Can User Correct?</b>	<b>Explanation</b>	<b>Solution</b>
LOADING PROGRAM INTO FLASH	No	The printer has deleted the previous program from flash memory and is loading the new program into flash memory.	No action is required.
NEW SPX DETECTED PRESS ENTER	No	The printer detects an SPX installed at the debug port and the SPX is valid for the printer.	Contact your authorized service representative. <sup>1</sup>
NON VOLATILE MEMORY FAILED	No	Large emulations reduce the amount of space available for saving configurations, which means that sometimes fewer than eight configurations can be saved.	Contact your authorized service representative. <sup>1</sup>
ONLINE	N/A	Printer state message: printer is online and in communication with host.	No action is required.
PANEL BAD CHECKSUM	No	Panel Code has a bad Checksum.	Reload released firmware.
PAP BAD TABLE*	No	Paper Bad Table. The paper feed process on the controller board has a corrupted table.	Contact your authorized service representative. <sup>1</sup>
PAP FD DRVR CIR* See Manual	No	Paper Feed Driver Circuit. The paper feed driver circuit on the controller board is drawing too much current.	Contact your authorized service representative. <sup>1</sup>
PAP FIFO OVERFL*	No	Paper First In First Out Overflow. Firmware error on controller board.	Contact your authorized service representative. <sup>1</sup>
PAP FIFO UNDRFL*	No	Paper First In First Out Underflow. Firmware error on controller board.	Contact your authorized service representative. <sup>1</sup>
PAP ILLGL ST*	No	Paper Illegal State. Firmware error on controller board.	Contact your authorized service representative. <sup>1</sup>
PAP INVLD CMD*	No	Paper Invalid Command. Firmware error on controller board.	Contact your authorized service representative. <sup>1</sup>

**Table 23 LCD Message Troubleshooting Table (ASCII)**

<b>Displayed Message</b>	<b>Can User Correct?</b>	<b>Explanation</b>	<b>Solution</b>
PAP INVLD PARM*	No	Paper Invalid Parameter. Firmware error on controller board.	Contact your authorized service representative. <sup>1</sup>
PAPER REQUESTED Install A4	Yes	A paper size mismatch is detected.	Check the paper size setting and if necessary, load new media and change the paper size menu option.
PARITY ERROR	Yes	The printed output may contain a random ? (question mark) characters.	Check your printer serial interface parameter settings; if necessary, adjust them so that they match the settings of the attached host.
PLAT INV CMD*	No	Platen Invalid Command. Firmware error on controller board.	Contact your authorized service representative. <sup>1</sup>
PLAT INV PARM*	No	Platen Invalid Parameter. Firmware error on controller board.	Contact your authorized service representative. <sup>1</sup>
PLAT INV STATE*	No	Platen Invalid State. Firmware error on controller board.	Contact your authorized service representative. <sup>1</sup>
PLEASE WAIT... RESET IN PROGRESS	N/A	Status message: the printer finished loading the program into flash memory and is automatically resetting itself.	No action is required.
POWER SUPPLY HOT	Yes	Power supply sensors report high temperatures.	Check printer environment. If hot or dusty, relocate printer. Contact your authorized service representative if this occurs frequently. <sup>1</sup>
PRINTER HOT	Yes	This message indicates internal temperatures of 80° Celsius or higher (176° Fahrenheit).	Check printer environment. If hot or dusty, relocate printer. Contact your authorized service representative if this occurs frequently. <sup>1</sup>
PRINTER UNDER REMOTE CONTROL	No	Status message: The printer is under the control of PrintNet Enterprise (PNE) remote management software.	No action is required.
PROCESSOR HALTED EC_FAULT_RTSYS2	No	Real-time System Firmware error on controller board.	Contact your authorized service representative. <sup>1</sup>

**Table 23 LCD Message Troubleshooting Table (ASCII)**

<b>Displayed Message</b>	<b>Can User Correct?</b>	<b>Explanation</b>	<b>Solution</b>
PROTECTED INSTR*	No	Protected Instruction. Firmware error on controller board.	Contact your authorized service representative. <sup>1</sup>
PS/PDF ERROR: CHECK ERROR	Yes	Fault displayed when Postscript/PDF failed to process a job. One or more of the following errors were detected: Type Check, Limit Check, Range Check, or No Current Point Defined.	Check the Postscript/PDF job for syntax (Postscript) errors. Clear the fault. Postscript/PDF will continue with the next job.
PS/PDF ERROR: DICTIONARY ERROR	Yes	Fault displayed when Postscript/PDF failed to process a job. One or more of the following errors were detected: Dictionary Full, Dictionary Stack Overflow, or Dictionary Stack Underflow.	Check the Postscript/PDF job for syntax (Postscript) errors. Clear the fault. Postscript/PDF will continue with the next job.
PS/PDF ERROR: INVALID ACCESS	Yes	Fault displayed when Postscript/PDF failed to process a job. One or more of the following errors were detected: Invalid Access, Invalid Font, or Invalid Exit.	Check the Postscript/PDF job for syntax (Postscript) errors. Clear the fault. Postscript/PDF will continue with the next job.
PS/PDF ERROR: I/O ERROR	Yes	Fault displayed when Postscript/PDF failed to process a job. One or more of the following errors were detected: I/O Error, Invalid File Access, Undefined File, Interrupt, or Time Out.	Check the Postscript/PDF job for syntax (Postscript) errors. Clear the fault. Postscript/PDF will continue with the next job.
PS/PDF ERROR: JOB ABORTED	Yes	Fault displayed when Postscript/PDF failed to process a job, e.g. an unsupported command or a large job which requires more DRAM to process.	Clear the fault. Postscript/PDF will continue with the next job.

**Table 23 LCD Message Troubleshooting Table (ASCII)**

<b>Displayed Message</b>	<b>Can User Correct?</b>	<b>Explanation</b>	<b>Solution</b>
PS/PDF ERROR: STACK ERROR	Yes	Fault displayed when Postscript/PDF failed to process a job. One or more of the following errors were detected: Stack Overflow, Stack Underflow, Exec Stack Overflow, or Invalid Restore.	Check the Postscript/PDF job for syntax (Postscript) errors. Clear the fault. Postscript/PDF will continue with the next job.
PS/PDF ERROR: SYNTAX ERROR	Yes	Fault displayed when Postscript/PDF failed to process a job. One or more of the following errors were detected: Syntax Error, Unmatched Mark, Undefined, Undefined Results, or Unknown Error.	Check the Postscript/PDF job for syntax (Postscript) errors. Clear the fault. Postscript/PDF will continue with the next job.
PWR SUPP VOLT *	No	Power Supply Voltage. The power supply has failed.	Replace power supply board.
REMOVE USED SPX THEN PRESS ENTER	No	Status message: An SPX is depleted because it has successfully reprogrammed the security key on the controller board.	Contact your authorized service representative. <sup>1</sup>
RESTORING BOOT CODE	No	Normal download initialization message.	No action is required.
RIB INVLD CMD* See User Manual	Yes	Ribbon Invalid Command. Firmware error on the controller board.	Cycle power. Run the print job again. If the message appears, download the emulation software again. If the message appears again, contact your authorized service representative. <sup>1</sup>
RIBBON STALL	Yes	The controller board does not detect ribbon movement.	Check the ribbon path for jams. Turn the Ribbon Tension Knob clockwise a few rotations. If necessary, install a new ribbon.
RIBBON UNDER 2% Change RBN Soon	Yes	Status message indicating the Integrated Print Management System is enabled and ribbon ink level is 2%.	Install a new ribbon.

**Table 23 LCD Message Troubleshooting Table (ASCII)**

<b>Displayed Message</b>	<b>Can User Correct?</b>	<b>Explanation</b>	<b>Solution</b>
SD CARD ERROR Remove SD Card	Yes	The printer has been powered up with a card in the SD slot, but the card is not functioning properly. The card could be a compact flash card or a non-supported card.	Power down, reseal card, and power up again. If error persists, power down, remove card, and try another card.
SD FILE EXISTS Enable Overwrite	Yes	A write operation to the SD has failed because the file already exists on the SD card and the overwriting of existing files is disabled.	Enable overwriting of files on the SD using the overwrite files menu.
SD FILESYS FULL Delete Files	Yes	The SD file system is completely full.	Delete files on the SD card to make space.
SD FILESYS FULL File Too Big	Yes	A write operation to the SD has failed because the file is too big to fit in the remaining space on the SD card.	Delete files on the SD card to make space.
SD FILESYS WRITE Check SD	Yes	A write operation to the SD has failed for an unknown reason.	Ensure that the SD card is inserted correctly and that the SD card is a supported SDHC card.
SD INSERTED Reboot Printer	Yes	The SD card has been inserted after the printer was already powered up.	Turn off the printer and insert the SD card only when the printer is not powered on.
SD NOT FOUND Insert SD Card Pwr Off Printer	Yes	A write operation to the SD could not be performed because the SD card was not detected.	Ensure that an SD card is inserted correctly and that the SD card is a supported SDHC card.
SD READING Do not Remove	Yes	The SD card is currently reading files.	Wait until reading completes.
SD REMOVED Reboot Printer	Yes	The SD card has been removed after the printer was already powered up.	Turn off the printer and remove the SD card only when the printer is off.
SD WRITE FAIL WRITE PROTECTED Check SD Card	Yes	A write operation to the SD has failed because the SD card is write protected.	Ensure that the write protect tab on the SD card is not active. If the write protect tab is not active, use another SD card.
SD WRITING Do not Remove	Yes	The SD card is currently writing or erasing files.	Wait until the write or erase operation completes.

**Table 23 LCD Message Troubleshooting Table (ASCII)**

<b>Displayed Message</b>	<b>Can User Correct?</b>	<b>Explanation</b>	<b>Solution</b>
SDSC CARD NOT SUPPORTED Remove SD Card	Yes	The printer has been powered up with an SDSC card, and SDSC cards (< 4 GB) are not supported.	Power down, remove SD card, and insert an SDHC card in the printer.
SECURITY VIOLATION*	No	Security code of PAL on controller board does not match code of firmware on the controller board.	Contact your authorized service representative. <sup>1</sup>
SECURITY KEY NOT DETECTED	No	The security key is not present or has failed.	Contact your authorized service representative. <sup>1</sup>
SF ERROR	No	Structured Field Error. Application software has violated structured data field parameters.	Not a printer problem. Have the system administrator correct applications data or configuration.
SHUT DRVR CIR* See User Manual	No	The shuttle driver circuit on the controller board is drawing too much current.	Contact your authorized service representative. <sup>1</sup>
SHUTL INV CMD*	No	Shuttle Invalid Command. Firmware error on controller board.	Contact your authorized service representative. <sup>1</sup>
SHUTL INV PARM*	No	Shuttle Invalid Parameter. Firmware error on controller board.	Contact your authorized service representative. <sup>1</sup>
SHUTL OVR SPEED*	No	The shuttle is oscillating too rapidly.	Contact your authorized service representative. <sup>1</sup>
SHUTTLE JAM	Yes	No shuttle movement or shuttle moving at the wrong speed.	Check for obstruction to shuttle, a twisted ribbon, or platen lever closed too tightly. If fault source is not apparent, contact your authorized service representative. <sup>1</sup>
SHUTTLE STALL	Yes	The shuttle is not moving.	Set the platen lever to match the thickness of paper, but not too tightly. Check and adjust the platen gap. Inspect the ribbon mask for deformation that snags and interferes with shuttle movement. If fault source is not apparent, contact your authorized service representative. <sup>1</sup>

**Table 23 LCD Message Troubleshooting Table (ASCII)**

<b>Displayed Message</b>	<b>Can User Correct?</b>	<b>Explanation</b>	<b>Solution</b>
SHUTTLE TYPE NOT SUPPORTED*	No	The shuttle type was not detected at power-up or the shuttle installed in the printer is not supported by the firmware.	Contact your authorized service representative. <sup>1</sup>
SOFTWARE ERROR* CYCLE POWER	No	Application software tried to perform illegal printer function, or damaged logic circuits found on controller board.	Contact your authorized service representative. <sup>1</sup>
SPX FOUND, ERROR: KEY NOT DETECTED	No	The controller board does not have a security key.	Contact your authorized service representative. <sup>1</sup>
SPX NOT NEEDED OPTIONS ENABLED	No	The user has attempted to use the SPX to turn on printer options that are already enabled.	Contact your authorized service representative. <sup>1</sup>
TCB CORRUPTED*	No	Task Control Block Corrupted. Firmware error on controller board.	Contact your authorized service representative. <sup>1</sup>
TCP PORT BUSY	Yes	Error message reported by the Printer Manager when ethernet interface option is installed. The network address given in the printer properties was reached, but the printer port is busy.	Refer to the <i>Printronix P8000 Maintenance Manual</i> .
UP DRV. SHORT*	No	Upper Driver Short. Hammer driver circuits on the boards shorted to ground.	Cycle power to see if the message clears, if not, contact your authorized service representative. <sup>1</sup>
UPGRADED - REMOVE SPX Downld code if needed	No	Status message: An SPX has successfully upgraded the security key on the controller board.	Remove SPX and download code if needed.
WELD NOT DETECT See User Manual	No	The cartridge weld was not detected.	Contact your authorized service representative. <sup>1</sup>
WELD SNSR ERROR See User Manual	No	The cartridge sensor could not be calibrated.	<ol style="list-style-type: none"> <li>1. Make sure your cartridge is properly seated.</li> <li>2. Contact your authorized service representative.<sup>1</sup></li> </ol>

**Table 23 LCD Message Troubleshooting Table (ASCII)**

<b>Displayed Message</b>	<b>Can User Correct?</b>	<b>Explanation</b>	<b>Solution</b>
WELD SNSR MISSING See User Manual	Yes	The incorrect cartridge type is being used for the printer.	<ol style="list-style-type: none"> <li>1. Make sure the correct ribbon cartridge type is installed.</li> <li>2. Make sure the cartridge is properly seated.</li> <li>3. Contact your authorized service representative. <sup>1</sup></li> </ol>
XXXX CHECKING PATTERN	No	Running power on memory test.	No action is required.
XXXX MEMORY FAILURE	No	Memory in bank xxx has failed. Power on memory test.	Contact your authorized service representative. <sup>1</sup>
XXXX WRITING PATTERN	No	Running power on memory test.	No action is required.
<sup>1</sup> Before contacting an authorized service representative, power off the printer, wait 15 seconds, then power it back on and rerun your print job. If the message reappears, press CLEAR. If the fault message still displays, then contact your authorized service representative.			



## Fault Messages (H-Series with Numerical Prefix)

If a fault condition occurs in the printer, the status indicator on the control panel flashes on and off, and the message display indicates the specific fault. Fault messages are summarized in Table 24. Many of the error messages for H-Series have a numerical prefix to help the user find the description within this manual.

Displayed faults fall into one of two categories:

- Operator correctable
- Field service required

For the operator correctable faults, follow the suggested solution in Table 24. After correcting the displayed fault, press the **CLEAR** key to clear the error message and status indicator, and resume printing. If the fault message reappears, contact your authorized service representative.

**NOTE:** The Maintenance Manual provides more detailed information and procedures for resolving fault conditions. However, many of the procedures described there must be performed only by your authorized service representative.

### Fault Messages Requiring Field Service Attention

If a fault is not correctable by the operator, the fault message is followed by an asterisk (\*). This usually indicates that an authorized service representative is needed. You may try two steps to clear the fault before calling your authorized service representative:

1. Set the printer power switch to O (Off), wait 15 seconds, then turn the printer on again. Run your print job again. If the message does not appear, it was a false indication and no further attention is required.
2. If the message reappears, press the **CLEAR** key. If the message disappears, it was a false indication and no further attention is required. If the message reappears, call your authorized service representative.

**Table 24 LCD Message Troubleshooting Table (H-Series)**

<b>Displayed Message</b>	<b>Can User Correct?</b>	<b>Explanation</b>	<b>Solution</b>
000:SHUTTLE TYPE NOT SUPPORTED*	No	The shuttle type was not detected at power-up or the shuttle installed in the printer is not supported by the firmware.	Contact your authorized service representative. <sup>1</sup>
104:POWER SUPPLY HOT	Yes	Power supply sensors report high temperatures.	Check printer environment. If hot or dusty, relocate printer. Contact your authorized service representative if this occurs frequently. <sup>1</sup>
105:PRINTER HOT	Yes	This message indicates internal temperatures of 80° Celsius or higher (176° Fahrenheit).	Check printer environment. If hot or dusty, relocate printer. Contact your authorized service representative if this occurs frequently. <sup>1</sup>
401:BUFFER OVERRUN	Yes	The print buffer has overflowed on a serial interface. The printed output may contain random * (asterisk) characters. Make a configuration printout.	Verify that the printer matches the host serial interface configuration settings for Data Protocol, Baud Rate, Data Bits, Stop Bits, Parity, Data Terminal Ready, and Request to Send. Set printer serial interface parameters to match those of the host.
402:CLEAR PAPER JAM	Yes	No paper motion.	Clear jam and reload paper. If this message recurs, contact your authorized service representative. <sup>1</sup>
403:CLOSE PLATEN	Yes	The platen lever is open.	Close the platen lever.
409:FRAMING ERROR	Yes	The printed output may contain random ! (exclamation point) characters.	Make a configuration printout. Set printer serial interface parameters to match host configuration settings for Data Protocol, Baud Rate, Data Bits, Stop Bits, Parity, Data Terminal Ready, and Request to Send.
410:LOAD PAPER	Yes	Printer is out of paper.	Load paper and press <b>CLEAR</b> .
411:PARITY ERROR	Yes	The printed output may contain a random ? (question mark) characters.	Check your printer serial interface parameter settings; if necessary, adjust them so that they match the settings of the attached host.
414:RIBBON STALL	Yes	The controller board does not detect ribbon movement.	Check the ribbon path for jams. Turn the Ribbon Tension Knob clockwise a few rotations. If necessary, install a new ribbon.

**Table 24 LCD Message Troubleshooting Table (H-Series)**

<b>Displayed Message</b>	<b>Can User Correct?</b>	<b>Explanation</b>	<b>Solution</b>
415:SHUTTLE JAM	Yes	No shuttle movement or shuttle moving at the wrong speed.	Check for obstruction to shuttle, a twisted ribbon, or platen lever closed too tightly. If fault source is not apparent, contact your authorized service representative. <sup>1</sup>
418:RBN INK LOW Change RBN Soon	Yes	Status message indicating the Integrated Print Management System is enabled and ribbon ink level is 2%.	Install a new ribbon cartridge.
419:RBN INK OUT* Install New RBN	Yes	Integrated Print Management System software has determined that the ribbon is out of ink.	Install a new ribbon cartridge.
420:EXC RBN WEAR Install New RBN	Yes	Status message that displays when ribbon reaches end of life, whether the Integrated Print Management System is enabled or not.	Install a new ribbon cartridge.
423:USED CART Load New Cart	Yes	The sensor detects a ribbon that was previously declared to be at the end of its service life.	Install a new ribbon cartridge.
425:UNKNOWN RBN2 Install New RBN	Yes	The sensor detects a bar code, but the region code does not match the printer.	Install a new ribbon cartridge.
427:CRTG MISSING Install new cart Press ONLINE	Yes	The ribbon cartridge is missing or installed improperly.	<ol style="list-style-type: none"> <li>1. Make sure a ribbon cartridge is installed in the printer.</li> <li>2. Make sure the ribbon cartridge is seated properly.</li> <li>3. Remove and replace the cartridge if necessary.</li> <li>4. Contact your authorized customer service representative.<sup>1</sup></li> </ol>
428:CRTG COMM ER See User Manual	No	The hardware cannot communicate properly with the cartridge.	<ol style="list-style-type: none"> <li>1. Make sure the ribbon cartridge is seated properly.</li> <li>2. Remove and replace the ribbon cartridge if necessary.</li> <li>3. Contact your authorized service representative.<sup>1</sup></li> </ol>

**Table 24 LCD Message Troubleshooting Table (H-Series)**

<b>Displayed Message</b>	<b>Can User Correct?</b>	<b>Explanation</b>	<b>Solution</b>
432:CRT NOT SET	Yes	The ribbon cartridge is not correctly positioned.	<ol style="list-style-type: none"> <li>1. Make sure a ribbon cartridge is installed in the printer.</li> <li>2. Make sure the ribbon cartridge is seated properly.</li> <li>3. Remove and replace the cartridge if necessary.</li> <li>4. Contact your authorized customer service representative.<sup>1</sup></li> </ol>
435:NO WELD See User Manual	No	The cartridge weld was not detected.	Contact your authorized service representative. <sup>1</sup>
437:REG MISSING Use Correct RBN	Yes	The incorrect cartridge type is being used for the printer.	Install region X ribbon cartridge in the printer. <b>NOTE:</b> Specify the region of the printer when ordering ribbons.
438:TIP MISMATCH Use Correct RBN	Yes	The incorrect cartridge type is being used for the printer.	Install the correct ribbon cartridge type in the printer.
439:SHTL MISMATCH Use Correct RBN	Yes	This message displays when an Extended Life Ribbon is mounted on a 500 lpm printer.	Install Standard Life Ribbon.
445:SD INSERTED Reboot Printer	Yes	The SD card has been inserted after the printer was already powered up.	Turn off the printer and insert the SD card only when the printer is not powered on.
446:SD REMOVED Reboot Printer	Yes	The SD card has been removed after the printer was already powered up.	Turn off the printer and remove the SD card only when the printer is off.
447:SD FL EXIST Enable Overwrite	Yes	A write operation to the SD has failed because the file already exists on the SD card and the overwriting of existing files is disabled.	Enable overwriting of files on the SD using the overwrite files menu.
448:SD WRT. FAIL WRITE PROTECTED Check SD Card	Yes	A write operation to the SD has failed because the SD card is write protected.	Ensure that the write protect tab on the SD card is not active. If the write protect tab is not active, use another SD card.
449:SD FILE WRITE Check SD	Yes	A write operation to the SD has failed for an unknown reason.	Ensure that the SD card is inserted correctly and that the SD card is a supported SDHC card.

**Table 24 LCD Message Troubleshooting Table (H-Series)**

<b>Displayed Message</b>	<b>Can User Correct?</b>	<b>Explanation</b>	<b>Solution</b>
450:SD FILE FULL File Too Big	Yes	A write operation to the SD has failed because the file is too big to fit in the remaining space on the SD card.	Delete files on the SD card to make space.
451:SD NOT FOUND Insert SD Card Pwr Off Printer	Yes	A write operation to the SD could not be performed because the SD card was not detected.	Ensure that an SD card is inserted correctly and that the SD card is a supported SDHC card.
452:SD FILE FULL Delete Files	Yes	The SD file system is completely full.	Delete files on the SD card to make space.
453:SD READING Do not Remove	Yes	The SD card is currently reading files.	Wait until reading completes.
454:SD WRITING Do not Remove	Yes	The SD card is currently writing or erasing files.	Wait until the write or erase operation completes.
607:CTL VOLT FAIL*	No	Controller Voltage Failure. 15 V failure on the controller board.	Contact your authorized service representative. <sup>1</sup>
608:DRIVER CIRCUIT BAD	No	Driver Circuit Bad. The hammer coil count test failed.	Contact your authorized service representative. <sup>1</sup>
609:EXHAUST FAN CHECK (Cabinet model only)	Yes	Sensor cannot detect current in fan circuit.	Power off the printer and remove the paper path (see <i>Maintenance Manual</i> ). Check that the fan cable connector is connected. Check for obstruction of vents and fan airway, and remove any obstructions. Check for items beneath the printer blocking cabinet vents. Power back on the printer. If this message appears again, contact your authorized service representative. <sup>1</sup>
613: HAM. COIL BAD #, #, #, ...etc	No	Hammer coil # failed current test at power up.	Contact your authorized service representative. <sup>1</sup>
614:HAMMER BANK* NOT INSTALLED	No	Hammer Bank Not Installed. Self-test routines do not detect hammer coils at printer start-up.	Contact your authorized service representative. <sup>1</sup>

**Table 24 LCD Message Troubleshooting Table (H-Series)**

<b>Displayed Message</b>	<b>Can User Correct?</b>	<b>Explanation</b>	<b>Solution</b>
615:HAMMER FAN CHECK	Yes	Sensor cannot detect current in fan circuit.	Check that fan cable is connected. Check for obstruction of vents and fan airway; remove any obstructions. Check for items beneath the printer blocking cabinet vents. Power back on the printer. If this message recurs, contact your authorized service representative. <sup>1</sup>
617:LOWER DRIVER SHORT*	No	Lower Driver Short. Circuit(s) on the hammer bank or in the hammer bank power cable shorted to ground.	Contact your authorized service representative. <sup>1</sup>
619:PAPER FEED DRIVER CIRCUIT* See Manual	No	Paper Feed Driver Circuit. The paper feed driver circuit on the controller board is drawing too much current.	Contact your authorized service representative. <sup>1</sup>
620:POWER VOLT CHECK*	No	Power Supply Voltage. The power supply has failed.	Replace power supply board.
622:SHUTTLE DRIVER CIRCUIT*	No	The shuttle driver circuit on the controller board is drawing too much current.	Contact your authorized service representative. <sup>1</sup>
624:UPPER DRIVER SHORT*	No	Upper Driver Short. Hammer driver circuits on the boards shorted to ground.	Cycle power to see if the message clears, if not, contact your authorized service representative. <sup>1</sup>
702:FIRMWARE ERROR*	No	Application software tried to perform an illegal printer function or damaged memory detected on the controller board.	Contact your authorized service representative. <sup>1</sup>
703:ILLEGAL EXTERNAL BUS ACC*	No	Illegal External Bus Access. Firmware error on the controller board.	Contact your authorized service representative. <sup>1</sup>
704:ILLEGAL INSTRUCTION ACC*	No	Illegal Instruction Accessed. Firmware error on the controller board.	Contact your authorized service representative. <sup>1</sup>
705:ILLEGAL OPERAND ACCESS*	No	Illegal Operand Accessed. Firmware error on controller board.	Contact your authorized service representative. <sup>1</sup>

**Table 24 LCD Message Troubleshooting Table (H-Series)**

<b>Displayed Message</b>	<b>Can User Correct?</b>	<b>Explanation</b>	<b>Solution</b>
706:PAP BAD TABLE*	No	Paper Bad Table. The paper feed process on the controller board has a corrupted table.	Contact your authorized service representative. <sup>1</sup>
708:PAPER FIFO OVERFLOW*	No	Paper First In First Out Overflow. Firmware error on controller board.	Contact your authorized service representative. <sup>1</sup>
709:PAPER FIFO UNDERFLOW*	No	Paper First In First Out Underflow. Firmware error on controller board.	Contact your authorized service representative. <sup>1</sup>
710:PAP ILLGL ST*	No	Paper Illegal State. Firmware error on controller board.	Contact your authorized service representative. <sup>1</sup>
712:PAP INVLD CMD*	No	Paper Invalid Command. Firmware error on controller board.	Contact your authorized service representative. <sup>1</sup>
713:PAP INVLD PARM*	No	Paper Invalid Parameter. Firmware error on controller board.	Contact your authorized service representative. <sup>1</sup>
717:PLAT INV CMD*	No	Platen Invalid Command. Firmware error on controller board.	Contact your authorized service representative. <sup>1</sup>
718:PLAT INV PARM*	No	Platen Invalid Parameter. Firmware error on controller board.	Contact your authorized service representative. <sup>1</sup>
719:PLAT INV STATE*	No	Platen Invalid State. Firmware error on controller board.	Contact your authorized service representative. <sup>1</sup>
720:PROTECTED INSTRUCTION*	No	Protected Instruction. Firmware error on controller board.	Contact your authorized service representative. <sup>1</sup>
721:RIB INVLD CMD* See User Manual	Yes	Ribbon Invalid Command. Firmware error on the controller board.	Cycle power. Run the print job again. If the message appears, download the emulation software again. If the message appears again, contact your authorized service representative. <sup>1</sup>
723:SHUTL INV CMD*	No	Shuttle Invalid Command. Firmware error on controller board.	Contact your authorized service representative. <sup>1</sup>
724 SHUTL INV PARM*	No	Shuttle Invalid Parameter. Firmware error on controller board.	Contact your authorized service representative. <sup>1</sup>

**Table 24 LCD Message Troubleshooting Table (H-Series)**

<b>Displayed Message</b>	<b>Can User Correct?</b>	<b>Explanation</b>	<b>Solution</b>
725:SHUTL OVER SPEED*	No	The shuttle is oscillating too rapidly.	Contact your authorized service representative. <sup>1</sup>
727:SOFTWARE ERROR*	No	Application software tried to perform illegal printer function, or damaged logic circuits found on controller board.	Contact your authorized service representative. <sup>1</sup>
730:TCB CORRUPTED*	No	Task Control Block Corrupted. Firmware error on controller board.	Contact your authorized service representative. <sup>1</sup>
733 DP FIFO Busy*	Yes	There is a timing problem in the Engine Controller firmware.	<ol style="list-style-type: none"> <li>1. Cycle power. Run the print job again. If the message reappears, download the emulation software again.</li> <li>2. Cycle power. Run the print job again. If the message reappears, contact your authorized service representative.<sup>1</sup></li> </ol>
B12 ERROR: PROGRAM MISSING*	Yes	The printer does not see a program in flash memory.	There is no program in printer memory. Download printer firmware again.
B13 ERROR: NOT COMPATIBLE*	No	Attempting to download a program that is not compatible with the printer.	Cycle power to see if the message clears, if not, contact your authorized service representative. <sup>1</sup>
B20 STATUS :00% DOWNLOAD MODE	No	Status message informing the operator that software is being downloaded. Percentage figure indicates approximate amount loaded into the printer.	No action is required.
B21 STATUS: PRINTER RESET	No	Status message informing the operator that the printer is undergoing a system reset.	No action is required.
B22 ERROR: DECOMPRESS SIZE*	No	FLASH memory has not passed boot initialization tests.	Cycle power to see if the message clears, if not, contact your authorized service representative. <sup>1</sup>
B23 ERROR: DECOMPRESS CKSUM*	No	FLASH memory has not passed boot initialization tests.	Cycle power to see if the message clears, if not, contact your authorized service representative. <sup>1</sup>



**Table 24 LCD Message Troubleshooting Table (H-Series)**

<b>Displayed Message</b>	<b>Can User Correct?</b>	<b>Explanation</b>	<b>Solution</b>
B30 STATUS: INITIALIZING...	N/A	Status message: the printer is running its initialization routines after startup and successful memory tests.	No action is required.
B50 STATUS: PANEL CODE BAD	No	Saved version of Panel Code is corrupt.	Reload released Firmware.
B51 STATUS: XX% LOADING...	No	Status message: printer boot-up routines are loading printer system software into flash memory and SDRAM.	No action required.
BAD NVM CALL 1 BAD NVM CALL 2 BAD NVM CALL 3 BAD NVM CALL 4 BAD NVM CALL A	Yes	Printer firmware code error with the Novram module that stores configurations and statistics.	<ol style="list-style-type: none"> <li>1. Cycle power. Run the print job again. If the message appears, load the latest emulation software.</li> <li>2. Cycle power. Run the print job again. If the message appears again, record the exact display message and follow the instructions on page 252, Diagnostics for EXX, BAD NVM, or ILL NVM Errors, and contact your authorized service representative.<sup>1</sup></li> </ol>
Bxx ERROR: NO DOWNLOADER FOUND	No	No Downloader was found while downloading a file.	Reload released Firmware.
CATASTROPHIC ERROR	No	Fatal error in printer.	Contact your authorized customer service representative. <sup>1</sup>
CLEARING PROGRAM FROM FLASH	No	Status message: emulation software successfully loaded into printer RAM and the checksum matched. The old program is now being deleted from flash memory.	No action is required.
D50 Status UPGRADING PANEL	No	Status message: The printer is upgrading the panel, where %XX represents the percentage completed.	No action is required.
D51 Status %XX Programming...	No	Status message: The printer is loading firmware, where %XX represents the percentage completed.	No action is required.

**Table 24 LCD Message Troubleshooting Table (H-Series)**

<b>Displayed Message</b>	<b>Can User Correct?</b>	<b>Explanation</b>	<b>Solution</b>
DIAGNOSTIC PASSED	No	Status message: the printer passed its memory and hardware initialization tests.	No action is required.
DO NOT POWER OFF	No	Status message: The printer is performing an operation that must be completed before you can cycle power.	No action is required, but do not power off the printer until the operation is complete.

**Table 24 LCD Message Troubleshooting Table (H-Series)**

Displayed Message	Can User Correct?	Explanation	Solution
E00 EXE @ ADDR0 E01A TYPE 0x40 E01B TYPE 0x60 E02 MACHINE CHK E03A DSI HASH L E03B DSI HASH S E03C DSI BAT PL E03D DSI BAT PS E03E DSI CXIWX E03F DSI CXOWX E03G DSI ECXIWX E03H DSI ECXOWX E04A ISI NO TRA E04B ISI DIRECT E04C ISI PROTEC E06 NOT ALIGNED E07 ILLEGAL INS E08 FLOATINGPNT E12 SYSTEM CALL E13 TRACE INT E16 ITRANS MISS E17 DLOAD MISS E18 DSTORE MISS E19 BREAKPOINT E20 SYS MANAGE E30 DEBUGGER E31A EVENT 0 BP E31B EVENT 1 BP E31C EVENT 2 BP E31D EVENT 3 BP E31E EVENT 4 BP E31F EVENT 5 BP E31G EVENT 6 BP E31H EVENT 7 BP E32A CND 0 BP E32B CND 1 BP E32C CND 2 BP E32D CND 3 BP E32E CND 4 BP E32F CND 5 BP E32G CND 6 BP E32H CND 7 BP E33 WRITE BP E34 TRACE CMPLT E99 UNKNOWN INT  See User Manual	Yes	An illegal or unsupported instruction was attempted in the application program.	1. Cycle power. Run the print job again. If the message appears, load the latest emulation software.  2. Cycle power. Run the print job again. If the message appears again, record the exact display message, follow the instructions on page 252, Diagnostics for EXX, BAD NVM, or ILL NVM Errors, and contact your authorized service representative. <sup>1</sup>  3. Power off the printer. Provide this fault message and the messages you recorded from the exception menu to your next higher support facility.
E-Net Test Unavailable	Yes	The ethernet PCBA did not initialize correctly.	Cycle power. Wait for "E-Net Ready" to display, then retry operation. If it still fails, contact your authorized service representative. <sup>1</sup>



**Table 24 LCD Message Troubleshooting Table (H-Series)**

<b>Displayed Message</b>	<b>Can User Correct?</b>	<b>Explanation</b>	<b>Solution</b>
ETHERNET INITIALIZING	No	Status message: the internal Network Interface Card is processing the boot procedure. (May occur with older versions of microcode.)	No action is required.
EXCEPTION ERROR	No	An EXCEPTION INTERRUPT has occurred.	Contact your authorized service representative. <sup>1</sup>
FLASH: CHECK RETURN	No	Printer encountered an error while trying to program Flash memory.	Contact your authorized service representative. <sup>1</sup>
FLASH: WAS NOT CLEARED	No	Printer encountered an error while trying to program Flash memory.	Contact your authorized service representative. <sup>1</sup>
FLASH: WRITE ERROR # 2	No	Printer encountered an error while trying to program Flash memory.	Contact your authorized service representative. <sup>1</sup>
GENERATING XX% NAND FLASH TABLE	No	NAND FLASH is being read and system tables are being initialized.	No action is required.
H00: PCI SLOT ? See User Manual	No	The controller board is not communicating with a PCI card. This could indicate a bad PCI card, poor connection, or problem in the PCI bus.	Contact your authorized service representative. <sup>1</sup>
H01: PCI J12 See User Manual	No	The controller board is not communicating with the PCI card in PCI slot J12. This could indicate a bad PCI card, poor connection, or problem in the PCI bus.	Contact your authorized service representative. <sup>1</sup>
<Online, etc...> Half Speed Mode	No	Status message: The controller samples the operating temperature of key components of the print mechanism. When higher than normal temperatures are sensed, the print speed is automatically reduced by 50% and the message sent the LCD. When the components cool down, the print speed returns to 100% and the message clears.	No action is required. If the message appears often, contact your authorized service representative. <sup>1</sup>

**Table 24 LCD Message Troubleshooting Table (H-Series)**

<b>Displayed Message</b>	<b>Can User Correct?</b>	<b>Explanation</b>	<b>Solution</b>
ILL NVM VALUE 5 ILL NVM VALUE 6 ILL NVM VALUE 7	Yes	Illegal value was stored into the Novram module.	<ol style="list-style-type: none"> <li>1. Cycle power. Run the print job again. If the message appears, load the latest emulation software.</li> <li>2. Cycle power. Run the print job again. If the message appears again, record the exact display message, follow the instructions on page 252, Diagnostics for EXX, BAD NVM, or ILL NVM Errors, and contact your authorized service representative.<sup>1</sup></li> </ol>
INITIALIZING...	Yes	This message indicates the printer is beginning its initialization process.	No action is required.
INTAKE FAN CHECK	Yes	Sensors cannot detect current in fan circuit.	Cycle power. If the message appears, press <b>CLEAR</b> . If the message does not clear, contact your authorized service representative. <sup>1</sup>
INTERRUPT UNUSED VECTOR 00	No	The controller board receives an interrupt it does not understand. The problem can be created by electrical noise, by a software problem, or by a hardware problem.	Cycle power. If this message occurred once and never again, you can ignore it. If the message reappears or appears consistently, contact your authorized service representative. <sup>1</sup>
LOADING PROGRAM FROM PORT XX%	No	Status message: the new emulation program is loading into printer RAM. XX% indicates how much of the program has loaded.	No action is required.
LOADING PROGRAM INTO FLASH	No	The printer has deleted the previous program from flash memory and is loading the new program into flash memory.	No action is required.
NEW SPX DETECTED PRESS ENTER	No	The printer detects an SPX installed at the debug port and the SPX is valid for the printer.	Contact your authorized service representative. <sup>1</sup>

**Table 24 LCD Message Troubleshooting Table (H-Series)**

<b>Displayed Message</b>	<b>Can User Correct?</b>	<b>Explanation</b>	<b>Solution</b>
NON VOLATILE MEMORY FAILED	No	Large emulations reduce the amount of space available for saving configurations, which means that sometimes fewer than eight configurations can be saved.	Contact your authorized service representative. <sup>1</sup>
ONLINE	N/A	Printer state message: printer is online and in communication with host.	No action is required.
PANEL BAD CHECKSUM	No	Panel Code has a bad Checksum.	Reload released firmware.
PARAMETER ERROR*	No	Illegal parameter value received in command code over a TN emulation.	Contact your authorized service representative. <sup>1</sup>
PLAT DRVR CIR	No	Platen driver circuit malfunction.	Contact your authorized service representative. <sup>1</sup>
PLEASE WAIT... RESET IN PROGRESS	N/A	Status message: the printer finished loading the program into flash memory and is automatically resetting itself.	No action is required.
PRINTER UNDER REMOTE CONTROL	No	Status message: The printer is under the control of PrintNet Enterprise (PNE) remote management software.	No action is required.
PROCESSOR HALTED EC_FAULT_RTSYS2	No	Real-time System Firmware error on controller board.	Contact your authorized service representative. <sup>1</sup>
REMOVE USED SPX THEN PRESS ENTER	No	Status message: An SPX is depleted because it has successfully reprogrammed the security key on the controller board.	Contact your authorized service representative. <sup>1</sup>
RESTORING BOOT CODE	No	Normal download initialization message.	No action is required.
SCS COMMAND ERROR*	No	In the TN emulation, the printer received undefined control character (hex 40).	Contact your system administrator.

**Table 24 LCD Message Troubleshooting Table (H-Series)**

<b>Displayed Message</b>	<b>Can User Correct?</b>	<b>Explanation</b>	<b>Solution</b>
SD CARD ERROR Remove SD Card	Yes	The printer has been powered up with a card in the SD slot, but the card is not functioning properly. The card could be a compact flash card or a non-supported card.	Power down, reseal card, and power up again. If error persists, power down, remove card, and try another card.
SDSC CARD NOT SUPPORTED Remove SD Card	Yes	The printer has been powered up with an SDSC card, and SDSC cards (< 4 GB) are not supported.	Power down, remove SD card, and insert an SDHC card in the printer.
SECURITY VIOLATION*	No	Security code of PAL on controller board does not match code of firmware on the controller board.	Contact your authorized service representative. <sup>1</sup>
SECURITY KEY NOT DETECTED	No	The security key is not present or has failed.	Contact your authorized service representative. <sup>1</sup>
SF ERROR	No	Structured Field Error. Application software has violated structured data field parameters.	Not a printer problem. Have the system administrator correct applications data or configuration.
SHUTTLE STALL	Yes	The shuttle is not moving.	Set the platen lever to match the thickness of paper, but not too tightly. Check and adjust the platen gap. Inspect the ribbon mask for deformation that snags and interferes with shuttle movement. If fault source is not apparent, contact your authorized service representative. <sup>1</sup>
SPX FOUND, ERROR: KEY NOT DETECTED	No	The controller board does not have a security key.	Contact your authorized service representative. <sup>1</sup>
SPX NOT NEEDED OPTIONS ENABLED	No	The user has attempted to use the SPX to turn on printer options that are already enabled.	Contact your authorized service representative. <sup>1</sup>
SYS R/T ERROR	No	Software issue.	Contact your authorized service representative. <sup>1</sup>
TCP PORT BUSY	Yes	Error message reported by the Printer Manager when ethernet interface option is installed. The network address given in the printer properties was reached, but the printer port is busy.	Refer to the <i>Printronix P8000 Maintenance Manual</i> .



**Table 24 LCD Message Troubleshooting Table (H-Series)**

<b>Displayed Message</b>	<b>Can User Correct?</b>	<b>Explanation</b>	<b>Solution</b>
<p><sup>1</sup> Before contacting an authorized service representative, power off the printer, wait 15 seconds, then power it back on and rerun your print job. If the message reappears, press CLEAR. If the fault message still displays, then contact your authorized service representative.</p>			



# A *Printer Specifications*

## Ribbon Cartridge Specifications

### ASCII

P/N	Europe, Middle East, & Africa	North America, Latin America (excludes Brazil), Canada	Asia Pacific (excludes China and India)	India and Brazil
Extended Life, 1 Pack	-101	-102	-103	-104
Extended Life, 4 Pack	-401	-402	-403	-104
Standard Life, 1 Pack	-101	-102	-103	-104

### HD and H-Series

P/N	Europe, Middle East, & Africa	North America, Latin America (excludes Brazil), Canada	Asia Pacific (excludes China and India)	India and Brazil
Extended Life, 1 Pack	-101	-102	-103	-104
Extended Life, 4 Pack	-401	-402	-403	-404
Standard Life, 1 Pack	N/A	N/A	-103	-104
Standard Life, 4 Pack			-403	-404

## Paper Specifications

Type: Edge-perforated, fan-fold, 3 to 17 inches (7.62 to 43.18 cm) wide, 2 to 12 inches (5.08 to 30.48 cm) long.

Thickness: Single-part: 15 to 100 pound (56 to 163 g/m<sup>2</sup>) stock;  
Multi-part: 1- to 6-part forms

Sheet Thickness: 0.025 inch (0.064 cm) maximum

Drive: Adjustable tractors (6-pin engagement)

## Labels

**On Backing:** One-part continuous perforated fanfold back form. Labels must be placed at least 1/6 inch (0.42 cm) from the fan-fold perforation. Backing adhesive must not be squeezed out during printing.

**Sheet Size:** 3 to 17 inches (7.62 to 43.18 cm) wide, including the two standard perforated tractor feed strips. A maximum sheet length of 16 inches (40.64 cm) between top and bottom perforations.

**NOTE:** A 16 inch rear door is needed for the cabinet model.

**Thickness:** Not to exceed 0.025 inch (0.064 cm) (including backing sheet)

## Printer Weight and Dimensions

Cabinet Type	Dimensions			Weight	
	Height (inches)	Width (inches)	Depth (inches)	Unpacked (pounds)	Packaged (pounds)
Cabinet	42.5	27	29	200	260
Open Pedestal	35	24.5	27	115	153

## Environmental Characteristics

### Temperature:

**Operating:** 50° to 104° F (10° to 40° C) up to 5000 feet (1524 meters)  
50° to 90° F (10° to 32° C) up to 6560 feet (2000 meters)

**Storage:** -40° to 158° F (-40° to 70° C)

### Relative Humidity

**Operating:** 15% to 80% (noncondensing)

**Storage:** 15% to 90% (noncondensing)

## Acoustic Noise Level

**Table 25 Acoustic Noise Levels per ISO 9296**

Printer Models	Printing	Standby
Cabinet	50 dB (ASCII 500 lpm/1000 lpm) 52 dB (300 lpm, 1500 lpm) 55 dB (600 lpm, 800 lpm, 2000 lpm)	48 dB
Pedestal	62 dB (300 lpm, 500 lpm) 65 dB (600 lpm, 1000 lpm)	50 dB
Zero Tear	66 dB (300 lpm, 500 lpm) 70 dB (600 lpm, 1000 lpm)	50 dB

# Electrical Characteristics

## Input Voltage (ASCII Models)

Printer Type	Configuration	Voltage (+/-10%)	Freq (+/-10%)	Amps (Max)	Watts (Typical)	BTU/Hr (Typical)
Cabinet	P8205	AC 100-240V	50/60 Hz	5A	320W	1093
Cabinet	P8210	AC 100-240V	50/60 Hz	5A	320W	1093
Cabinet	P8215	AC 100-240V	50/60 Hz	9A	475W	1622
Cabinet	P8220	AC 100-240V	50/60 Hz	9A	475W	1622
Pedestal	P8005	AC 100-240V	50/60 Hz	5A	320W	1093
Pedestal	P8010	AC 100-240V	50/60 Hz	5A	320W	1093
Zero Tear Pedestal	P8005ZT	AC 100-240V	50/60 Hz	5A	320W	1093
Zero Tear Pedestal	P8010ZT	AC 100-240V	50/60 Hz	5A	320W	1093

The above values are calculated while printing 136 column, all upper case high speed "E's". The stand-by (Energy Saver mode) wattage is 5W (17 BTU/Hr) for all models.

## Input Voltage (H-Series Models)

Printer Type	Model	Voltage (+/-10%)	Freq (+/-10%)	Amps (Max)	Watts (Typical)	BTU/Hr (Typical)
Cabinet	P8203H	AC 100-240V	50/60 Hz	5A	320W	1622
Cabinet	P8206H	AC 100-240V	50/60 Hz	9A	475W	1622
Cabinet	P8208H	AC 100-240V	50/60 Hz	9A	475W	1622
Cabinet	P8200HD	AC 100-240V	50/60 Hz	9A	475W	1622
Pedestal	P8003H	AC 100-240V	50/60 Hz	5A	320W	2053
Pedestal	P8006H	AC 100-240V	50/60 Hz	9A	475W	2053
Zero Tear Pedestal	P8003HZT	AC 100-240V	50/60 Hz	5A	320W	1622
Zero Tear Pedestal	P8006HZT	AC 100-240V	50/60 Hz	9A	475W	1622
Zero Tear Pedestal	P8000HDZT	AC 100-240V	50/60 Hz	9A	475W	1622

## Interfaces

Type:	Standard:	USB 2.0 Universal Serial Bus RS-232 serial
	Optional:	IEEE 1284 Parallel Centronics Parallel Ethernet 10/100Base-T
Logic Levels:		TTL/EIA <sup>®</sup> -232E/EIA-422B
Transfer Rates:		Up to 200 Kilobytes on parallel interface. Up to 115.2K baud on RS-232 serial interface.

## Printing Speed

The printing speed of text is measured in lines per minute (lpm) and is a function of the selected font and the vertical dot density. Printing speed is independent of the number of characters configured in the character set repertoire. Print rates for lines containing attributes such as bold or emphasized printing, superscripts, subscripts, or elongated attributes will decrease to not less than half the rates of the font without such attributes. The exact print rate of lines containing these attributes depends on the specific print job, but software maximizes the throughput by dynamically determining which dot rows contain adjacent dots and must be printed in two strokes.

The reverse paper feed capability allows the printing of multiple densities on a single line. This is useful in printing forms and text together or in mixing different fonts on a print line. Use of multiple densities and reverse paper feed also affects throughput.

# B Standard ASCII Character Set

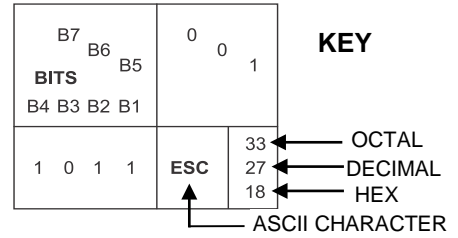

BITS B7 B6 B5 B4 B3 B2 B1	ROW	COLUMN							
		0	1	2	3	4	5	6	7
0 0 0 0	0	NUL 0 0 0	DLE 20 16 10	SP 40 32 20	0 60 48 30	@ 100 64 40	P 120 80 50	\ 140 96 60	p 160 112 70
0 0 0 1	1	SOH 1 1 1	DC1 (XON) 21 17 11	! 41 33 21	1 61 49 31	A 101 65 41	Q 121 81 51	a 141 97 61	q 161 113 71
0 0 1 0	2	STX 2 2 2	DC2 22 18 12	" 42 34 22	2 62 50 32	B 102 66 42	R 122 82 52	b 142 98 62	r 162 114 72
0 0 1 1	3	ETX 3 3 3	DC3 (XOFF) 23 19 13	# 43 35 23	3 63 51 33	C 103 67 43	S 123 83 53	c 143 99 63	s 163 115 73
0 1 0 0	4	EOT 4 4 4	DC4 24 20 14	\$ 44 36 24	4 64 52 34	D 104 68 44	T 124 84 54	d 144 100 64	t 164 116 74
0 1 0 1	5	ENQ 5 5 5	NAK 25 21 15	% 45 37 25	5 65 53 35	E 105 69 45	U 125 85 55	e 145 101 65	u 165 117 75
0 1 1 0	6	ACK 6 6 6	SYN 26 22 16	& 46 38 26	6 66 54 36	F 106 70 46	V 126 86 56	f 146 102 66	v 166 118 76
0 1 1 1	7	BEL 7 7 7	ETB 27 23 17	' 47 39 27	7 67 55 37	G 107 71 47	W 127 87 57	g 147 103 67	w 167 119 77
1 0 0 0	8	BS 10 8 8	CAN 30 24 18	( 50 40 28	8 70 56 38	H 110 72 48	X 130 88 58	h 150 104 68	x 170 120 78
1 0 0 1	9	HT 11 9 9	EM 31 25 19	) 51 41 29	9 71 57 39	I 111 73 49	Y 131 89 59	i 151 105 69	y 171 121 79
1 0 1 0	10	LF 12 10 0A	SUB 32 26 1A	* 52 42 2A	: 72 58 3A	J 112 74 4A	Z 132 90 5A	j 152 106 6A	z 172 122 7A
1 0 1 1	11	VT 13 11 0B	ESC 33 27 1B	+ 53 43 2B	; 73 59 3B	K 113 75 4B	[ 133 91 5B	k 153 107 6B	{ 173 123 7B
1 1 0 0	12	FF 14 12 0C	FS 34 28 1C	, 54 44 2C	< 74 60 3C	L 114 76 4C	\ 134 92 5C	l 154 108 6C	 174 124 7C
1 1 0 1	13	CR 15 13 0D	GS 35 29 1D	- 55 45 2D	= 75 61 3D	M 115 77 4D	] 135 93 5D	m 155 109 6D	} 175 125 7D
1 1 1 0	14	SO 16 14 0E	RS 36 30 1E	. 56 46 2E	> 76 62 3E	N 116 78 4E	^ 136 94 5E	n 156 110 6E	~ 176 126 7E
1 1 1 1	15	SI 17 15 0F	US 37 31 1F	/ 57 47 2F	? 77 63 3F	O 117 79 4F	_ 137 95 5F	o 157 111 6F	DEL 177 127 7F





# C *Zero Tear Pedestal Printer*

## **Overview**

The P8000 Zero Tear Pedestal (ZTP) printer can print a form and present it for tear off without losing a form between print jobs. The printer automatically presents the current print line to the tear bar when it finishes printing and no data are being sent to the printer. When it receives more data from the host computer, the printer pulls the form down to the print station and resumes printing.

The ZTP printer is available as follows:

- ASCII – 500 and 1000 line per minute models
- H-Series – 300 and 600 line per minute models
- OpenPrint HD models.

# Operation

## Position the Paper Input and Adjust the Paper Guides

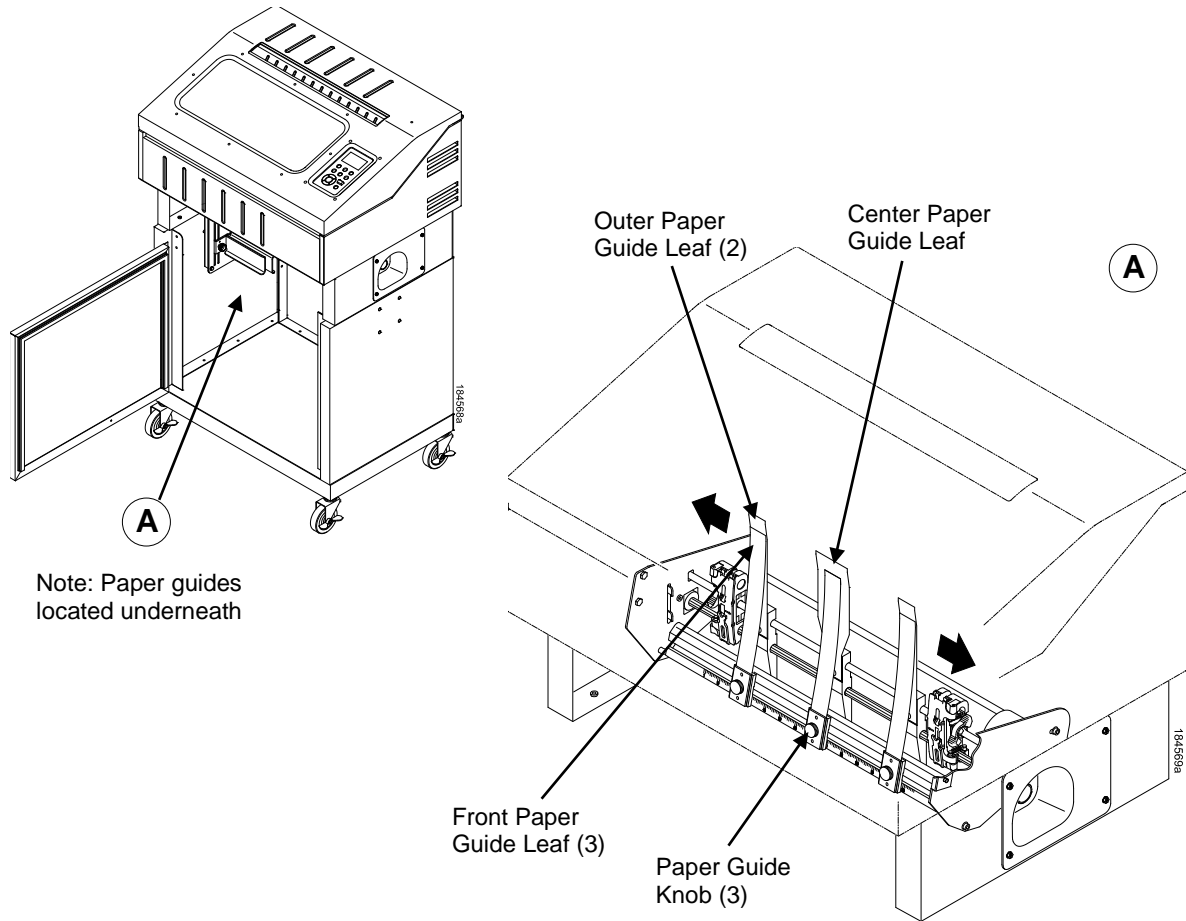

**Figure 45 Adjusting the Paper Guides**

**NOTE:** This operation is typically done during initial setup. Before beginning the procedure, ensure that the paper guides are not damaged.

1. Remove the left paper guide knob and the left, front paper guide leaf. (See Figure 45.)
2. Remove the right paper guide knob and the right, front paper guide leaf.
3. Remove the center paper guide knob and the center, front paper guide leaf.

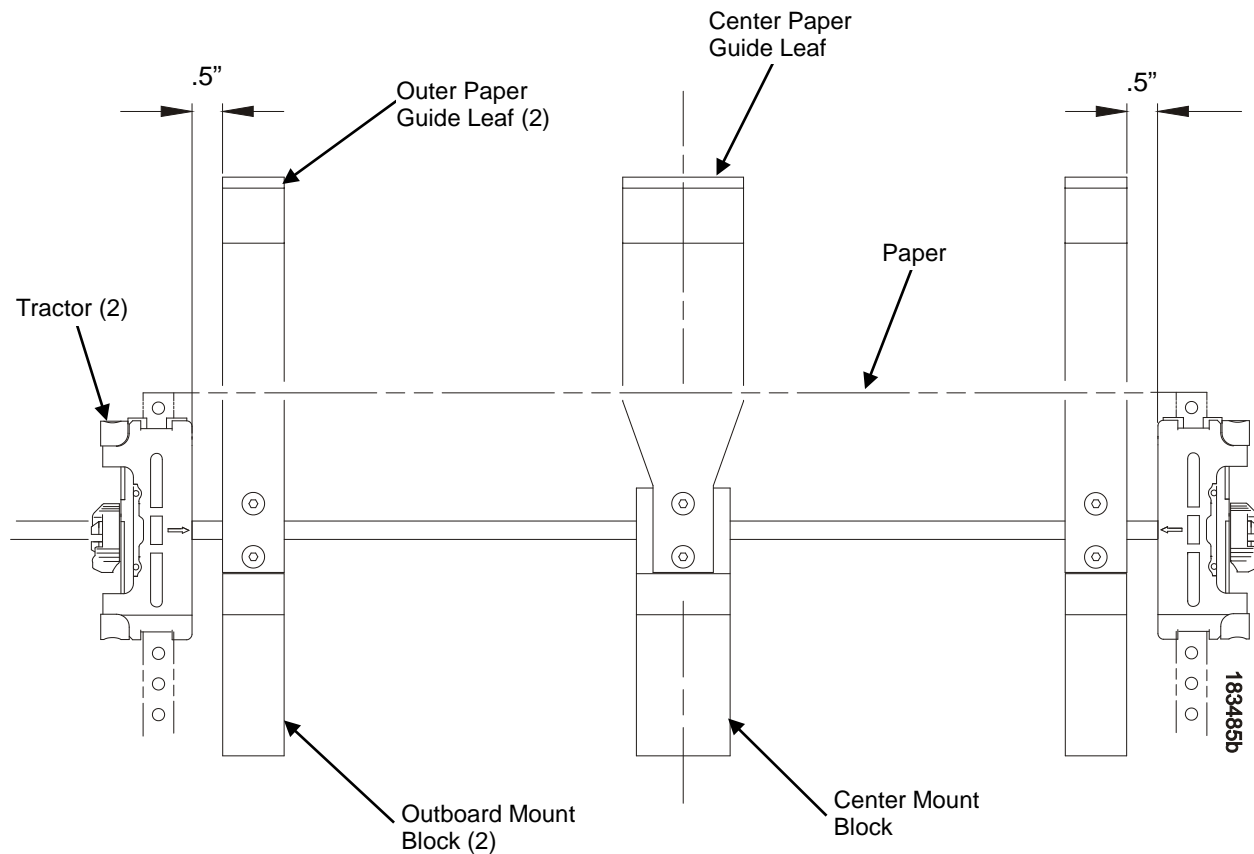

**Figure 46 Adjusting Paper Guide Leaves**

4. Slide the left outboard mount block so that the left outer paper guide leaf is .5 inches from the left tractor. (See Figure 46).
5. Slide the right outboard mount block so that the right outer paper guide leaf is .5 inches from the right tractor.
6. Slide the center mount block so that the center paper guide leaf is centered between the left and right outer paper guide leaves.
7. Install the paper guide knobs and front paper guide leaves. (See Figure 45.)

## Load Paper

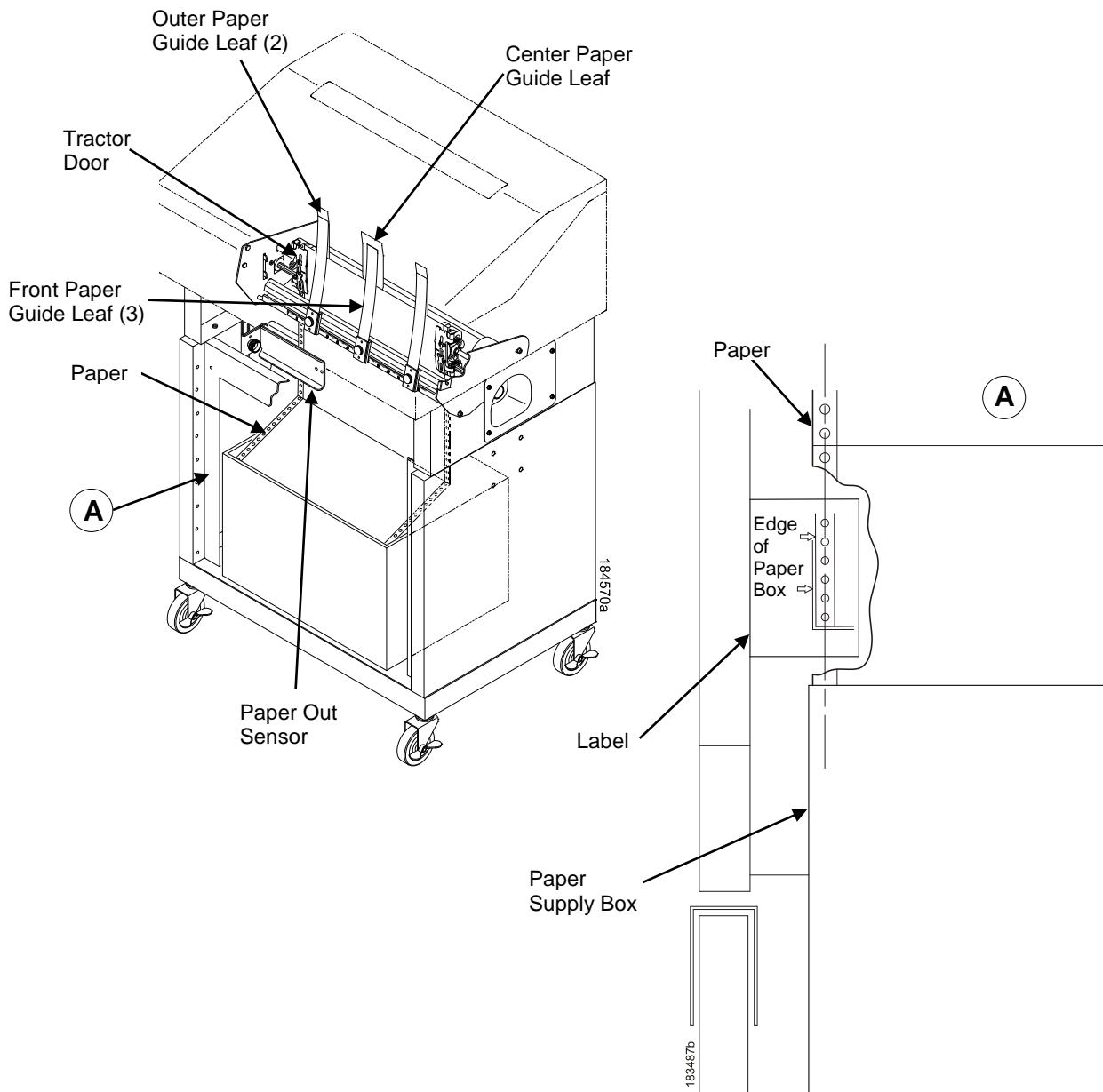

**Figure 47 Loading Paper onto the Printer**

1. Align the paper supply box with the label on the left side of the floor. (See Figure 47 on page 300.)
2. Unlock and open the tractor doors and slide the paper from below, through the black paper out sensor slot on the left side, and up between all front and rear paper guides.
3. Load the paper on the left tractor sprockets and close the tractor door.
4. Load the paper onto the right tractor sprockets and close the tractor door.

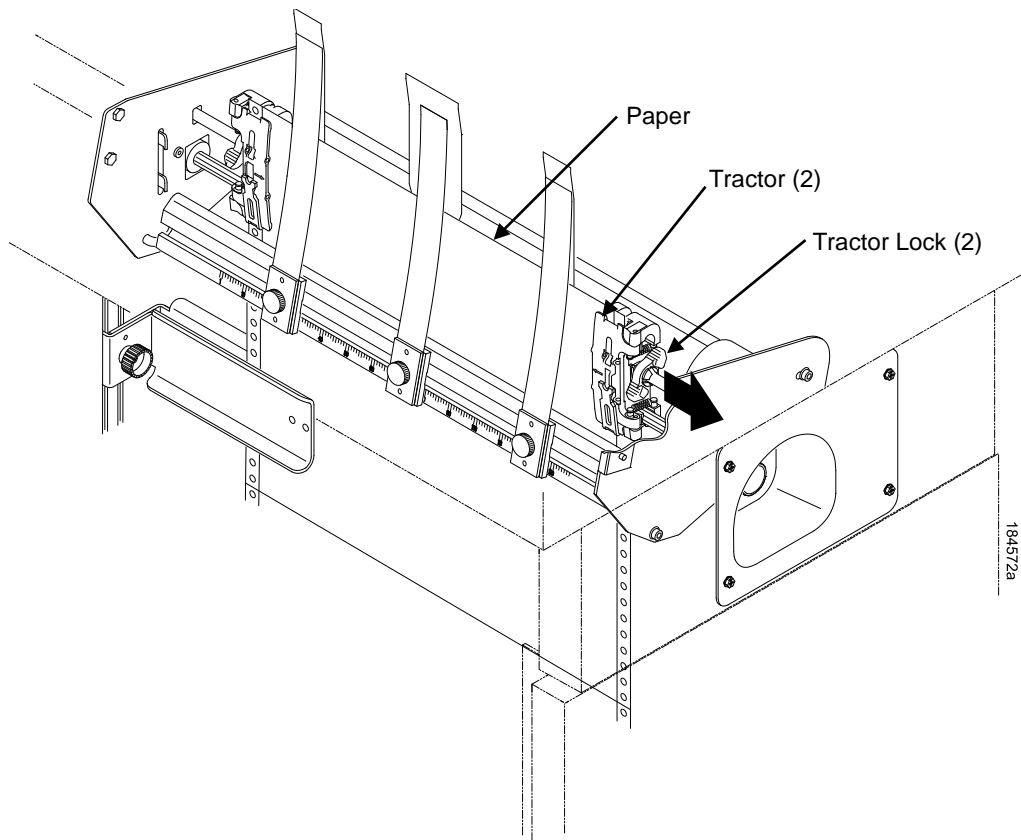

**Figure 48 Adjusting the Horizontal Paper Tension**

5. Adjust the paper web tightness by sliding the right tractor to remove slack or to adjust for various paper widths. (See Figure 48.)
6. Lock the tractors in position by pressing down on the tractor locks.

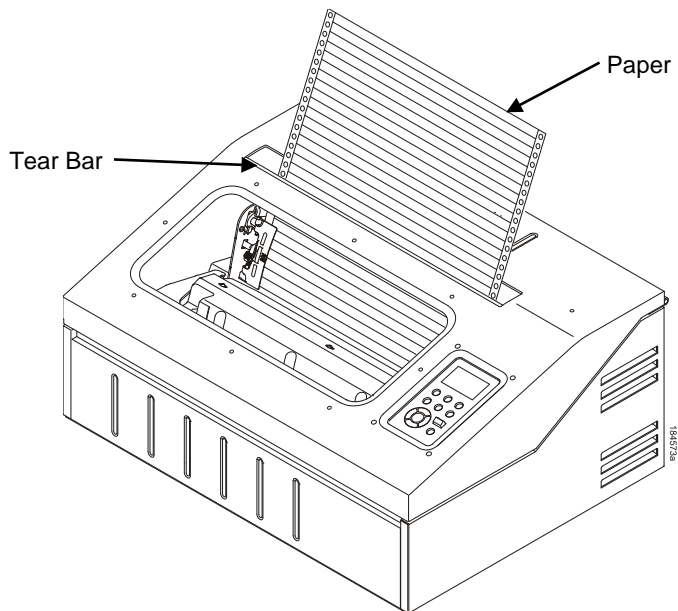

**Figure 49 Paper Exiting the Top of the Printer**

## Position the Paper Out Sensor

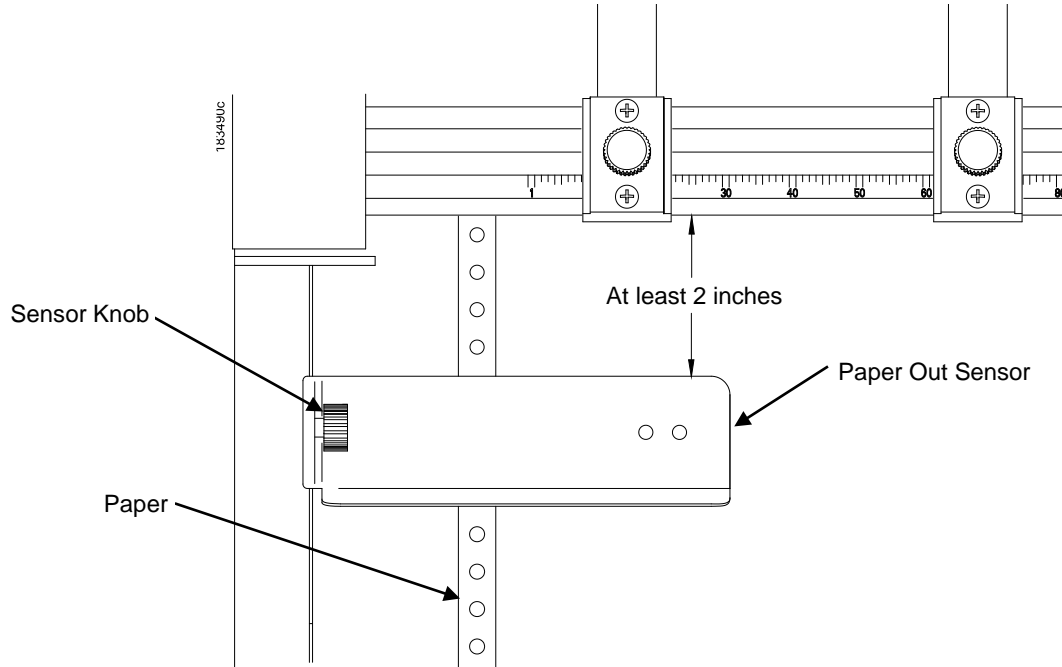

**Figure 50 The Paper Out Sensor**

The paper out sensor indicates when the printer runs out of paper. (The sensor does not work with black backed forms.) Unlike the standard pedestal printer, the ZT printer requires you to load the paper through the paper out sensor slot (Figure 47 and Figure 50). Correct positioning of the paper out sensor ensures that the last form the printer prints will be properly presented to the tear bar. To position the paper out sensor, do the following:

1. Position the paper properly at the tear bar (page 304).
2. Loosen the paper out sensor by turning the sensor knob counterclockwise.
3. Position the paper out sensor so that there are at least 2 inches between the bottom of the aluminum extrusion bar and the top of the paper out sensor.

**IMPORTANT** For optimal performance, 2 inches is recommended for 11 inch forms. For shorter forms, position the paper out sensor so that there are at least 2 inches between a perforation and the top of the paper out sensor.

4. Tighten the paper out sensor by turning the sensor knobs clockwise.
5. Press **ONLINE**. When the first print job is sent to the printer, the paper is drawn into the printer, the top of form aligns with the print station, and the print job begins.

## Set the Tear Bar Distance

To set the tear bar distance, do the following steps:

1. Make sure the printer is offline.
2. Press **ENTER** key to enter Menu mode.
3. Press the right arrow  $\triangleright$  until the PRINTER CONTROL icon is highlighted.
4. Press **ENTER** to go into PRINTER CONTROL.
5. Press the down arrow  $\nabla$  until "ZTP SETTINGS" is highlighted.
6. Press **ENTER** to go into the "ZTP SETTINGS" submenu.
7. Press the down arrow  $\nabla$  until "ZTP TearDistance" is highlighted.
8. Press the left arrow  $\triangleleft$  or right arrow  $\triangleright$  to decrease or increase the tear bar distance in increments of 1/144th of an inch.
9. Press **ENTER** to select the desired value. An asterisk appears next the selected value and a scale prints to indicate the tear bar distance in relation to the tear bar. For correct tear bar distance, the zero should align with the tear bar. See Figure 51.

**NOTE:** The Tear Distance value must be changed to print the scale.

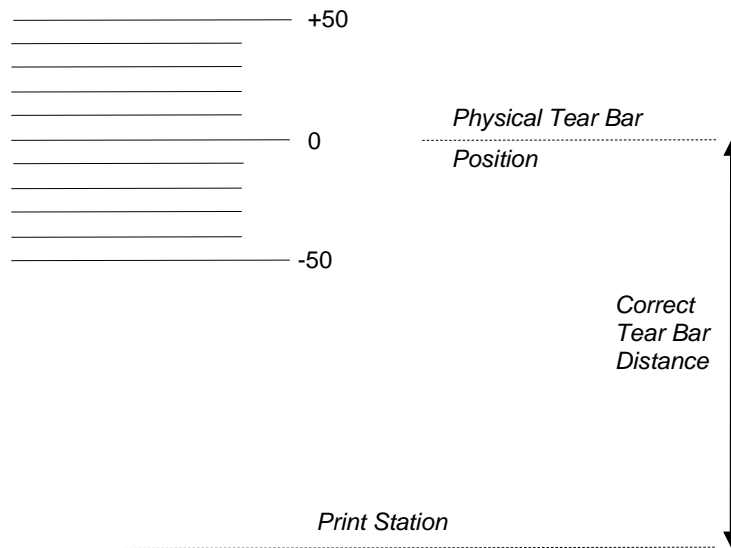
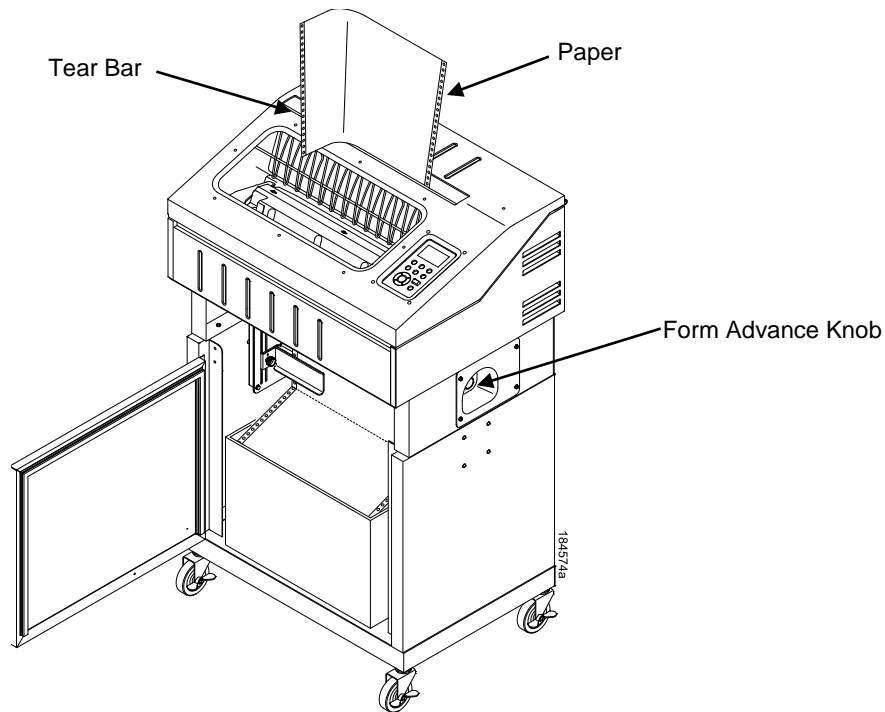

**Figure 51 Correct Tear Bar Distance**

**NOTE:** When a new ZTP Tear Bar Dist value is selected, the printer will lose the current print position until you reset the top of form to automatically save the new value.

10. Reset the top of form using the procedure on page 304.

## Set the Top of Form



**Figure 52 Setting The Tear Off Position**

The ZT printer uses the tear bar as the reference point for setting the tear off position. To set the position of the forms perforation to the tear bar, use the SET TOF button as follows:

1. Make sure the paper guides are adjusted correctly and the paper is properly loaded.
2. Press the **TOF** button on the control panel. The printer LCD will display "Align at TearBar/Then Press TOF".
3. Use the form advance knob to move the top of the form to the tear off bar.
4. Position the perforation so it aligns with the tear off bar.

**NOTE:** This is easily done by advancing one complete sheet above the tear off bar and folding it over at the perforation.

5. Position the fold exactly at the tear bar.
6. Tear the sheet off to ensure proper positioning.

**NOTE:** If you do not want to lose a form, position the top of the form at the tear bar. Run a finger along the back of the form along the tear bar to ensure the perforation is presented at the tear off point.

7. Press the **TOF** button again. The printer LCD will display "Top Of Form Set/Press ONLINE". The printer will then be brought OFFLINE and the top of form will be set.

**NOTE:** Unlike the non-ZTP models, the paper will not move.

8. Press the ONLINE key to bring the printer online.



# ZTP SETTINGS Menu

The ZTP SETTINGS menu includes the ability to enable and disable features unique to the Zero Tear printer (ZTP), set the tear bar distance, set the auto present data time, and set the auto present wait time. This section defines these options.

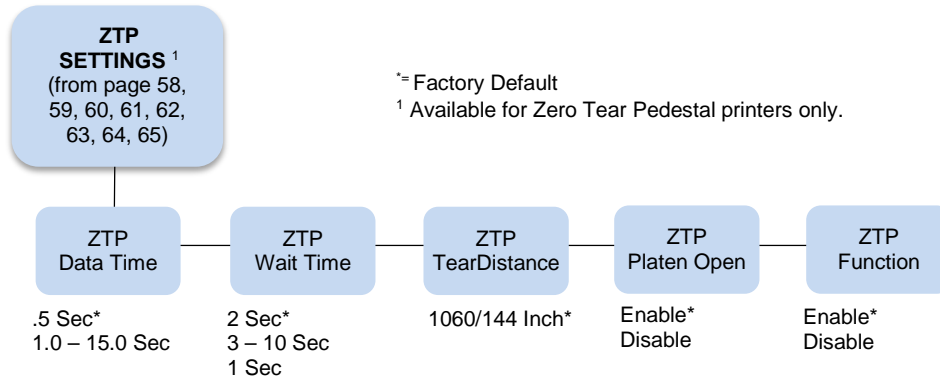

## ZTP Data Time

This option sets the pause time in the data stream that the ZTP requires before moving the form to the tear bar once a print job is completed. The values range from .5 to 15 seconds. The default is .5 seconds.

## ZTP Wait Time

This option sets the minimum amount of time that the form stays at the tear bar. This allows you time to remove the form before the form is retracted to print the next form. The adjustable values range from 1 to 10 seconds in increments of 1 second. The default value is 2 seconds.

## ZTP TearDistance

This option sets the tear off distance from the current print position to the tear bar. Adjustable values in increments of 1/144th of an inch range from 200 to 2880. The left and right arrows adjust the display value. When you press the **ENTER** key, the selected value is stored and a scale is printed to indicate the current tear off position. The default value is 1060.

**NOTE:** When a new value is selected, the printer will lose the current print position. You must reset the top of form to automatically save the new value.

## ZTP Platen Open

This option allows the user to have the platen open whenever forms are reversed. Enabled is the default, used for most papers and labels. The feature can be disabled as required by some multi-part forms.

## ZTP Function

This option enables or disables all unique ZTP functions. The default is Enable.

**NOTE:** When the ZTP Function is enabled, the VIEW key is disabled and Slow Paper Slew is enabled.

# Performance Limitations

## Forms Type

The paper feed tractors on the ZT printer push the paper up through the print station instead of pulling it through, as in the standard pedestal printer. This limits the variety of forms the ZT printer can use. If the forms do not fall within the range specified in Table 26, dot compression and line separation may occur. The user should match the media to the application to ensure acceptable print quality. Also, because paper is pushed from below the print station, the last form in the tractors may not print fully or may not be presented to the printer exit for retrieval.

All paper used in the ZT printer requires standard half inch spaced tractor feed holes. Cut sheet and continuous friction fed paper is not supported. The forms specified in Table 26 can have no more than one form per page horizontally.

**Table 26 Forms Type**

Description	Length	Width (edge to edge)
One to three part, continuous, with carbon, fan-folded, edge-perforated paper forms	3 to 12 inches	7 to 16.5 inches
One to four part, continuous, with carbon, fan-folded, edge-perforated paper forms	3 to 12 inches	7 to 12 inches
One to four part, continuous, carbonless, fan-folded, edge-perforated paper forms	3 to 12 inches	7 to 16.5 inches
One to six part, continuous, carbonless, fan-folded, edge-perforated paper forms	3 to 12 inches	7 to 12 inches
Forms with a paper weight of 20 to 100 pounds and a maximum thickness of 0.025 inches	3 to 12 inches	7 to 16.5 inches
Forms with a paper weight of 18 to 100 pounds and a maximum thickness of 0.025 inches	3 to 12 inches	7 to 12 inches
Forms with all approved types of interleaf edge attachment except those using metallic or other hard devices	3 to 12 inches	7 to 12 inches

**NOTE:** If you use forms outside these limits, the print quality may not be optimum, the printer may lose top-of-form, or the frequency of paper jams will increase.

## Paper Jams

Printer jams can occur if you tear off the form incorrectly. If you experience two or more paper jams per box of forms, follow these guidelines to help reduce jams:

- Position the lower paper guides properly
- Align the paper web tightness properly
- Position the form perforation against the tear bar
- Time the tear, while the paper is not moving
- Direct the tear force toward the user and across the tear bar, not upward.

**To Clear Paper Jams**

1. Raise the platen lever to open the platen.
2. Open the left and right tractor doors.
3. Pull the paper upward through the top of the printer.

**NOTE:** DO NOT pull the paper downwards from the bottom. This could cause the paper guides to bend.

4. Reload the paper (see page 300).



# D *Quick Change Memory Card (QCMC)*

## Overview

The QCMC provides the ability to duplicate an entire printer's firmware, saved configurations, and custom files quickly through the printer's control panel with a user friendly interface. No external host or files are needed to transfer this information to the QCMC. A "snapshot image" is saved of the printer's firmware, configuration settings, and custom files. The saved image can be copied to any number of printers using the same QCMC so that the printers will be identically configured (assumes same printer hardware and options are present).

The QCMC has its own resident network MAC address that will be used in place of the printer's LAN/WLAN MAC address when the cartridge is left installed in a printer. This allows a mission critical printer to be exchanged quickly with a spare printer that will be identically configured, including the network MAC address.

The following are examples of how the QCMC may make printer management more convenient:

- A site has 10 printers to install that should all be configured identically. Rather than inputting the information through the control panel individually to each printer, insert the QCMC into the first printer, capture the changes, then easily share the image with the other nine printers.
- A site is adding additional printers and wants them configured the same as the printers already installed, but is unsure what changes were originally made. By using the QCMC to capture the exact image of the older printers, no custom settings will be missed.
- A printer is set up on a network that is configured to only allow recognized MAC addresses to access the network. If the printer with the QCMC installed needs repair and must be removed from the network, the MAC that resides on the QCMC can be easily transferred to the replacement printer, along with all the configuration information and any other files stored as the "snapshot image" on the QCMC, making the replacement printer an exact duplicate for the downed printer. By using the MAC address that resides on the QCMC, the replacement printer can be installed without notifying the network administrator, thereby simplifying the exchange.

# Installing the QCMC

**CAUTION** You must power off the printer before you install or remove the QCMC, or you may damage the QCMC and the printer. If you remove the QCMC after powering on the printer with the QCMC installed, the fault message “SD REMOVED Reboot Printer” will display. You cannot clear this message by reinserting the QCMC. You must cycle power.

1. Set the printer power switch to O (Off).
2. Insert the SD card into the QCMC slot on the back of the printer.

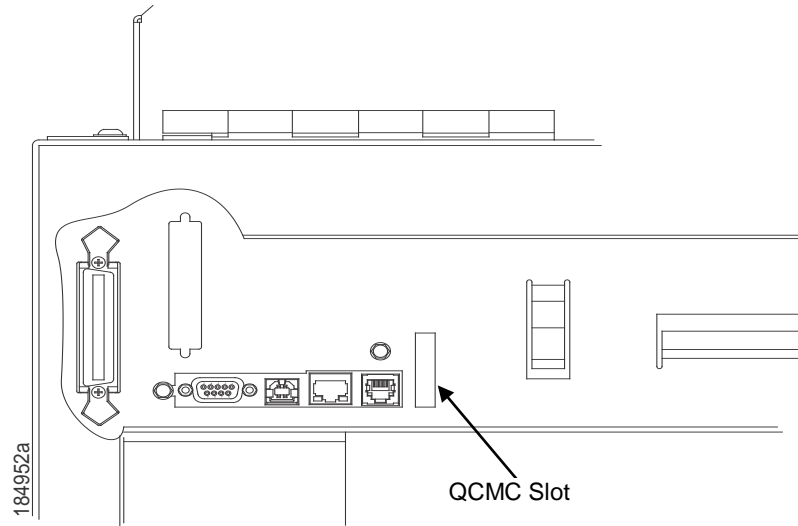

**Figure 53 QCMC Slot on Back of Cabinet Model**

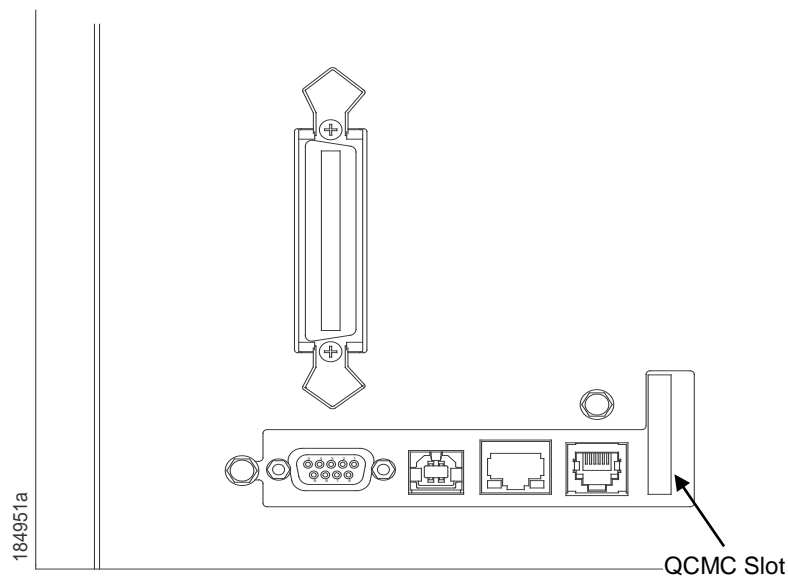

**Figure 54 QCMC Slot on Back of Pedestal**

# Saving the Printer's Configuration to the QCMC

**NOTE:** The MAC address residing on the QCMC will be used in place of the MAC assigned to the printer's own network card whenever the QCMC is installed. If you do not want to identify the printer with this MAC address, make sure the QCMC is removed from the printer before attaching the printer to the network.

When the printer software detects the presence of a QCMC at power-up, a check of the QCMC will be performed to determine if there is already a saved flash image available. If no printer flash image exists on the QCMC, the software will then check to see if there are any saved configurations in the printer's NVRAM memory. If the QCMC is blank (no flash image) and saved configurations are detected in the printer's NVRAM then you will be prompted with a message on the front panel to save the printer's configuration to the QCMC.

**QMC DETECTED**

**Save to QCMC?**

**Continue Press <ENTER>**

**Skip Press <CANCEL>**

**NOTE:** This screen will appear every time at power-up until the printer's flash is saved to the QCMC.

If the <CANCEL> key is pressed, the printer will reboot into normal operation and not save any information to the QCMC. On subsequent power-ups the Save message on page 311 will display again.

When the <ENTER> key is pressed, the printer will not go online, but instead will copy the printer's entire flash image to the QCMC, creating a snapshot of the printer's memory.

Below is a list of items that will be saved to the QCMC:

- Printer Program File (software)
- Custom configurations (1–8)
- Feature files or CST's that have been downloaded on the printer.
- All variable settings from the printer's NVRAM
- Network settings (if LAN/WLAN is installed), including IP Address
- Other user files, such as fonts, bitmaps, or graphics files downloaded to the printer.

While the printer is saving its QCMC settings to the SD card, the following message will display. Do not interrupt the process.

**DO NOT PWR OFF**

**Saving Setup**

**To QCMC...**

 **XX%**

Upon successful completion of saving a flash image to the QCMC, the printer will display a message indicating the operation is complete. The printer will then reboot into normal operation.

**Save Complete  
Printer Will Now  
Reboot...**

If there is not enough space on the SD to save the entire flash image, you will be prompted with the following message.

**NOT ENOUGH  
SPACE ON SD  
Delete SD File**

This is a fatal error and requires user intervention. Cycle power on the printer, when prompted to save the QCMC select <CANCEL> to skip. The printer will boot online and allow access to the SD file menus located under the Advanced User menu. Delete unnecessary SD files then try the QCMC Save operation again.

## **Copying the QCMC “Snapshot” Image to a Second Printer**

Always power off the printer before removing or inserting the QCMC. Place the QCMC into the second printer’s memory slot. Upon power up, the printer software detects the presence of a QCMC and a check of the QCMC will be performed to determine if there is already a saved flash image from this QCMC on the printer. If no, the following message will display:

**QCMC DETECTED  
Copy to Printer?  
Yes...Press <ENTER>  
No...Press <CANCEL>**

**NOTE:** This message will appear every time at power-up until the QCMC settings are copied to the printer.

If the <CANCEL> key is pressed, the printer will reboot into normal operation and not copy any information to the printer. On subsequent power-ups the Copy message above will display again if the QCMC remains installed in the printer.

**NOTE:** If the QCMC remains installed in the printer, the MAC address onboard will be used in place of the resident MAC address to the printer’s LAN/WAN interface card.

When the <ENTER> key is pressed, the printer will not go online immediately, but will copy the contents of the QCMC to the printer’s flash, creating a clone of the original printer. Before the copy process is allowed to continue, checks of the printer configuration will be made. If either of the checks



fail, a message will display on the front panel (in the hierarchy shown on page 312) and the printer will not copy any settings.

**INVALID SD**

**Power Off Printer**  
**Remove Cartridge**

This means that the QCMC is not compatible with the printer's software. A software upgrade is required, or a different configured QCMC will be needed.

A QCMC validation check will be performed to ensure the data stored on the SD is not corrupted. If the test fails the following fault message will display.

**QCMC DATA ERROR**  
**ON SD**

**Delete & Resave**  
**QCMC Data**

This means that the data on the QCMC was not saved properly, and must be deleted then resaved. Follow the instructions for deleting files, then repeat the copying process.

If all the checks pass, then the printer will copy the files from the QCMC to the target printer.

**DO NOT PWR OFF**  
**Copying QCMC To**  
**Printer...**

 **XX%**

Upon successful completion, the printer will display the following message on the front panel and reboot into normal operation.

**Copy Complete**

## Updating the QCMC Image

This option should only be used when a QCMC has already been stored and when that QCMC already contains the printer build and files on the printer. If only some configuration settings have been altered, the menu “Update QCMC” can be used to update the configuration settings in the image stored on the QCMC.

To utilize this option, navigate to the menu “Update QCMC” and press the ENTER key.

Below is a list of items that will be updated on the QCMC by the “Update QCMC” operation:

- Custom configurations (1–8)
- All variable settings from the printer’s NVRAM
- Network settings (if LAN/WLAN is installed), including IP Address

Below is a list of items that will NOT be updated on the QCMC by the “Update QCMC” operation:

- Printer Program File (software)
- Feature files or CST’s that have been downloaded on the printer.
- Other user files, such as fonts, bitmaps, or graphics files downloaded to the printer.

While the printer is updating the QCMC configuration, the following message will display. Do not interrupt the process.

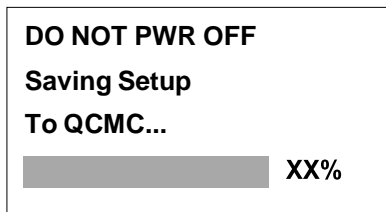

Upon successful completion of saving a flash image to the QCMC, the printer will display a message indicating the operation is complete. The printer will

## Erasing the QCMC Image

This option should only be used when a QCMC has already been stored and when the user desires to start fresh with a new image.

To utilize this option, navigate to the menu “Erase QCMC” and press the ENTER key.

When this option is activated, all QCMC files and configurations will be deleted from the SD card.

While the printer is erasing the QCMC configuration, the following message will display. Do not interrupt the process.

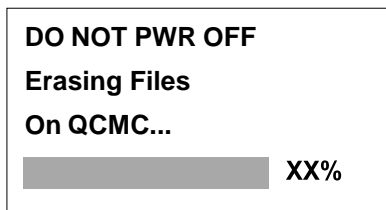

Upon successful completion of saving a flash image to the QCMC, the printer will display a message indicating the operation is complete. The printer will then reboot into normal operation.

# E *PTX\_SETUP* Commands

## Overview

The PTX\_SETUP commands are a superset of commands which allow the printer to perform several tasks by parsing commands either stored in flash or sent to the printer by the host. Commands range from re-routing debug statements to downloading complete printer configurations.

This appendix describes the PTX\_SETUP commands available to line matrix printers.

## The PTX\_SETUP Commands

The PTX\_SETUP commands were originally designed for the disk-based laser and thermal printers with IGP. However, line matrix printers can still benefit from general functionalities provided by the PTX\_SETUP commands.

Some concepts to keep in mind are as follows:

1. PTX\_SETUP commands are not emulation specific. In a system with an IGP, the IGP level emulation will process the PTX\_SETUP commands. In a system without an IGP, the PTX\_SETUP commands will be processed by the base emulation.
2. Since there is no disk on a flash-based printer, DISK\_IO commands are now called FILE\_IO. However, for backwards compatibility DISK\_IO and FILE\_IO are synonymous.
3. The PTX\_SETUP command set is case sensitive; all PTX\_SETUP commands are in upper case characters only.
4. The white space separating commands may be any number of spaces and tabs. This allows a PTX\_SETUP file to be formatted for easier readability.
5. The PTX\_SETUP and PTX\_END command should be followed by a new line character.
6. Any unknown command will terminate the PTX\_SETUP processing. The offending command will be the first line of printed text.
7. Although the original implementation of PTX\_SETUP allowed for only a single parameter, separated from the sub-command by a single semicolon (;) character, the new PTX\_SETUP command set allows for multiple parameters separated by commas, semicolons, spaces or tabs.

## General Commands

The original PTX\_SETUP commands were implemented on the disk-based legacy laser printers; however, many commands are general and are also supported on line matrix printers. This section describes the existing commands which work across all platforms, and provides a general description of how commands are formed.

Each emulation has modes in which the PTX\_SETUP commands could get missed. For this reason, it is highly recommended that all PTX\_SETUP commands be placed between print jobs, rather than attempting to imbed them within jobs.

PTX\_SETUP commands have the following format:

**(SFCC)PTX\_SETUP**

*Command–Sub Command;Value*

**PTX\_END**

For example, if the SFCC assigned to PTX\_SETUP is the default value of the exclamation mark (!, hex 21), and you wanted to load configuration number 4 and capture all incoming data to a file named “BIN”, you would use the following command:

```
!PTX_SETUP
CONFIG–LOAD;4 FILE_IO–CAPTURE;BIN
PTX_END
```

Table 27 lists all the command, sub-command, and parameter combinations and gives a brief description of the command. This section documents the existence of PTX\_SETUP commands which work across all platforms. The following sections document commands which are specific to line matrix.

**NOTE:** When a file system error occurs, a message will be displayed on the front panel indicating the error, and the action needed to take to correct the error.

**Table 27 PTX\_SETUP Commands (Non-Platform Specific)**

Command	Sub-Command	Parameter	Description
CONFIG	LOAD	<i>Cfg</i>	<i>Cfg</i> can be 0-8. The PTX_SETUP will load configuration <i>Cfg</i> . If configuration <i>Cfg</i> was not previously saved, the operator panel will display an error message and the current configuration will be kept.
	SAVE	<i>Cfg</i>	<i>Cfg</i> must be 1-8. This command will save the current configuration as configuration <i>Cfg</i> . If <i>Cfg</i> is not in the range of 1-8, the command is ignored.
	SETMENU	<i>Value;Menu_tag</i>	<i>Menu_tag</i> is the name of the menu as defined in the menu file. <i>Value</i> is the value to which the menu is to be set.
	POWERUP	<i>Cfg</i>	Sets the power-up configuration to <i>Cfg</i> and loads Configuration <i>Cfg</i> . <i>Cfg</i> can be any value from 0-8, where 0 is the factory default.
	PRINT	<i>Cfg</i>	Print Configuration <i>Cfg</i> . <i>Cfg</i> can be a number 1-8, or one of four pre-defined configurations. The four non-numeric configurations are requested using the first character for the CURRENT, FACTORY, POWERUP, or ALL configuration(s).

**Table 27 PTX\_SETUP Commands (Non-Platform Specific)**

Command	Sub-Command	Parameter	Description
CONFIG	DELETE	<i>Cfg</i>	Deletes Configuration number <i>Cfg</i> . <i>Cfg</i> must be in the range of 1-8.
	UPLOAD	<i>Port;Cfg</i>	This command uploads the configuration stored in location <i>Cfg</i> to the port specified by <i>Port</i> . <i>Port</i> must either be 1284 or SERIAL. <i>Cfg</i> may be 1-8 or ALL.
	DOWNLOAD	<i>Cfg</i>	This command saves the configuration data that follows as configuration <i>Cfg</i> . <i>Cfg</i> must be 1-8 or END.
	OVERLAY	<i>Cfg</i>	This command overlays the configuration data that follows on existing configuration <i>Cfg</i> . <i>Cfg</i> must be 1-8 (or END). If <i>Cfg</i> does not exist then command is treated the same as DOWNLOAD.
	RESET		Reboots the printer.
	GET_NAMES	<i>"Port"</i>	This command uploads the names of the configurations to the port specified by <i>Port</i> . <i>Port</i> must either be "1284" or "SERIAL".
	SET_NAME	<i>Cfg</i>	This command downloads a name for the configuration specified by <i>Cfg</i> . <i>Cfg</i> must be 1-8.
	CLEAR_NAMES		This command resets all of the configuration names to their default values.
	MPI_SELECT	<i>MPI</i>	This command selects the active Management Protocol Interface (MPI). Currently there are two selections "UCP" and "PXML".
PNE_PORT	<i>Port</i>	This command selects the port that the PNE will use to communicate to the printer. The valid ports are: <ul style="list-style-type: none"> <li>• DISABLE</li> <li>• ETHERNET</li> <li>• USB</li> </ul> <b>NOTE:</b> If ETHERNET is selected but not enabled, the selection will revert to DISABLE.	

**Table 27 PTX\_SETUP Commands (Non-Platform Specific)**

Command	Sub-Command	Parameter	Description
CONFIG	PANEL	LOCK	This command locks the operator out of the printer's configuration menu.
		UNLOCK	This command unlocks the printer's configuration menu and allows the operator access to the menus. By default, the menu is unlocked.
	PNE_PROT_NUM	Port Number	This command sets the Port Number the PNE uses to communicate to the printer if the PNE Port was set to Ethernet. This command causes the printer to automatically reboot.
	PXML_PORT_NUM	Port Number	This command sets the Port Number the PXML and UCP will use to communicate to the printer if the PXML Port is set to Ethernet. This command causes the printer to automatically reboot.
LP MODE	n/a	Protocol	<i>Protocol</i> must be 0-4. This command resets the software protocol, and is selected as follows: 0 - P-Series 1 - P-Series XQ 2 - Serial Matrix 3 - Proprinter III XL 4 - Epson FX-1050
FILE_IO (DISK_IO)	CAPTURE	Filename	Captures all incoming data into a file named <i>Filename</i> . Receipt of a FILE_IO-CAPTURE command without the <i>Filename</i> parameter will force the file data to be written to flash, and will end the file capture.
	DRIVE	Letter	This command is parsed for backwards compatibility. However, since the flash file system is a single device, the drive letter will be ignored.

**Table 27 PTX\_SETUP Commands (Non-Platform Specific)**

Command	Sub-Command	Parameter	Description
FILE_IO (DISK_IO)	PROPS	File;Prop	The PROPS command will set the file properties of a given file. The file properties are a four letter, case sensitive file descriptor. The properties field can be used to ensure that a file is used for its intended purpose. Once properties have been associated with a file, they cannot be changed.
	DEL	Filename	The DEL command will mark a file as deleted. The space the file occupied will be freed the next time the printer is powered up.
	RUNFILE	File;Prop	The RUNFILE command will open the file named <i>File</i> for printing. After the PTX_END command is processed, the contents of <i>File</i> will get printed before any more data is read from the host. If the <i>Prop</i> field is present, RUNFILE will verify that <i>Prop</i> matches the saved file properties. Any mismatch will cause the command to be ignored.
	UPLOAD	File;Port	Reads the file named <i>File</i> out of the flash file system and sends it to a host computer via the <i>Port</i> I/O port. <i>Port</i> is either 1284 (for reverse nibble or byte mode transfer using the parallel port), or SERIAL. NOTE: if the Ethernet option is installed, 1284 is used to upload across the network.
	MAXSIZE	Kb	For backwards compatibility.
	MINSIZE	Kb	For backwards compatibility.
	OPTIMIZE	(none)	Causes the printer to optimize the Flash File System. The printer automatically reboots during this process.
PTX_END	(none)	(none)	Exits the PTX_SETUP.

## Summary of the CONFIG Command

The UPLOAD and DOWNLOAD command can be used for uploading and downloading complete printer configurations. If a customer needs to configure 50 printers identically, the customer needs only configure one printer and UPLOAD the configurations. The UPLOADED configurations may then be DOWNLOADED to other printers eliminating the necessity for the operator to configure each printer manually.

The UPLOAD command will always place a header and a footer into the uploaded data. This header will be the DOWNLOAD command followed by the configuration number. The footer will be the DOWNLOAD END command. The operator should be aware that the UPLOAD and DOWNLOAD commands use a secondary copy of the menu structure which does not affect the printer's active configuration. This allows the UPLOAD and DOWNLOAD commands to operate without affecting the printer's current configuration. If the operator intends to use one of the DOWNLOADED configurations, the operator should reboot the printer to ensure proper operation. This can be accomplished by adding the RESET command as the last command in your setup file. This is necessary because the printer caches the active configuration. Rebooting the printer ensures that the desired configuration is correctly read from FLASH.

**NOTE:** While an upload or download is in progress, the Front Panel will be unavailable.

The Configuration Save and Delete commands from the front panel can be blocked by using the Protect Configurations feature. This is intended to prevent someone from inadvertently reconfiguring a printer. The PTX\_SETUP commands, however, will override the protect configurations feature. All PTX\_SETUP commands will be honored regardless of the value of the Protect Configurations feature.

## Operation of the FILE\_IO Command

When a file is opened for writing with the FILE\_IO-CAPTURE;*filename* command, the system will allocate RAM for file control blocks and 1 Kbyte for data. If the file already exists on the Flash File System and the Overwrite Enable feature in the Flash File System menu is set to disable, a warning will be displayed on the front panel. After clearing the warning, the file data will be printed. To overwrite the existing file, set the Overwrite Files option to enable.

Due to the nature of writing to flash, any data intended to be stored permanently in flash must first be copied into RAM. As a result, the ability to manipulate files in the Flash File System is dependent upon the printer having sufficient RAM. None of the captured file data will be committed to flash until the entire file is loaded. The PTX\_SETUP parser will interpret the command "FILE\_IO-CAPTURE<lf>" as an end of file marker. Receipt of the command will cause all file data to be written to flash. The file system allocates RAM for temporary data storage in 1 Kbyte blocks. If at any time during the file download the printer runs out of RAM, a warning will be displayed on the front panel and as much of the file as possible will be saved in flash.

Three things can limit the ability to save a file: insufficient RAM, insufficient Flash, and lack of empty file system entries. Flash can only be written once before it needs to be "optimized". As a result, the maximum file size is limited to the largest unwritten block of Flash. If any of these problems occur, the printer will display an error message and will attempt to provide the operator with a description of what steps to take to correct the error. Normally, the solution will involve optimizing the Flash File System. This can be accomplished by selecting the Optimize & Reboot function in the Flash File System menu under the ADVANCED USER menu, "Main File System."

**NOTE:** After selecting the Optimize & Reboot function, do not shut off the printer's power until after the printer returns to the power-on state. Loss of power during the optimize process may corrupt the printer's program. If this occurs, first attempt to repeat the downloading process. If that fails, contact an authorized service representative.



## Line Matrix Commands

Table 28 lists PTX\_SETUP commands which apply to line matrix printers only.

**Table 28 Line Matrix PTX\_SETUP Commands**

Command	Sub-Command	Parameter	Description
ENGINE	EJECT		Performs a page eject.



# F *Customer Support*

## Printronix Customer Support Center

**IMPORTANT** Please have the following information available prior to calling the Printronix Customer Support Center:

- Model number
- Serial number (located on the back of the printer)
- Installed options (i.e., interface and host type if applicable to the problem)
- Configuration printout: Press **CONFIG** on the control panel, then press the **ENTER** (↵) key.
- Is the problem with a new install or an existing printer?
- Description of the problem (be specific)
- Good and bad samples that clearly show the problem (faxing or emailing of these samples may be required)

Americas	(714) 368-2686
Europe, Middle East, and Africa	(31) 24 6489 311
Asia Pacific	(65) 6548 4114
China	(86) 800-999-6836

<http://www.primtronix.com/support.aspx>

## Printronix Supplies Department

Contact the Printronix Supplies Department for genuine Printronix supplies.

Americas	(800) 733-1900
Europe, Middle East, and Africa	(33) 1 46 25 19 07
Asia Pacific	(65) 6548 4100
China	(86) 400-886-5598

<http://www.primtronix.com/supplies-parts.aspx>

## Corporate Offices

Printronix, LLC.  
15345 Barranca Parkway  
Irvine, CA 92618  
U.S.A.  
Phone: (714) 368-2300  
Fax: (714) 368-2600

Printronix LLC.  
c/o Printronix Nederland BV  
Bijsterhuizen 11-38  
6546 AS Nijmegen  
The Netherlands  
Phone: (31) 24 6489489  
Fax: (31) 24 6489499

Printronix Schweiz GmbH  
3 Changi Business Park Vista  
#04-05 AkzoNobel House  
Singapore 486051  
Phone: (65) 6548 4100  
Fax: (65) 6548 4111

Printronix Commercial (Shanghai) Co. Ltd  
Room 903, 9<sup>th</sup> Floor  
No.199, North Xizang Road  
200070 Shanghai P.R.China  
Phone: (86) 400 886 5598  
Fax: (8621) 61171256

Printronix India Pvt Ltd  
B-808/809, BSEL Tech Park  
8<sup>th</sup> Floor, Sector 30A  
Vashi Navi Mumbai 400705  
India  
Toll Free No.: 1800 102 7896  
Fax: (9122) 4158 5555

Visit the Printronix web site at [www.printronix.com](http://www.printronix.com)

# G *Communication Notices*

## Notices

This information was developed for products and services offered in the U.S.A.

Printronix may not offer the products, services, or features discussed in this document in other countries. Consult your Printronix representative for information on the products and services currently available in your area. Any reference to an Printronix product, program, or service is not intended to state or imply that only that Printronix product, program, or service may be used. Any functionally equivalent product, program, or service that does not infringe any Printronix intellectual property rights may be used instead. However, it is the user's responsibility to evaluate and verify the operation of any non- Printronix product, program, or service.

Printronix may have patents or pending patent applications covering subject matter described in this document. The furnishing of this document does not give you any license to these patents. You can send license inquires, in writing, to:

Printronix, LLC  
15345 Barranca Parkway  
Irvine, CA 92618 U.S.A.

**The following paragraph does not apply to the United Kingdom or any other country where such provisions are inconsistent with local law:**

PRINTRONIX PROVIDES THIS PUBLICATION "AS IS" WITHOUT WARRANTY OF ANY KIND, EITHER EXPRESS OR IMPLIED, INCLUDING, BUT NOT LIMITED TO, THE IMPLIED WARRANTIES OF NON-INFRINGEMENT, MERCHANTABILITY OR FITNESS FOR A PARTICULAR PURPOSE. Some states do not allow disclaimer of express or implied warranties in certain transactions, therefore, this statement may not apply to you.

This information could include technical inaccuracies or typographical errors. Changes are periodically made to the information herein; these changes will be incorporated in new editions of the publication. Printronix may make improvements and/or changes in the product(s) described in this publication at any time without notice.

Any references in this information to non-Printronix Web sites are provided for convenience only and do not in any manner serve as an endorsement of those Web sites. The materials at those Web sites are not part of the materials for this Printronix product and use of those Web sites is at your own risk.

Any performance data contained herein was determined in a controlled environment. Therefore, the results obtained in other operating environments may vary significantly. Some measurements may have been made on development-level systems and there is no guarantee that these measurements will be the same on generally available systems. Furthermore, some measurement may have been estimated through extrapolation. Actual results may vary. Users of this document should verify the applicable data for their specific environment.

Information concerning non-Printronix products was obtained from the suppliers of those products, their published announcements or other publicly available sources. Printronix has not tested those products and cannot confirm the accuracy of performance, compatibility or any other claims related to non-Printronix products. Questions on the capabilities of non-Printronix products should be addressed to the suppliers of those products.

Printronix encourages owners of information technology (IT) equipment to responsibly recycle their equipment when it is no longer needed. Printronix offers a variety of programs and services to assist equipment owners in recycling their IT products. Information on these product recycling offerings can be found on Printronix's Internet site at <http://www.primtronix.com>.

**Note!**

Before using this information and the product it supports, read the information and Communication Statements on page 326.

If you are viewing this information softcopy, the photographs and color illustrations may not appear.

For online versions of this book, we authorize you to:

- Copy, modify, and print the documentation contained on the media, for use within your enterprise, provided you reproduce the copyright notice, all warning statements, and other required statements on each copy or partial copy.
- Transfer the original unaltered copy of the documentation when you transfer the related Printronix product (which may be either machines you own, or programs, if the program's license terms permit a transfer). You must, at the same time, destroy all other copies of the documentation.

You are responsible for payment of any taxes, including personal property taxes, resulting from this authorization.

Your failure to comply with the terms above terminates this authorization. Upon termination, you must destroy your machine readable documentation.

## Communication Statements

### Federal Communications Commission (FCC) Statement

This equipment has been tested and found to comply with the limits for a Class A digital device, pursuant to Part 15 of the FCC Rules. These limits are designed to provide reasonable protection against harmful interference when the equipment is operated in a commercial environment. This equipment generates, uses, and can radiate radio frequency energy and, if not installed and used in accordance with the instructions, may cause harmful interference to radio communications. Operation of this equipment in a residential area is likely to cause harmful interference in which case the user will be required to correct the interference at his own expense.

Properly shielded and grounded cables and connectors must be used in order to meet FCC emission limits. Printronix is not responsible for any radio or television interference caused by using other than recommended cables and connectors or by unauthorized changes or modifications to this equipment. Unauthorized changes or modifications could void the user's authority to operate the equipment.

This device complies with Part 15 of the FCC Rules. Operation is subject to the following two conditions: (1) this device may not cause harmful interference, and (2) this device must accept any interference received, including interference that may cause undesired operation.

### European Union Conformity



This product is in compliance with the EU directives for safety, EMC, ROHS, REACH, and WEEE. Please refer to the Service and Support section at our web site ([www.primtronix.com](http://www.primtronix.com)) for the most up to Declarations of Conformity.

Printronix cannot accept responsibility for any failure to satisfy the protection requirements resulting from a non-recommended modification of the product, including the fitting of non-Printronix option cards.

This product has been tested and found to comply with the limits for Class A Information Technology Equipment according to European standard EN 55022. The limits for Class A equipment were derived for commercial and industrial environments to provide reasonable protection against interference with licensed communication devices.

#### **WARNING**

This is a Class A product. In a domestic environment this product may cause radio interference in which case the user may be required to take adequate measures.

Properly shielded and grounded cables and connectors must be used in order to reduce the potential for causing interference to radio and TV communications and to other electrical or electronic equipment. Printronix cannot accept responsibility for any interference caused by using other than recommended cables and connectors.

#### **Industry Canada Compliance Statement**

This Class A digital apparatus complies with Canadian ICES-003.

Cet appareil numérique de la classe A conformé à la norme NMB-003 du Canada.

#### **Statement of CISPR 22 Compliance**

**Attention:** This is a Class A Product. In a domestic environment this product may cause radio interference in which case the user may be required to take adequate measures.

#### **Japanese VCCI Class A**

この装置は、情報処理装置等電波障害自主規制協議会（VCCI）の基準に基づくクラスA情報技術装置です。この装置を家庭環境で使用すると電波妨害を引き起こすことがあります。この場合には使用者が適切な対策を講ずるよう要求されることがあります。

#### **German Conformity Statement**

##### **Handbuchtex: FCC class A entspricht: EMVG Klasse A**

Text Für alle in Deutschland vertriebenen EN 55022 Klasse A Geräte:

Zulassungsbescheinigung laut dem Deutschen Gesetz über die elektromagnetische Verträglichkeit von Geräten (EMVG) vom 18. September 1998 (bzw. der EMC EG Richtlinie 89/336):

Dieses Gerät ist berechtigt in Übereinstimmung mit dem Deutschen EMVG das EG-Konformitätszeichen – CE – zu führen. Verantwortlich für die Konformitätserklärung nach Paragraph 5 des EMVG ist die:

Printronix GmbH  
Goethering 56  
D-63067 Offenbach Germany

Informationen in Hinsicht EMVG Paragraph 4 Abs. (1) 4:

Das Gerät erfüllt die Schutzanforderungen nach EN 55024 und EN 55022 Klasse A.

EN 55022 Klasse A Geräte müssen mit folgendem Warnhinweis versehen werden: "Warnung: dies ist eine Einrichtung der Klasse A. Diese Einrichtung kann im Wohnbereich Funkstörungen verursachen; in diesem Fall kann vom Betreiber verlangt werden, angemessene Maßnahmen durchzuführen und dafür aufzukommen."

EN 55024 Hinweis:

Wird dieses Gerät in einer industriellen Umgebung betrieben (wie in EN 55024 festgelegt), dann kann es dabei eventuell gestört werden. In solch einem Fall ist der Abstand bzw. die Abschirmung zu der industriellen Störquelle zu übergrößen.

Anmerkung:

Um die Einhaltung des EMVG sicherzustellen sind die Geräte, wie in den Printronix Handbüchern angegeben, zu installieren und zu betreiben.

## China

### Declaration:

This is a Class A product. In a domestic environment this product may cause radio interference in which case the user may need to perform practical actions.

**此为A级产品。在生活环境中，该产品可能会造成无线电干扰。在这种情况下，可能需要用户对其干扰采取切实可行的措施。**

海拔高度和非热带性气候声明



仅适用于海拔 2000m 一下地区安全使用



仅适用于非热带气候条件下安全使用

LMPPLS, LMPPHS, LMPCLS, LMPCHS 系列

行列式打印机安全注意事项说明





為保護您的安全，使用本設備時，請遵循下列安全注意事項：

- 請依照設備上所有的警告與說明進行操作。
- 請確定電源的電壓與頻率符合設備的電氣等級標籤上指定的電壓與頻率。
- 請不要將任何物件塞入設備的開口。導電的異物可能會導致短路，引起火災、電擊、或設備損傷。
- 不要對本設備進行機械或電氣修改。對經過修改的產品的安全與法規符合性，不負任何責任。
- 不要阻礙或覆蓋產品的開口。永遠不要將產品放在靠近輻射來源或熱源的地方。未能依照這些指引，將可能導致過熱情況，影響產品的可靠性。
- 產品是設計來配合有中性地線的電源系統使用。為降低電擊風險，請不要將產品插入任何其他類型的電源系統。如果您不確定建物提供的電源類型，請向建物管理員或合格電氣技師尋求協助。
- 不是所有的電源線都有相同的電流等級，請千萬不要將隨附於您設備的電源線用在其他產品上。請勿在產品上使用家用延長電源線。對於那些有多條電源線的產品，請確認您將所有的電源線拔下後，才算將系統電源完全中斷。
- 甲類警語：

**警告使用者：**

這是甲類的資訊產品，在居住的環境中使用時，可能會造成射頻干擾，在這種情況下，使用者會被要求採取某些適當的對策。

## Taiwan

### Warning:

This is a Class A product. In a domestic environment this product may cause radio interference in which case the user will be required to take adequate measures.

### 警告使用者：

這是甲類的資訊產品，在居住的環境中使用時，可能會造成射頻干擾，在這種情況下，使用者會被要求採取某些適當的對策。

單元 Unit	鉛Lead (Pb)	汞Mercury (Hg)	鎘Cadmium (Cd)	六價鉻 Hexavalent chromium (Cr+6)	多溴聯苯 Polybrominated biphenyls (PBB)	多溴二苯醚 Polybrominated diphenyl ethers (PBDE)
Power supply	○	○	○	○	○	○
Power supply (Alternate)	○	○	○	○	○	○
Power Switch	○	○	○	○	○	○
Appliance Inlet	○	○	○	○	○	○
Shuttle Fan	○	○	○	○	○	○
Intake/Exhaust Fan	○	○	○	○	○	○
Cartridge Ribbon Stepper motor	○	○	○	○	○	○
Platen Stepper motor	○	○	○	○	○	○
Paper feed Stepper motor	○	○	○	○	○	○
Shuttle Motor	○	○	○	○	○	○
Printed wiring board	○	○	○	○	○	○
PCBA	○	○	○	○	○	○
Power supply Barrier	○	○	○	○	○	○
Enclosure Acoustic Foam	○	○	○	○	○	○
Shuttle Air Shroud	○	○	○	○	○	○
Enclosure Belt Cover	○	○	○	○	○	○
Enclosure Top Cover and Lid	○	○	○	○	○	○
Enclosure Window	○	○	○	○	○	○
Enclosure Chassis	○	○	○	○	○	○
Enclosure Control Panel	○	○	○	○	○	○
Connector Plug 3 position	○	○	○	○	○	○
Power cord	○	○	○	○	○	○

## **Korea**

### **Class A**

(Broadcasting Communication Equipment for Office Use)

As an electromagnetic wave equipment for office use (Class A), this equipment is intended to use in other than home area. Sellers or users need to take note of this.

#### **A 급 기기**

( 업무용 방송통신기자재 )

이 기기는 업무용 (A 급) 전자파적합기기로서 판매자 또는 사용자는 이 점을 주의하시기 바라며, 가정외의 지역에서 사용하는 것을 목적으로 합니다.

### **Class B**

(Broadcasting Communication Equipment for Home Use)

As an electromagnetic wave equipment for home use (Class B), this equipment is intended to use mainly for home use and may be used in all areas.

#### **B 급 기기**

( 가정용 방송통신기자재 )

이 기기는 가정용 (B 급) 전자파적합기기로서 주로 가정에서 사용하는 것을 목적으로 하며, 모든 지역에서 사용할 수 있습니다.

### **CAUTION:**

This product is equipped with a 3-wire power cord and plug for the user's safety. Use this power cord in conjunction with a properly grounded electrical outlet to avoid electrical shock.

# Software License Agreement

Your printer contains, among other software, Printronix operating software including, but not limited to the Embedded Configurable Operating System (the “eCos Software”) as embedded software. The terms of this Agreement apply only to the eCos Software, and all other embedded software supplied with the printer. You accept the terms of this Agreement by your initial use of your printer.

## eCos License

This file is part of eCos, the Embedded Configurable Operating System.

Copyright (C) 1998, 1999, 2000, 2001, 2002 Red Hat, Inc.

eCos is free software; you can redistribute it and/or modify it under the terms of the GNU General Public License as published by the Free Software Foundation; either version 2 or (at your option) any later version.

You should have received a copy of the GNU General Public License along with eCos; if not, write to the Free Software Foundation, Inc., 59 Temple Place, Suite 330, Boston, MA 02111-1307 USA.

eCos is distributed in the hope that it will be useful, but WITHOUT ANY WARRANTY; without even the implied warranty of MERCHANTABILITY or FITNESS FOR A PARTICULAR PURPOSE. See the GNU General Public License for more details.

As a special exception, if other files instantiate templates or use macros or inline functions from this file, or you compile this file and link it with other works to produce a work based on this file, this file does not by itself cause the resulting work to be covered by the GNU General Public License. However the source code for this file must still be made available in accordance with section (3) of the GNU General Public License.

This exception does not invalidate any other reasons why a work based on this file might be covered by the GNU General Public License.

Alternative licenses for eCos may be arranged by contacting Red Hat, Inc. at <http://sources.redhat.com/ecos/ecos-license/>

## GNU GENERAL PUBLIC LICENSE

Version 2, June 1991

Copyright (C) 1989, 1991 Free Software Foundation, Inc., 51 Franklin Street, Fifth Floor, Boston, MA 02110-1301 USA Everyone is permitted to copy and distribute verbatim copies of this license document, but changing it is not allowed.

### Preamble

The licenses for most software are designed to take away your freedom to share and change it. By contrast, the GNU General Public License is intended to guarantee your freedom to share and change free software--to make sure the software is free for all its users. This General Public License applies to most of the Free Software Foundation's software and to any other program whose authors commit to using it. (Some other Free Software Foundation software is covered by the GNU Lesser General Public License instead.) You can apply it to your programs, too.

When we speak of free software, we are referring to freedom, not price. Our General Public Licenses are designed to make sure that you have the freedom to distribute copies of free software (and charge for this service if you wish), that you receive source code or can get it if you want it, that you can change the software or use pieces of it in new free programs; and that you know you can do these things.

To protect your rights, we need to make restrictions that forbid anyone to deny you these rights or to ask you to surrender the rights. These restrictions translate to certain responsibilities for you if you distribute copies of the software, or if you modify it.

For example, if you distribute copies of such a program, whether gratis or for a fee, you must give the recipients all the rights that you have. You must make sure that they, too, receive or can get the source code. And you must show them these terms so they know their rights.

We protect your rights with two steps: (1) copyright the software, and (2) offer you this license which gives you legal permission to copy, distribute and/or modify the software.

Also, for each author's protection and ours, we want to make certain that everyone understands that there is no warranty for this free software. If the software is modified by someone else and passed on, we want its recipients to know that what they have is not the original, so that any problems introduced by others will not reflect on the original authors' reputation.

Finally, any free program is threatened constantly by software patents. We wish to avoid the danger that redistributors of a free program will individually obtain patent licenses, in effect making the program proprietary. To prevent this, we have made it clear that any patent must be licensed for everyone's free use or not licensed at all.

The precise terms and conditions for copying, distribution, and modification follow.

## **GNU GENERAL PUBLIC LICENSE**

### **TERMS AND CONDITIONS FOR COPYING, DISTRIBUTION, AND MODIFICATION**

This License applies to any program or other work which contains a notice placed by the copyright holder saying it may be distributed under the terms of this General Public License. The "Program", below, refers to any such program or work, and a "work based on the Program" means either the Program or any derivative work under copyright law: that is to say, a work containing the Program or a portion of it, either verbatim or with modifications and/or translated into another language. (Hereinafter, translation is included without limitation in the term "modification".) Each licensee is addressed as "you".

Activities other than copying, distribution and modification are not covered by this License; they are outside its scope. The act of running the Program is not restricted, and the output from the Program is covered only if its contents constitute a work based on the Program (independent of having been made by running the Program). Whether that is true depends on what the Program does.

1. You may copy and distribute verbatim copies of the Program's source code as you receive it, in any medium, provided that you conspicuously and appropriately publish on each copy an appropriate copyright notice and disclaimer of warranty; keep intact all the notices that refer to this License and to the absence of any warranty; and give any other recipients of the Program a copy of this License along with the Program.

You may charge a fee for the physical act of transferring a copy, and you may at your option offer warranty protection in exchange for a fee.

2. You may modify your copy or copies of the Program or any portion of it, thus forming a work based on the Program, and copy and distribute such modifications or work under the terms of Section 1 above, provided that you also meet all of these conditions:
  - a. You must cause the modified files to carry prominent notices stating that you changed the files and the date of any change.
  - b. You must cause any work that you distribute or publish, that in whole or in part contains or is derived from the Program or any part thereof, to be licensed as a whole at no charge to all third parties under the terms of this License.
  - c. If the modified program normally reads commands interactively when run, you must cause it, when started running for such interactive use in the most ordinary way, to print or display an announcement including an appropriate copyright notice and a notice that there is no warranty (or else, saying that you provide a warranty) and that users may redistribute the program under these conditions, and telling the user how to view a copy of this License. (Exception: if the Program itself is interactive but does not normally print such an announcement, your work based on the Program is not required to print an announcement.)

These requirements apply to the modified work as a whole. If identifiable sections of that work are not derived from the Program, and can be reasonably considered independent and separate works in themselves, then this License, and its terms, do not apply to those sections when you distribute them as separate works. But when you distribute the same sections as part of a whole which is a work based on the Program, the distribution of the whole must be on the terms of this License, whose permissions for other licensees extend to the entire whole, and thus to each and every part regardless of who wrote it.

Thus, it is not the intent of this section to claim rights or contest your rights to work written entirely by you; rather, the intent is to exercise the right to control the distribution of derivative or collective works based on the Program.

In addition, mere aggregation of another work not based on the Program with the Program (or with a work based on the Program) on a volume of a storage or distribution medium does not bring the other work under the scope of this License.

3. You may copy and distribute the Program (or a work based on it, under Section 2) in object code or executable form under the terms of Sections 1 and 2 above provided that you also do one of the following:
  - a. Accompany it with the complete corresponding machine-readable source code, which must be distributed under the terms of Sections 1 and 2 above on a medium customarily used for software interchange; or,
  - b. Accompany it with a written offer, valid for at least three years, to give any third party, for a charge no more than your cost of physically performing source distribution, a complete machine-readable copy of the corresponding source code, to be distributed under the terms of Sections 1 and 2 above on a medium customarily used for software interchange; or,
  - c. Accompany it with the information you received as to the offer to distribute corresponding source code. (This alternative is allowed only for noncommercial distribution and only if you received the program in object code or executable form with such an offer, in accord with Subsection b above.)

The source code for a work means the preferred form of the work for making modifications to it. For an executable work, complete source code means all the source code for all modules it contains, plus any associated interface definition files, plus the scripts used to control compilation and installation of the executable. However, as a special exception, the source code distributed need not include anything that is normally distributed (in either source or binary form) with the major components (compiler, kernel, and so on) of the operating system on which the executable runs, unless that component itself accompanies the executable.

If distribution of executable or object code is made by offering access to copy from a designated place, then offering equivalent access to copy the source code from the same place counts as distribution of the source code, even though third parties are not compelled to copy the source along with the object code.

4. You may not copy, modify, sublicense, or distribute the Program except as expressly provided under this License. Any attempt otherwise to copy, modify, sublicense or distribute the Program is void, and will automatically terminate your rights under this License. However, parties who have received copies, or rights, from you under this License will not have their licenses terminated so long as such parties remain in full compliance.
5. You are not required to accept this License, since you have not signed it. However, nothing else grants you permission to modify or distribute the Program or its derivative works. These actions are prohibited by law if you do not accept this License. Therefore, by modifying or distributing the Program (or any work based on the Program), you indicate your acceptance of this License to do so, and all its terms and conditions for copying, distributing or modifying the Program or works based on it.
6. Each time you redistribute the Program (or any work based on the Program), the recipient automatically receives a license from the original licensor to copy, distribute or modify the Program subject to these terms and conditions. You may not impose any further restrictions on the recipients'

exercise of the rights granted herein. You are not responsible for enforcing compliance by third parties to this License.

7. If, as a consequence of a court judgment or allegation of patent infringement or for any other reason (not limited to patent issues), conditions are imposed on you (whether by court order, agreement or otherwise) that contradict the conditions of this License, they do not excuse you from the conditions of this License. If you cannot distribute so as to satisfy simultaneously your obligations under this License and any other pertinent obligations, then as a consequence you may not distribute the Program at all. For example, if a patent license would not permit royalty-free redistribution of the Program by all those who receive copies directly or indirectly through you, then the only way you could satisfy both it and this License would be to refrain entirely from distribution of the Program.

If any portion of this section is held invalid or unenforceable under any particular circumstance, the balance of the section is intended to apply and the section as a whole is intended to apply in other circumstances.

It is not the purpose of this section to induce you to infringe any patents or other property right claims or to contest validity of any such claims; this section has the sole purpose of protecting the integrity of the free software distribution system, which is implemented by public license practices. Many people have made generous contributions to the wide range of software distributed through that system in reliance on consistent application of that system; it is up to the author/donor to decide if he or she is willing to distribute software through any other system and a licensee cannot impose that choice.

This section is intended to make thoroughly clear what is believed to be a consequence of the rest of this License.

8. If the distribution and/or use of the Program is restricted in certain countries either by patents or by copyrighted interfaces, the original copyright holder who places the Program under this License may add an explicit geographical distribution limitation excluding those countries, so that distribution is permitted only in or among countries not thus excluded. In such case, this License incorporates the limitation as if written in the body of this License.
9. The Free Software Foundation may publish revised and/or new versions of the General Public License from time to time. Such new versions will be similar in spirit to the present version, but may differ in detail to address new problems or concerns.

Each version is given a distinguishing version number. If the Program specifies a version number of this License which applies to it and "any later version", you have the option of following the terms and conditions either of that version or of any later version published by the Free Software Foundation. If the Program does not specify a version number of this License, you may choose any version ever published by the Free Software Foundation.

10. If you wish to incorporate parts of the Program into other free programs whose distribution conditions are different, write to the author to ask for permission. For software which is copyrighted by the Free Software Foundation, write to the Free Software Foundation; we sometimes make exceptions for this. Our decision will be guided by the two goals of preserving the free status of all derivatives of our free software and of promoting the sharing and reuse of software generally.

## **NO WARRANTY**

11. BECAUSE THE PROGRAM IS LICENSED FREE OF CHARGE, THERE IS NO WARRANTY FOR THE PROGRAM, TO THE EXTENT PERMITTED BY APPLICABLE LAW. EXCEPT WHEN OTHERWISE STATED IN WRITING THE COPYRIGHT HOLDERS AND/OR OTHER PARTIES PROVIDE THE PROGRAM "AS IS" WITHOUT WARRANTY OF ANY KIND, EITHER EXPRESSED OR IMPLIED, INCLUDING, BUT NOT LIMITED TO, THE IMPLIED WARRANTIES OF MERCHANTABILITY AND FITNESS FOR A PARTICULAR PURPOSE. THE ENTIRE RISK AS TO THE QUALITY AND PERFORMANCE OF THE PROGRAM IS WITH YOU. SHOULD THE PROGRAM PROVE DEFECTIVE, YOU ASSUME THE COST OF ALL NECESSARY SERVICING,

## REPAIR OR CORRECTION

12. IN NO EVENT UNLESS REQUIRED BY APPLICABLE LAW OR AGREED TO IN WRITING WILL ANY COPYRIGHT HOLDER, OR ANY OTHER PARTY WHO MAY MODIFY AND/OR REDISTRIBUTE THE PROGRAM AS PERMITTED ABOVE, BE LIABLE TO YOU FOR DAMAGES, INCLUDING ANY GENERAL, SPECIAL, INCIDENTAL OR CONSEQUENTIAL DAMAGES ARISING OUT OF THE USE OR INABILITY TO USE THE PROGRAM (INCLUDING BUT NOT LIMITED TO LOSS OF DATA OR DATA BEING RENDERED INACCURATE OR LOSSES SUSTAINED BY YOU OR THIRD PARTIES OR A FAILURE OF THE PROGRAM TO OPERATE WITH ANY OTHER PROGRAMS), EVEN IF SUCH HOLDER OR OTHER PARTY HAS BEEN ADVISED OF THE POSSIBILITY OF SUCH DAMAGES.

END OF TERMS AND CONDITIONS

### Artifex Portions Software Copyright Notices

Portions Copyright © 2001/2009 Artifex Software Inc.

This software is based in part on the work of the Independent JPEG Group.

Portions Copyright © 1998 Soft Horizons.

All Rights Reserved.

### BSD License

Portions of this software may have been derived from OpenBSD, FreeBSD or other sources, and are covered by the appropriate copyright disclaimers included herein.

Portions created by Red Hat are Copyright (C) 2002 Red Hat, Inc. All Rights Reserved.

Copyright (c) 1982, 1986, 1988, 1990, 1993, 1994, 1995 The Regents of the University of California. All rights reserved.

Redistribution and use in source and binary forms, with or without modification, are permitted provided that the following conditions are met:

1. Redistributions of source code must retain the above copyright notice, this list of conditions and the following disclaimer.
2. Redistributions in binary form must reproduce the above copyright notice, this list of conditions and the following disclaimer in the documentation and/or other materials provided with the distribution.
3. All advertising materials mentioning features or use of this software must display the following acknowledgement: This product includes software developed by the University of California, Berkeley and its contributors.
4. Neither the name of the University nor the names of its contributors may be used to endorse or promote products derived from this software without specific prior written permission.

THIS SOFTWARE IS PROVIDED BY THE REGENTS AND CONTRIBUTORS "AS IS" AND ANY EXPRESS OR IMPLIED WARRANTIES, INCLUDING, BUT NOT LIMITED TO, THE IMPLIED WARRANTIES OF MERCHANTABILITY AND FITNESS FOR A PARTICULAR PURPOSE ARE DISCLAIMED. IN NO EVENT SHALL THE REGENTS OR CONTRIBUTORS BE LIABLE FOR ANY DIRECT, INDIRECT, INCIDENTAL, SPECIAL, EXEMPLARY, OR CONSEQUENTIAL DAMAGES (INCLUDING, BUT NOT LIMITED TO, PROCUREMENT OF SUBSTITUTE GOODS OR SERVICES; LOSS OF USE, DATA, OR PROFITS; OR BUSINESS INTERRUPTION) HOWEVER CAUSED AND ON ANY THEORY OF LIABILITY, WHETHER IN CONTRACT, STRICT LIABILITY, OR TORT (INCLUDING NEGLIGENCE OR OTHERWISE) ARISING IN ANY WAY OUT OF THE USE OF THIS SOFTWARE, EVEN IF ADVISED OF THE POSSIBILITY OF SUCH DAMAGE

**256381-001 H**